



ISBN: 978-604-84-2640-8

# PROCEEDINGS

INTERNATIONAL CONFERENCE

FOR YOUNG RESEARCHERS IN ECONOMICS AND BUSINESS

**(ICYREB 2017)**

Danang, October 30, 2017

DA NANG PUBLISHING HOUSE



ISBN: 978-604-84-2640-8

**PROCEEDINGS**

**INTERNATIONAL CONFERENCE**

**FOR YOUNG RESEARCHERS IN ECONOMICS**

**AND BUSINESS**

**(ICYREB 2017)**

**Danang, October 30, 2017**

**INTERNATIONAL CONFERENCE  
FOR YOUNG RESEARCHERS IN ECONOMICS AND BUSINESS  
(ICYREB 2017)**

---

**Responsible for Publishing**

Director: Truong Cong Bao

Editor-in-chief: Nguyen Kim Huy

Copyediting: Nguyen Thuy An

Typesetting and layout: ABLINE Co., Ltd

Proofing: Hung Tien



## Keynote Speakers

**Professor Duc Khuong Nguyen**, Professor of Finance and Deputy Director for Research at the IPAG Business School (France)

Professor Duc Khuong Nguyen holds a MSc and a PhD in Finance from the University of Grenoble Alpes (France) and obtains his HDR (Habilitation for Supervising Doctoral Research) in Management Sciences in June 2009. He also completed the "Leaders in Development" program at Harvard University, John F. Kennedy School of Government, Executive Education (2013). In January 2013, he joined IPAG Business School as Professor of Finance and Deputy Director for Research. Before joining IPAG Business School, he served as Professor of Finance and Head of the Department of Finance and Information Systems at ISC Paris Business School (2006-2012), as Assistant Professor of Finance and Grenoble Graduate Institute of Business (2005-2006), and Research and Teaching Assistant at EM Lyon Business School (2003-2005).



Professor Khuong is also a Non-Resident Research Fellow at the School of Public and Environmental Affairs, Indiana University, a Visiting Professor at Vietnam National University, Hanoi - International School and was a Research Associate at the Department of Finance, Centre d'Economie de la Sorbonne (CES), University Paris 1 Panthéon-Sorbonne (2011-2015).

His principal research areas concern emerging markets finance, energy finance, volatility modeling and risk management in international capital markets. His most recent articles are forthcoming and published in refereed journals such as European Journal of Operational Research, Journal of Banking and Finance, Journal of International Financial Markets, Institutions and Money, Journal of International Money and Finance, Journal of Macroeconomics, Journal of the Operational Research Society, Macroeconomic Dynamics, Quarterly Review of Economics and Finance, Review of International Economics, Review of Quantitative Finance and Accounting, and World Economy.



**Professor Eric D. Ramstetter**, Research Professor of Economics at Asian Growth Research Institute, Editor of Asian Economic Journal

Professor Ramstetter holds a PhD in Economic Development and International Economics from University of Colorado, USA. He has been working as a research professor for Asian Growth Research Institute since 1998 and lecturing at Kyushu University since 2000. He joined the editorial board of Asian Economic Journal in 1996 and is currently serving as the editor for this journal. His research interests relate to multinational enterprises, Asian economies, economic development, international economics and economic policy.

Professor Ramstetter is an economist with deep insights into multinational enterprises in Asian economies. He has been the member of many associations such as East Asian Economic Association, American Economic Association, Academy of International Business, Japan Economic Association and Japan Society of International Economics. Over the past few years, he led three

important research projects on Asian economies: Market Structure and Firm Performance in East Asia's Developing Economies (04/2005 – 03/2007), Ownership and Firm- or Plant-level Energy Efficiency in Southeast Asia (10/2010 – 03/2012) and Multinationals, Wages, and Human Resources in Southeast Asia's Large Developing Economies (04/2011-10/2015). He has been collaborating with several economists and researchers from different Asian countries, including Viet Nam, Thailand, Malaysia and China to do research and publish their research papers in refereed journals such as Global Economic Review: Perspectives on East Asian Economies and Industries, Asian Economic Journal, Asian Economic Papers, Journal of Asian Economics, Singapore Economic Review, Asia Pacific Economic Literature, Emerging Markets Finance and Trade, Asian Development Review,...

**Professor Sushil Sharma**, Associate Dean of the Miller College of Business, Ball State University, USA

Professor Sushil Sharma is currently an associate dean and a professor of computer information systems (CIS) in the Miller College of Business at Ball State University. Professor Sharma has the unique distinction of earning two doctoral degrees. His primary research interests are in computer information systems security, e-Learning, e-Government, computer-mediated communications, human computer interaction (HCI) and community and social informatics.



Since 2007, Professor Sharma has served as the editor-in-chief/co-editor-in-chief of the International Journal of E-Adoption. He has been a guest editor, associate editor, reviewer and member of the editorial boards for several national and international journals in the area of MIS. Professor Sharma has co-authored/edited/co-edited twelve (12) books and published over ninety (90) refereed research papers in the most reputed national and international MIS journals. In addition, he has published forty-five (45) refereed chapters in various books and has presented and published over 135 papers in various national and international conferences. Professor Sharma's research has appeared in several highly ranked journals in the MIS field, including Decision Support Systems, Communications of the Association for Information Systems, European Journal of Information Systems, Information Systems Frontiers, Journal of Information Privacy & Security (JIPS), Electronic Commerce Research Journal, and Information Management and Computer Security.

Professor Sharma has been the recipient of several research grants and has also won numerous professional honors. He received a Citation of Excellence as the author of one of the top fifty Management articles of 2002 for the paper "Securing Information Infrastructure from Information Warfare", Logistics Information Management, Vol. 15, No. 5/6, 2002. He also received the Instructional Innovation Award from the Southwest Decision Sciences Institute in 2003 and the Best Paper Award by the Midwest Association of Information Systems in 2012. He has been a featured keynote speaker for hundreds of professional forums, executive development seminars, and academic conferences worldwide on a wide variety of topics of computer information systems and management. Professor Sharma has also served as a consultant and advisor to numerous companies and organizations, including World Bank funded projects.

Professor Sharma has traveled worldwide and lectured in several business schools around the globe in Europe, Australia, New Zealand, Asia, and North America.



## Steering Committee

- |   |  |
|---|--|
| 1. Assoc. Prof. Dr. <b>Nguyen Manh Toan</b>     | Rector of University of Economics – University of Da Nang                          |
| 2. Assoc. Prof. Dr. <b>Vo Thi Thuy Anh</b>      | Vice rector of University of Economics – University of Da Nang                     |
| 3. Prof. Dr. <b>Dinh Van Son</b>                | Rector of Thuong Mai University  |
| 4. Prof. Dr. <b>Nguyen Trong Hoai</b>           | Vice rector of University of Economics Ho Chi Minh City                            |
| 5. Assoc. Prof. Dr. <b>Tran Thi Van Hoa</b>     | Vice rector of National Economics University                                       |
| 6. Assoc. Prof. Dr. <b>Do Thi Kim Hao</b>       | Vice president of Banking Academy  |
| 7. Assoc. Prof. Dr. <b>Hoang Cong Gia Khanh</b> | Vice rector of University of Economics and Law                                     |
| 8. Assoc. Prof. Dr. <b>Nguyen Thi Bich Loan</b> | Vice rector of Thuong mai University   |
| 9. Assoc. Prof. Dr. <b>Pham Van Lien</b>        | Vice president of Academy of Finance   |
| 10. Assoc. Prof. Dr. <b>Nguyen Thu Thuy</b>     | Vice rector of Foreign Trade University  |
| 11. Dr. <b>Truong Tan Quan</b>                  | Vice rector of Hue College of Economics – Hue University                           |
| 12. Dr. <b>Nguyen Anh Thu</b>                   | Vice rector of University of Economics and Business – Viet Nam National University |

## Organizing Committee

- |   |  |
|---|--|
| 1. Assoc. Prof. Dr. <b>Vo Thi Thuy Anh</b>    | Vice rector of University of Economics – University of Da Nang |
| 2. Assoc. Prof. Dr. <b>Nguyen Phuc Nguyen</b> | University of Economics – University of Da Nang                |
| 3. Assoc. Prof. Dr. <b>Pham Thi Hoang Anh</b> | Banking Academy  |
| 4. Assoc. Prof. Dr. <b>Tran Tien Khai</b>     | University of Economics Ho Chi Minh City                       |
| 5. Assoc. Prof. Dr. <b>Vu Hoang Nam</b>       | Foreign Trade University                                       |
| 6. Assoc. Prof. Dr. <b>Hoang Tung</b>         | University of Economics – University of Da Nang                |
| 7. Assoc. Prof. Dr. <b>Trinh Quoc Trung</b>   | University of Economics and Law                                |



- |  |   |
|--|---|
| 8. Assoc. Prof. Dr. <b>Nguyen Hoang Viet</b> | Thuong Mai University   |
| 9. Dr. <b>Nguyen Thi Vu Ha</b>               | University of Economics and Business – Viet Nam National University |
| 10. Dr. <b>Ngo Thanh Hoang</b>               | Academy of Finance  |
| 11. Dr. <b>Pham Xuan Hung</b>                | Hue College of Economics – Hue University                           |
| 12. Dr. <b>Trinh Mai Van</b>                 | National Economics University                                       |
| 13. M.Sc. <b>Dang Ngoc Chau</b>              | University of Economics – University of Da Nang                     |
| 14. M.Sc. <b>Tran Quoc Hung</b>              | University of Economics – University of Da Nang                     |
| 15. M.Sc. <b>Phan Kim Tuan</b>               | University of Economics – University of Da Nang                     |
| 16. Mrs. <b>Hong Thi Thuy</b>                | University of Economics – University of Da Nang                     |

## Scientific Committee

- |   |  |
|---|--|
| 1. Assoc. Prof. Dr. <b>Dao Huu Hoa</b>        | Vice rector of University of Economics – University of Da Nang (UE-UD) |
| 2. Dr. <b>Nguyen Trung Kien</b>               | UE-UD  |
| 3. Dr. <b>Ninh Thi Thu Thuy</b>               | UE-UD  |
| 4. Prof. Dr. <b>Tran Ngoc Tho</b>             | University of Economics Ho Chi Minh City                               |
| 5. Assoc. Prof. Dr. <b>Pham Duc Chinh</b>     | University of Economics and Law  |
| 6. Assoc. Prof. Dr. <b>Nguyen Chi Hai</b>     | University of Economics and Law  |
| 7. Assoc. Prof. Dr. <b>Le Quoc Hoi</b>        | National Economics University  |
| 8. Assoc. Prof. Dr. <b>Le Thi Lan Huong</b>   | National Economics University  |
| 9. Assoc. Prof. Dr. <b>Vu Hoang Nam</b>       | Foreign Trade University   |
| 10. Assoc. Prof. Dr. <b>Hoang Thuy Nguyet</b> | Academy of Finance   |
| 11. Assoc. Prof. Dr. <b>Le Thai Phong</b>     | Foreign Trade University   |
| 12. Assoc. Prof. Dr. <b>Nguyen Hoang Viet</b> | Thuong Mai University  |
| 13. Dr. <b>Phan Chi Anh</b>                   | University of Economics and Business – Viet Nam National University    |



- |   |   |
|---|---|
| 14. Dr. <b>Le Tien Dat</b>                        | Thuong Mai University   |
| 15. Dr. <b>Phan Thanh Duc</b>                     | Banking Academy   |
| 16. Dr. <b>Nguyen Van Ha</b>                      | Banking Academy   |
| 17. Dr. <b>Nguyen Thi Vu Ha</b>                   | University of Economics and Business – Viet Nam National University |
| 18. Dr. <b>Pham Xuan Hung</b>                     | Hue College of Economics – Hue University                           |
| 19. Dr. <b>Vu Van Huong</b>                       | Academy of Finance  |
| 20. Dr. <b>Ho Thi Huong Lan</b>                   | Hue College of Economics – Hue University                           |
| 21. Dr. <b>Pham Khanh Nam</b>                     | University of Economics Ho Chi Minh City                            |
| 22. Assoc. Prof. Dr. <b>Tran Dinh Khoi Nguyen</b> | UE-UD   |
| 23. Prof. Dr. <b>Nguyen Truong Son</b>            | UE-UD   |
| 24. Assoc. Prof. Dr. <b>Doan Ngoc Phi Anh</b>     | UE-UD   |
| 25. Assoc. Prof. Dr. <b>Le Huu Ai</b>             | UE-UD   |
| 26. Assoc. Prof. Dr. <b>Lam Chi Dung</b>          | UE-UD   |
| 27. Assoc. Prof. Dr. <b>Pham Thi Lan Huong</b>    | UE-UD   |
| 28. Dr. <b>Tran Ngoc Anh</b>                      | UE-UD   |
| 29. Dr. <b>Le Dan</b>                             | UE-UD   |
| 30. Dr. <b>Dang Tung Lam</b>                      | UE-UD   |
| 31. Dr. <b>Truong Sy Quy</b>                      | UE-UD   |



**ICYREB 2017**

# Table of Contents

No	Paper title	Authors	Page
1	Audit quality and earnings quality: Empirical evidence from Vietnam	Nguyen Vinh Khuong Phung Anh Thu	1
2	Personalization in The Age of Internet of Things: Implications for Vietnamese Enterprises	Dung Phuong Hoang	11
3	Prediction of Financial Distress for Companies Listed in Vietnam Securities Market	Vu Thi Loan	21
4	Social Enterprise in Vietnam – Opportunities, Challenges and Solutions	Le Ngoc Dang	29
5	Crowding Out Effects of Public Spending on Private Investment – An Evidence from Vietnam	Le Viet An	36
6	Industry 4.0 and Innovative Opportunities for Logistics Sector	Mai Tran Thi Phuong Ninh Vu Viet	46
7	Financial Enterprise Risks and Firm Performance: Case Study in Construction Sector in Vietnam	Luu Huu Duc Diem T.T Hai	52
8	Apply an Integrated Animosity Model to Research Customer Behavior. A Study in Vietnam towards China Food	Tran Xuan Quynh	60
9	Determinants of Employee Work Innovation: Critically Review and Integrated Model	Pham Hong Liem	69
10	Adapting Digital Technology to Accelerate Financial Inclusion: The Case of Vietnam Banking Sector	Tran Nguyen Minh Hai	77
11	Measuring Misalignment between Vietnam and The United States Through Purchasing Power Parity	Tran Quoc Khanh Cuong Pham Hoang An Nguyen Dang Hat	87
12	Financial Supervision Unification and Central Bank Involvement in Supervision: Evidence from Before and After 2008 Global Financial Crisis	Pham Thi Thuy Diem	94
13	Rethinking about Vietnam Educational Reform in The Context of The Fourth Industrial Revolution	Thang Duong Duc Hong Nguyen Anh	102

14	Factors Influencing Mobile Banking Adoption in Ho Chi Minh City Based on The Technology Acceptance Model	Nguyen Dang Hai Yen	110
15	Brand Image of Retailer in Electronic Consumer: The Study of Pico and Mobile World	NGUYEN Thu Huong DAO Cao Son LE Thi Duyen	118
16	Determinants of Banks' Profitability: Empirical Evidence from Listed Banks in Vietnam	Phan Dai Thich	128
17	Effects of Organizational Culture to Employees' Satisfaction and Cohesion in Tourism Accommodation Enterprises of Thanh Hoa Province	Le Thi Binh Pham Thi Bich Thu	135
18	The Impacts of The 4 <sup>th</sup> Industrial Revolution on Vietnamese Businesses	Mai Mai	147
19	Finance – Growth Nexus in Developing Countries: Threshold or Not	Bui Thanh Trung Nguyen Thi Thanh Van Le Thi Thuy Hang	151
20	The Challenges of The Development of Social Enterprises in Vietnam	Phan Hong Mai Nguyen Ngoc Dung	158
21	Research on Fraud Risk Factors Affecting Fraudulent Financial Reporting of Non-Financial Companies Listed on Vietnam's Stock Market	Ta Thu Trang Doan Thanh Nga	163
22	Influence of Ownership Structure on Systemic Risk of Vietnam Listed Commercial Banks	Vu Thi Thuy Van Phan Trong Nghia Bui Thi Thuy Anh	171
23	Solutions to Well Attract Vietnamese Customers' Attention to TV Advertising	Nguyen Thi Huyen Tran Nguyen Thi Thu Ha Ha Hien Minh	179
24	Influence of Share Repurchases on Profitability– A Case Study of Taiwan and Implication	Nguyen Thi Huyen Tran Nguyen Thi Thu Ha Nguyen Duc Vinh	187
25	Factors Affecting to The Success of The Contemporary Management Accounting Practices in Vietnamese Enterprises	Do Huyen Trang Le Mong Huyen	194
26	Family Business Enterprises in International Trade – The Family Involvement and The Internationalization of The Companies	Nguyen Thi Thu Ha	203

27	Partial-Credit-Constraint and Complete-Credit-Constraint of Small and Medium Enterprises in Vietnam	Phan Dinh Khoi Phan Ly Ngoc Thao	210
28	The Fourth Industrial Revolution: Fundamental Factors for The Transition of Vietnam's Industry	Nguyen Thai Hoa	223
29	Developing scientific tourism in Binh Dinh Province: Launching from International Center for Interdisciplinary Science and Education (ICISE)	Dang Thi Thanh Loan	235
30	Factors Influencing the Usage of Balanced Scorecard for Performance Measurement in Enterprises in Viet Nam	Hoang Van Tuong Dinh Hoai Nam Nguy Thu Hien	242
31	Purchase Intention towards Green Products Selling at Supermarkets in Ho Chi Minh City, Vietnam	Nguyen Tuan Duong Le Huu Phuoc Nguyen Huynh Ngoc Tram	254
32	Analysis of Factors Affecting The Income of Households Making GI Products: A Case Study of Ha Long Grilled Squid - Quang Ninh Province	Nguyen Van Thinh	264
33	Interface between Competition Law and Intellectual Property Law in the Enforcement of Intellectual Property Right in Vietnam	Bui Thi Hang Nga Huynh Van Hung Le Thi Diem	271
34	The Forth Industrial Revolution: Opportunities and Challenges Posing For 4 and 5-Star Rated Hotels in Vietnam	Hoang Thi Thu Trang	276
35	Using Shannon Entropy to Measure The Volatility of Stock Market: An Empirical Study of Asean Countries	Tran Thi Tuan Anh	282
36	The Role of Price Consciousness in The Relationship between Prestige Sensitivity and Customer's Price Acceptance in Viet Nam Mobile Phone Market	Nguyen Thi Huyen	289
37	Foreign Direct Investment in Vietnam: Optimistic or Overrated?	Phung Thanh Quang	297
38	Factors Affecting Financial Performance of Firms in Context of The Fourth Industrial Revolution: Evidence From Information and Communication Technology Companies Listed in The Vietnamese Stock Market	Nguyen Thanh Dat Ta Dinh Hoa	303
39	A Study on Qualitative Characteristics of Accounting Information: The Case of New Accounting System for Small and Medium Sized Enterprises in Vietnam	Nguyen Thanh Hieu Ha Thi Phuong Dung Nguyen Huu Anh	310

40	Factors Affecting People's Intention to Use Urban Railways in Hanoi	Nguyen Thi Le Thuy Bui Thi Hong Viet Nguyen Duc Huy	318
41	Valuing Economic Impact of Climate Change on Catch Fisheries in Vietnam	Nguyen Thi Vinh Ha	325
42	Online Dispute Resolution – Experience for Vietnam	Nguyen Thi Hong Nhung	334
43	The Impact of State Ownership on Profitability of Vietnamese Commercial Banks	Vo Hoang Diem Trinh Le Thi To Nhu	338
44	Does Quantity Matter? The Role of Perceived Critical Mass on OTT Acceptance in Vietnam	Doan Thi Lien Huong	346
45	Developing Brand Personality Scale in A Vietnamese Context	Le Thi Minh Hang Bao Quoc Truong-Dinh	355
46	Enhancing The Social Efficiency of Hanoi's Foreign Direct Investment in The Context of The Industrial Revolution 4.0	Tran Thi Thanh Huyen Nguyen Duc Hoang Tho	365
47	KPI in Evaluating Organization's Recruitment and Selection Practices	Le Thi Khanh Ly	373
48	The Impact of FDI on Quality of Environment – Empirical Analysis For Six Asean Countries	Le Thi Hong Minh Hoang Thi Phuong Anh Tran Nguyen Dan Tran Thi Anh Thu	380
49	Determinants of Relationship Quality in The Context of The Industrial Zones in The Central Vietnam Key Economic Region	Duong Thi Lien Ha Vo Quang Tri	389
50	Antecedents and Consequences of The Initial Consumer Trust in The Context of Mobile Payment in Vietnam	Dang Thi Thu Trang	398
51	Interface Between Competition Law and Intellectual Property Law in The Enforcement of Intellectual Property Right in Vietnam	Tran Duc Tuan	406
52	The Impact of Real Exchange Rate and Some Macroeconomic Factors on Vietnam's Trade Balance: An ARDL Approach	Le Hoang Phong Ho Hoang Gia Bao Dang Thi Bach Van	410
53	Customer Behaviour of Using Internet Banking in The Fourth Industrial Revolution: A Study of Vietnam	Vo Thi Phuong	418

54	Determinants of Sustainability Reporting Quality: An Empirical Research on Vietnamese Listed Companies	Hoang Thi Mai Khanh Nguyen Anh Tuan	426
55	Risk Management at Mobile World Corporation	Le Thai Phong Le Do Thien Truc	438
56	Monetary Policy and Inequality in Vietnam: Implications for The Industrial Revolution 4.0	Ngoc Huong Vu Ha Thu Le	448
57	Corporate Debt Maturity Structure: Quantile Regression and Oaxaca-Blinder Decomposition Approaches	Nguyen Thanh Liem Nguyen Thi Canh Nguyen Thi Ngoc Diep	457
58	The Effect of FDI on Inequality-Adjusted HDI (IHDI) in Asian Countries	CAO Thi Hong Vinh TRINH Quynh Linh NGUYEN Thi An Ly	465
59	Developing Government Bond Portfolios at Commercial Banks by Barbell Strategy: A Case study in VPBank	Do Hoai Linh Nguyen Thanh Trung Le Phong Chau	475
60	Impact of ODA on Poverty Reduction in Viet Nam	Do Ngoc Lan	483
61	The Effects from The U.S. and Japan to Emerging Stock Markets in Asia and Vietnam	Nguyen Thi Ngan Nguyen Thi Diem Hien Hoang Trung Nghia	488
62	Vietnamese Enterprises with Technological Challenges When Integrate into The International Market	Nguyen Anh Tuan Nguyen Minh Thanh Tran Thi Loc	497
63	The Impact of Board Gender Diversity on Firm Performance: Evidence from Vietnamese listed firms	Hoang Thi Phuong Anh Pham Duc Anh Nguyen Ngoc Hong Trang	509
64	Cost Stickiness of Selling and Administration Expense: The Case of Vietnam	Dang Thi Huyen Huong Pham Thi Ngoc Thu Ngo Thi Hong Tham	516
65	Evaluating The Entrepreneurship Performance in Vietnam Through The GEDI (The Global Entrepreneurship Development Index) Approach	Nguyen Thi Thu Ha Lam Ba Hoa	522
66	Corporate Financial Strength and Sovereign Default Risk in Vietnam: Cross-sector Evidence from Vietnamese Public Companies	Thai Duy Tung	534
67	Determinants of Fund Raising for Vietnamese Startups	Le Thai Phong Nguyen Thi Hanh	543

68	The Timing of Financial Statement Publication and Stock Return: The Case of Vietnam	Nguyen Thi Ngoc Diep	552
69	Factors Affecting The Ability of Foreign Trade University Students from Three Campuses to Start Their Own Business	Tran Minh Thu	560
70	Carbon Leakage and The Legality of Border Carbon Adjustment: a Possible Approach through The Active Participation of Domestic Industries	Dao Gia Phuc	567
71	Exchange Rate Uncertainty and Export Flows: Evidence from 30 Countries	Huynh, Thi Dieu Linh	577
72	Young Consumers' OTT (Over-The-Top) Applications Usage and Potential Strategies for Telecompanies: A Case of Vietnam	Doan Thi Lien Huong Truong Duy Nhat Phuong	586
73	The Global Value Chains' S Participation of Vietnam with The Industrial Revolution 4.0	Dang Thi Huyen Anh	593
74	Investor - State Dispute Settlement in The Trans - Pacific Partnership Agreement	Bui Duy Linh Nguyen Thai Binh	599
75	Factors Affecting Outsourcing of Accounting of Enterprise Executives In Vietnam	Le Thi Tu Oanh Bui Thi Ngoc	607
76	Digital Banking Adoption: The Case of Vietnam	Nguyen Thi Thu Trang	617
77	The Impact of Foreign Direct Investment, Economic Growth and Energy Consumption on Carbon Dioxide Emission in 10 Asian Countries	Le Nguyen, Nguyen Hanh	627
78	Time Series Analysis for Improving Accuracy of Stock Price Forecasts Using Least Squares Support Vector Regression	Ngoc-Tri Ngo Thi Thu Ha Truong	637
79	Preparing for The Development of Digital Banking in Vietnam	Ngo Duc Tien	644
80	Solutions to Develop Tea Production Follow Good Agricultural Practice (GAP) Standard: Study at Thai Nguyen	Nguyen Nhu Trang Dang Phi Truong	651
81	Exploring Factors Influencing the Success of Crowdfunding Campaigns for Startups in Vietnam	Tran Thi Thanh Tu Dinh Phuong Anh Tang Thi Ha Thu	657

# Audit Quality And Earnings Quality: Empirical Evidence From Vietnam

Nguyen Vinh Khuong<sup>a\*</sup>, Phung Anh Thu<sup>b</sup>

<sup>a</sup>University of Economics and Law, Quarter 3, Linh Xuan Ward, Thu Duc District, Ho Chi Minh City, 700000, Vietnam

<sup>b</sup>Nguyen Tat Thanh University, No. 300A, Nguyen Tat Thanh Stress, Ward 13, District 4, Ho Chi Minh City, 700000, Vietnam

---

---

## ABSTRACT

Earnings quality has been a great and consistent concern among practitioners and regulators and has received considerable attention in the accounting literature. This study investigates the association between firm age, audit quality and earnings quality for Vietnam listed firms in an attempt to contribute to the recent debate. It selects the 284 most active firms in the Vietnam stock exchange and the analysis is done using the financial statements from the disclosure book for the period 2012-2015. Using quantitative research methods, findings found that there is a significant positive relationship between firm age on earnings quality while proxy variables of the audit quality have a significant negative relationship with earnings quality. This paper contributes to the financial accounting literature and the earnings quality literature.

**Keywords:** Audit Quality, Earnings Quality.

---

---

## 1. Introduction

Accounting earnings are perhaps the most widely used measure of firm performance. Given that accounting rules and financial reporting standards provide the executives of a firm with considerable opportunities for earnings management, it is not surprising that increasing attention in financial accounting literature has been devoted to the analysis of earnings management. It has been long acknowledged that firm's executives may have incentives to manipulate earnings in order to maximize firm value and/or their own wealth at the expense of shareholders (see e.g. Holthausen, 1990; Christie and Zimmerman, 1994; Beneish, 2001).

High quality financial reporting is highly appreciated by investors and other stakeholders for several reasons. One of them is that it reduces the information asymmetry problem as (Jensen and Meckling 1976) state in their research. In addition to that it provides users with more reliable information to take decisions and better reflection for the company (Waweru and Riro 2013). Moreover, as (Watts and Zimmerman 1978) add, high quality financial reporting boosts the level of transparency and helps in executing better contracts. Finally, the International Chamber of Commerce (ICC 2005) clarifies that the market efficiency and the confidence of the investors are enhanced when the reporting information is reliable and of high quality in the sense of consistency, comparability and understandability.

In this paper, we examine the association between earnings management and firm age, audit quality. The next section of the paper shows the literature and develops the research hypotheses; section 3 and 4 presents the methodology, section 5 is the findings and the conclusion, finally section 6 provides the limitations and few recommendations.

## 2. Literature Review and Hypotheses

There are numbers of factors that settle on earnings management of any firm. Many theories have been developed so far, enlightening the earnings management. Some theories are endowed with evidences that support the utilization of debt and some argues that equity is the best way of enhancing a firm's earnings management. Here, we will briefly review the literature that is the motivation of our research and is related to our study.

\* Corresponding author. Tel.: +84 935 997 116.  
E-mail address: khuongnv@uel.edu.vn



Agency theory provides a framework for organizing relationships through the contracting mechanism in which one party, the principal, hires another party, the agent, for purposes of delegating responsibility to the latter (Jensen and Meckling, 1976). For example, a CEO (the agent) is hired to do work on behalf of the shareholder (the principal), and a business-unit manager (the agent) is hired to do work on behalf of a senior executive (the principal). While the principal and agent may be engaged in cooperative behavior, they may also have differing goals and differing attitudes toward risk. Eisenhardt (1989) summarizes two problems that occur as a result of these differences. The risk sharing problem refers to situations where the principal and agent have different attitudes towards who should assume the risk for uncontrollable events (i.e., risk efficiency). Agency theory provides a conceptual framework for investigating the influence of contract incentives and information (a) symmetry on accounting decisions (Baiman, 1982; Eisenhardt, 1989). Such accounting decisions include, but are not limited to, determining the amount and timing of certain period ending accruals in situations where contractual outcomes (i.e., bonus incentives) explicitly depend on reported accounting numbers. While the structure of bonus incentives is meant to deal with risk and effort issues, Watts and Zimmerman (1986) also suggest that there are unexpected consequences related to bonus incentives. Such consequences include biasing managers' accounting decisions.

Earnings quality, earnings management and audit quality are three closely related concepts. The first concept, earnings quality, is equivalent to financial reporting quality and is a function of both the management and the auditor. The management is responsible for the (non-)financial information that they provide to the auditor, but both the auditor and the management are responsible for the (non-)financial information provided to outsiders. Earnings quality is defined by Dechow et al. (2010) as follows: "Higher quality earnings provide more information about the features of a firm's financial performance that are relevant to a specific decision made by a specific decision-maker." They mention that this definition alone is meaningless and therefore add three features. These features are that (1) earnings quality is defined only in the context of a specific decision model, (2) the quality of earnings depends on whether it is informative about the firm's financial performance, (3) earnings quality is jointly determined by the relevance of the underlying financial performance to the decision and by the ability of the accounting system to measure performance.

The second concept is audit quality. Several prior studies document an association between higher quality audits and higher quality of financial reporting, and thus earnings quality (Becker et al., 1998; Johnson et al., 2002; Myers et al., 2003; Ghosh and Moon., 2005). Audit quality is a function of inter alia client size, auditor size and industry specialization and expertise. With regard to the first factor, client size, Carcello and Nagy (2004) concluded that the negative relation between industry specialization and financial fraud is weaker for larger clients. Reynolds and Francis (2000) mention that large clients create economic dependence for auditors, so it is conceivable that auditors report more favorable to these valuable clients. However, they did not find evidence for this relation. But they did find that auditors report more conservative for larger clients, because larger clients pose more litigation risk. This suggests that reputation protection dominates auditor behavior, and this could influence the audit quality. Auditor size is another factor that influences the audit quality. DeAngelo (1981) concludes that when the auditor is larger, as measured by the number of clients, the incentive that the auditor behaves opportunistic is lower and the audit quality is higher. DeAngelo (1981) argues that larger auditors are subject to bigger losses when they fail to report discovered breach in the client's reports. This is because incumbent auditors earn a client-specific quasirent, so an auditor with more clients has more to lose. Another reason is that when auditors provide low quality audits by large clients, their reputation will decrease sharply when the client gets involved with scandals or fraud. This is because, in general, larger companies are followed by the media in a larger extent than smaller companies. With regard to industry specific knowledge, some studies mention that when auditors are specialized in a certain industry they gain more knowledge about that industry. They learn from clients in the same industry and share best practices across the industry (Maletta & Wright, 1996). Auditors specialize in various industries to achieve product differentiation and provide higher quality audits (Simuni & Stein, 1987). In industries with specialized contracts and accounting technologies, auditor industry specialization leads to a higher level of audit assurance (Craswell et al., 1995).

Using economic theory, DeAngelo (1981) argues that auditor size is a proxy for auditor reputation and audit quality, and that Big 4 auditors with valuable reputations at stake have more incentive to ensure that their clients' financial statements properly reflect the underlying transactions. Consistent with the notion that Big 4 auditors enhance the credibility of financial statements, prior studies document that Big 4 auditors are associated with higher financial reporting quality in public firms around the world (Francis and Wang, 2008; Kanagaretnam et al., 2010). Besides reputational concerns, extant theory and evidence indicates that Big N auditors provide more implicit insurance coverage in the event of audit failure (Watts and Zimmerman 1986; Mansi et al. 2004). In other words, Big 4 auditors with "deep pockets" have stronger incentives to lower the expected costs of litigation by supplying superior audits.

Earnings quality has a lot in common with the third concept, which is earnings management. Earnings management is defined by Healy and Wahlen (1999) as follows: "Earnings management occurs when managers use judgment in financial reporting and in structuring transactions to alter financial reports to either mislead some stakeholders about the underlying economic performance of the company or to influence contractual outcomes that depend on reported accounting numbers." Ball and Shivakumar (2004) conclude that low quality earnings are earnings

which are managed upwardly. However, low quality earnings could also be earnings that are managed downwardly to postpone earnings to next year to receive bonuses (Healy, 1985). As mentioned above, earnings quality is dependent on more factors than earnings management. When firms engage in earnings management, their earnings quality will be lower than when they do not engage in earnings management. Overall the three concepts, earnings quality, earnings management and audit quality are closely related. It does not make much of a difference which concept will be investigated because the conclusions that can be drawn with regard to one concept can be related and generalized to the other concepts. I have chosen to investigate earnings quality because I use the model from the research of Chen et al. (2008) and they use this concept.

Many studies used the above mentioned proxy “residuals from accruals” to measure earnings quality (Chen et al., 2008; Davis et al., 2007, Johnson et al., 2002, Myers et al., 2003). When accrual accounting is applied, earnings deviate from cash flows because, for example, revenue is reported when it is earned and not necessarily when the cash is received. There is a distinction between non-discretionary accruals and discretionary accruals. Non- discretionary accruals are accruals that are the result of normal operations. Discretionary accruals are accruals that are affected by the discretion of the management. This is the part of the accruals that can be affected by earnings management.

Dechow et al. (1995) evaluates the performance of five accrual-based models. They found that all models are well specified but that the modified Jones model (Jones, 1991) was the most powerful one. A well specified model means that there are few type I errors. A type I error arises when the model concludes that earnings are managed, when in fact they are not managed. A model is powerful when there are few type II errors. A type II error arises when the model concludes that earnings are not managed, when in fact they are managed.

**Firm age (AGE):** As time passes, firms discover what they are good at and learn how to do things better as they specialize more and new techniques are found to standardize, coordinate, and speed up their production processes, as well as to minimize costs and improve quality (Arrow 1962, Ericson and Pakes 1995).

Based on prior research, Firms that have been in the market for long times tend to have low level of earnings management than beginners as they are well known companies, that have a great value in the market and they have a reputation to protect, also they are aware of the rules and codes that govern their practices. Moreover, Old firms might have improved their financial reporting practices over time (Alsaed 2006) and secondly they try to enhance their reputation. The date of incorporation is retrieved from Orbis. Older firms are more likely to be in more mature industries (Zhang, 2006). Wu and Huang (2011) argue that there is a negative relation between firm age and earnings management. Because older firms are generally more stable and operate in more mature industries, I expect a negative relation between AGE and discretionary accruals. Therefore, we formally state the hypothesis as follows:

H1: AGE has a negative relation (-) to the earnings quality.

**Audit quality (AQ):** High quality audit is more likely to detect and report errors and irregularities. Thus, it is an effective barrier to earnings manipulations (DeAngelo 1981). Auditing reduces asymmetries between managers and shareholders by allowing outsiders to verify the validity of financial statements and by that it is a valuable monitoring method used by firms to reduce agency costs (Watts and Zimmerman 1983). Auditors provide assurance of the accounting information supplied to outside investors. The literature has consistently provided evidence that Big 4 auditors are quality differentiated from non-Big 4 auditors in the U.S. and around the world.

The big four auditing firms have a very huge incentive to maintain a high audit quality due to the following reasons, the first one is that they have large number of clients, in addition, better resources employed like the technology, training programs and experience, finally the last reason is having a reputation that might be lost if they didn't report a misstatement or a manipulation (Rusmin, 2010, and Chung et al 2005). Previous literature found that Big 4 auditors are associated with better audit quality compared to non- Big 4 auditors. Francis and Krishnan (1999) found that Big 6 audit firms report more conservatively than non-Big 6 audit firms. Basu et al. (2000) found that Big 8 audit firms have a greater exposure to legal liability and litigation costs, so they report more conservatively than non-Big 8 audit firms. Firms audited with auditors other than the big four report significantly greater discretionary accruals as stated by (Lenard and Yu 2012) confirming this inverse relation (Bartov et al 2000) suggest that higher quality auditors tend to report any error and have no willingness to accept any manipulations. The study by (Yasar, 2013) finds that the audit quality doesn't have an impact on discretionary accruals so there is no difference in audit quality between Big Four and non-Big four audit firms in constraining the practice of earnings management (Piot and Janin 2007) agreed to this finding. Following prior studies (Teoh and Wong, 1993; Becker et al., 1998; Choi and Wong, 2007), we use an indicator variable for Big 4/non-Big 4 membership to proxy for auditor quality. Therefore, a negative relation between AUD and discretionary accruals is expected. Consequently, this paper proposes the following hypotheses:

H2: AUD has a negative relation (-) to the earnings quality.

**Firm size (SIZE):** The size of a firm varies in many ways and it's essential to consider how the size affects the quality of reported information. It is argued by (Meek et al 2007) that based on the information asymmetry theory, large firms have lower information asymmetry as they have strong governance and control so this leads to the reduction of the earnings management practice. While based on the agency theory, large sized firms witness greater agency costs and this means more opportunistic practices (Jensen and Meckling 1976). Several reasons exist to prove a negative relation between firm size and earnings management as explained by (Ahmad et al 2014 and Kim et al 2003), Large-sized firms may have stronger internal control system and may have more competent internal auditors as

compared to small-sized firms therefore; an effective internal control system helps in publishing reliable financial information to the public, so this will likely reduce the ability of the management to manipulate earnings. Also large firms are usually audited by one of the big four auditing firms and this helps prevent earnings management due to the efficient and effective audit performed. A third reason is the reputation cost, in large firms the reputation cost is higher than that in the small firms as large firms have better appreciation of market environment, better control over their operations and better understanding of their businesses relative to small-sized firms, therefore this might prevent large firms from engaging in earnings management practices. Dechow and Dichev (2002) found that large firms have more stable and predictable operations and therefore fewer and smaller estimation errors. Therefore the control variable SIZE is added to the model. Author expect that the size of a firm is positively related to the level of discretionary accruals.

H3: Firm size has a positive relation (+) to earnings quality.

**Net cash from operating activities (OCF):** The control variable OCF is included because firms with higher cash flow from operations are more likely to be better performers (Frankel et al., 2002). Operating cash flow (OCF) is cash generated from normal operations of a business. Analysts consider operating cash flow important because it provides them insight into the health of core business or operations of a company. As an essential part of the Cash Flow Statement, the cash flows of operating activities, investing activities, and financing activities are segregated, so analysts can get a clear picture of the cash flows of a company's all activities. Sloan (1996) and Dechow (1994) concluded that on average accruals and cash flows are negatively correlated. Consistent with previous literature, I expect that the variable CFO is negatively correlated with discretionary accruals:

H4: Net cash from operating activities has a negative relation (-) to the earnings quality.

**Audit opinion (OPINION):** Bartov et al. (2001), in a study examining the ability of various accruals models to detect earnings management, find that a significant positive link exists between the absolute value of discretionary accruals and the likelihood of receiving a qualified opinion. However, this relationship is significant for only two of the models tested – the cross-sectional Jones (1991) model and the cross-sectional modified Jones (Dechow, Sloan, & Sweeney, 1995) model. Sengupta and Shen (2007) re-examine this issue and indicate that the likelihood of receiving a going-concern audit opinion is higher when the quality of accruals for a firm is low. Arnedo, Lizarraga, and Sanchez (2008) test this relationship in a Spanish context for a sample of private pre-bankrupt firms. They separate the qualified opinions into two groups – qualified based on going-concern issues and qualified for other reasons. Their evidence, consistent with Butler et al. (2004), reveals a negative association, which stems from reports containing uncertainty about the likelihood of a firm continuing as a going-concern. A positive relationship is found, however, when the reasons for the qualification are other than the going-concern. Unlike Butler et al. (2004), they claim that auditor reporting is a positive response to earnings management and that the negative relationship in going-concern cases is a consequence of auditor conservatism rather than a result of the distressed status of the firm and its liquidity tactics for survival. The inconclusive evidence of prior studies raises a question regarding the association between earnings management and the issuance of a qualified audit opinion in Greece. In contrast to the US, where most audit reports are qualified based on the going-concern uncertainty, Greek qualified audit reports are frequently issued for reasons other than going-concern. This implies that auditors have the opportunity to convey different warning signals to users of the financial statements. As Lam and Mensah (2006) state, it is an empirical question of whether auditors, when granted a greater degree of flexibility by both a more limited litigation-risk environment and the option to issue a wider range of audit reports, attempt to convey more information to the public. In an effort to examine this relationship in detail, we divide qualified opinions into two categories – qualified opinion and unqualified opinion.

H4: Audit opinion has a negative relation (-) to the earnings quality.

### 3. Data and Variables

#### 3.1. Sample Description and Panel data

Secondary data type is used as the data gathered to measure the dependent and independent variables is from the financial statements. This study is considering a panel data type and this will require conducting the fixed/random effect generalized least square (GLS) regression using the Stata program. In this study, the data set includes a 284 companies on Vietnam stock markets (HNX and HOSE) in the period from 2012 to 2015. For some enterprises, collected data consists of annual financial statement reports. Following the above sample selection process, a total of 1136 observations are collected.

This section proposes the use of panel data instead of the cross sectional assumption and this means that the observations contain both time series and cross sectional units. As defined by (Brooks 2008), "Panel data will embody information across both time and space". Panel analysis begins with determining the type of regression needed for the study and the panel data models are either fixed effects or random effects models. The panel data methodology has an important advantage which is the assumption that firms are heterogeneous, and this is an advantage over studies that use time series or cross sectional data. Other advantages for panel data are added like being very informative and having more variability and less collinearity among the variables, therefore using panel data is better for having unbiased

and more reliable results, this is proposed in a book by (Baltagi, 2011).

In models with fixed effects, as explained by (Pintea et al, 2014), the error component can be correlated with regressors; research hypothesis states no correlation between regressors and random error component. While the random effects model assumes that the error component is a totally random error, and the assumption is that the error does not correlate with regressors (Baum, 2001; Baltagi, 2008). The rationale behind random effects model is that, unlike the fixed effects model, the variation across entities is assumed to be random and uncorrelated with the predictor or independent variables included in the model, so the entity's error term is not correlated with the predictors which allows for time-invariant variables to play a role as explanatory variables. (Kohler and Kreuter, 2012; Greene, 2008)

### 3.2. Variables

Earnings management is a proxy to measure earnings quality (Chen et al., 2008; Davis et al., 2007, Johnson et al., 2002, Myers et al., 2003). Earnings management (DA) is the use of accounting techniques to produce financial reports that present an overly positive view of a company's business activities and financial position. Many accounting rules and principles require company management to make judgments. Earnings management take advantage of how accounting rules are applied and creates financial statements that inflate earnings, revenue or total assets. The majority of recent earnings management literature relies primarily on discretionary accruals as a proxy for earnings management and so this study will use the discretionary accruals as a proxy for earnings management. Most researchers prefer to use the cash flow statement approach as it is more useful than the balance sheet approach (Shah et al., 2009, Soliman and Ragab 2014).

This study will use the cash flow statement approach to calculate the total accruals, so based on that approach the total accruals can be calculated as follows:  $TAt = NIt - CFOt$

Where: TAt: total accruals in year t, NIt: net income in year t, CFOt: cash flows from operating activities in year t.

Total accruals are not the proxy for earnings management; on the contrary, earnings management is the part of the accruals that managers can have control on and are able to practice manipulations. According to this, the total accruals are divided into two parts which are the discretionary accruals and the non-discretionary accruals. So to calculate the discretionary accruals, non-discretionary accruals are subtracted from total accruals (Shah and Butt 2009). Where: TA: total accruals, DA: discretionary accruals, NDA: non-discretionary accruals

Consequently, based on the modified Jones model 1995, that this study uses, the equation to be used in calculating the NDA is as follows: (Uwuigbe et al 2015 and Shah et al 2009)  $NDA_t = \beta_1j [1/At-1] + \beta_2j [\Delta REV_t - \Delta ART/At-1] + \beta_3j [PPE_t/At-1]$

Where: NDA<sub>t</sub> : Non discretionary accruals for firm j in year t, At-1: Total assets for firm j in year t-1,  $\Delta REV_t$ : Change in the revenues (sales) for firm j in year t less revenue in year t-1,  $\Delta ART$  : Change in accounts receivables for firm j in year t less receivable in year t-1, PPE<sub>t</sub> : Gross properties, plants and equipments for firm j in year t,  $\beta_1j, \beta_2j, \beta_3j$  are firm specific parameters In order to find the firm specific parameters to be used in the NDA equation, a regression equation is used to find those parameters and this equation is as follows: (Ahmad et al., 2014; Salleh and Haat, 2014; Uwuigbe et al, 2015)

$$TAC_t/At-1 = \beta_1j [1/At-1] + \beta_2j [(\Delta REV_t - \Delta ART)/ At-1] + \beta_3j [PPE_t/ At-1] + \epsilon_t$$

After calculating the total accruals using the cash flow statement approach and calculating the non-discretionary accruals through the equation of the modified Jones model (1995), the discretionary accruals can then be calculated using the following equation:

$$DA_{jt} = TAC_{jt} - NDA_{jt}$$

In this study, on the basis of previous studies, three independent variables are used in this research: AGE, AUD, AGEAUD and three control variables are SIZE, OPINION, OCF. As far as independent and control variables are concerned, we have selected several proxies that appear in the empirical literature.

AGE = the number of years since the firm's listed in the stock market.

AQ= A dummy variable equal to 1 if the company is audited by a Big 4 audit firm, and 0 otherwise

AGEAQ = interact variables, This was done in order to examine how firm age and the audit quality interact and what is their impact on earnings management.

SIZE = The natural logarithm of the book value of total assets at year-end

OCF = Net cash flows from operations in statement of cash flows

OPINION = type of audit opinion received by the client: 1 if the unqualified opinion in auditor's report, 0 otherwise.

### 4. Research Methodologies

To test for the hypotheses, this research utilizes the following regression model to examine and test for the impact of multiple independent variables which are the firm age, audit quality on the dependent variable which is the earnings management practice in the 284 most active firms in the Vietnam stock exchange.

Based on previous researches, these regression model can be specified as follows:

Research model:

$$DA_{i,t} = \alpha + \beta_1 AGE_{i,t} + \beta_2 AQ_{i,t} + \beta_3 AGEAQ_{i,t} + \beta_4 SIZE_{i,t} + \beta_5 OCF_{i,t} + \beta_6 OPINION_{i,t} + \epsilon_{i,t}$$

**Table 1: Proxies, Expected relationship**

No.	Independent variables		Hypothesis
	Name	Sign	
1	Firm age	AGE	(-)
2	Audit quality	AQ	(-)
3	Firm age * Audit quality	AGEAQ	(+)
4	Firm size	SIZE	(+)
5	Net cash from operating activities	OCF	(-)
6	Audit opinion	OPINION	(-)

Source: Author's summary

## 5. Results

**Table 2: Descriptive statistics of sample variables**

Variable	Obs	Mean	Std. Dev	Min	Max
DA	1136	8191.75	853880.6	-2.49*10 <sup>7</sup>	5490033
AGE	1136	6.257042	2.2396	2	15
AGEAQ	1136	1.897007	3.104203	0	15
SIZE	1136	13.45698	1.531877	9.514879	18.79565
OCF	1136	153919.1	1068963	-3051364	2.79*10 <sup>7</sup>

AQ	Freq.	Percent
0	788	69.37 %
1	348	30.63%

OPINION	Freq.	Percent
0	787	69.28%
1	349	30.72%

Source: Descriptive statistics with STATA.

The descriptive statistics are presented in table 2. The mean of the absolute discretionary accruals is 8191.75 (comparable with descriptive statistics from Chi et al., 2005; Chen et al., 2008; Menon & Williams, 2004; Myers et al., 2003). The average age of a sample firm is approximately 6.5 years and the variable has a large standard deviation. This indicates that there are very old and very young firms in the sample. The variable AQ indicates whether a firm is audited by a Big 4 or by a non-Big 4. Most firms in this sample, more than 65%, are audited by a Big 4 firm. The averages of SIZE and OCF are respectively 13.456; 153919.1.

**Table 3: Pearson correlation coefficient matrix**

	DA	AGE	AQ	AGEAQ	SIZE	OCF	OPINION
DA	1.0000						
AGE	-0.0068	1.0000					
AQ	-0.0110	-0.0192	1.0000				
AGEAQ	-0.0208	0.1953	0.9200	1.0000			
SIZE	-0.0336	0.0876	0.5210	0.4989	1.0000		
OCF	-0.8066	0.0595	0.1663	0.1982	0.2940	1.0000	

<b>OPINION</b>	-0.0088	0.0187	0.0912	0.0861	-0.0102	-0.0508	1.0000
----------------	---------	--------	--------	--------	---------	---------	--------

Source: Pearson correlation with STATA.

The Pearson's correlation matrix is used and it shows the degree of correlation between the independent variables and based on (Soliman 2013, cited in Bryman and Cramer 1997), the Pearson's correlation between independent variables should not exceed 0.8 to prove that there is no multicollinearity problem among the variables. To test the correlation between the variables the Pearson correlation coefficient was used. With this test has been measured how variables move from each other. The correlations between the variables in table 3, gives a first indication about the sign and the influence of the variables in determining leverage. The correlation of -0.0068 for AGE and DA indicates that there is a negative relation between the variables. The same applies for the AQ with a correlation of -0.0110. The SIZE, OCF,OPINION are negative correlated with a correlation of -0.0336, -0.8066 and -0.0088.

**Table 4: The regression results of model**

Independent variables	FEM		REM	
	Coef.	P>  t	Coef.	P>  t
AGE	*** 11596.68	0.008	-600.1909	0.866
AQ	***- 373682.6	0.004	*** -274560.5	0.007
AGEAQ	*** 51953.95	0.005	*** 50581.49	0.004
SIZE	* 43974.52	0.098	*** 147774.6	0.000
OCF	***-.9923541	0.000	***-.899564	0.000
OPINION	-11627.14	0.451	** -50557.87	0.012
CONS	-483902.9	0.164	*** -1834506	0.000
Number of obs	1136		1136	
Number of groups	284		284	
R-squared				
Within	0.9024		0.9007	
between	0.5199		0.5599	
overall	0.6698		0.7019	
Wald test	0.078 ***			
Wooldridge test	0.1943 ***			
P_Value > $\chi^2$ = 0.0000 ***				

Source: Regression with STATA.

**Table 5: Hausman test**

Independent variables	FEM	REM	Diff.
AGE	11596.68	-600.1909	12196.87
AQ	-373682.6	-274560.5	-99122.15
AGEAQ	51953.95	50581.49	1372.46
SIZE	43974.52	147774.6	-103800.1
OCF	-.9923541	-.899564	-.0927901
OPINION	-11627.14	-50557.87	38930.73

Chi2 = 17.22; Prob> chi2 = 0.0018

Source: Regression with STATA.

Hausman test is carried out for the sample of 284 firms for the period from 2012 to 2015, using the discretionary accruals as a dependent variable, the results show that P-value is 0.0018, smaller than 5% of significant level, so FE estimation method is more suitable than RE method. Therefore, we will use the estimated results based on FE for analysis.

The estimated results based on FE show that four elements – AGE, AQ, AGEAQ, OCF, SIZE affect on the earnings quality. AGE, AQ, AGEAQ, OCF affect at significant level of 1%, and SIZE affect at significant level of 10%. AGE, AGEAQ, SIZE variables of the research have positive relation to the earnings quality except AQ, OCF variable.

The model is found to be highly significant as the significance level is shown to be (0.0000) and the adjusted R Square is equal to (0.5199) which means that 51.99% variation in the dependent variable (earnings quality) is explained by the independent variables this is similar to the previous results. The rest of the independent variables show an significant relationship with the dependent variable as their values are smaller than 0.05, as shown in table 4, which leads to the rejection of their hypotheses and these results regarding the relation between the firm size and audit quality are similar to the findings of (Al saeed ,2006; and Chung et al, 2005). The sign is negative and this indicates that earnings quality increases with firm age, OCF, which is consistent with the literature (Chen, 2008; Sloan, 1996; Dechow, 1994).

The firm age variables are statistically significant in research models and have a positive impact on earnings quality. Finding suggest that firms with the long time listed years typically use accounting estimate through an optional accounting behaviors are used to manipulate earnings from financial reporting. The audit quality variable is negatively significant, which indicates that clients which are audited by a big 4 firm, have lower earnings quality. This is consistent with previous research (Basu et al., 2000). Our findings provide further empirical evidence on the significant influence of firm age, audit quality on the earnings quality.

## 6. Conclusion

This paper examines the impact of firm age and audit quality on earnings quality in the 284 most active firms listed in the Vietnam stock exchange from the year 2012-2015. The study extends research on the quality of financial reporting and its importance. The findings are of great importance for future researchers who aim to conduct further studies in this topic in the Vietnam market and generally speaking the finding are important for investors in developing countries as well as other stakeholders as they depend on the reported financial information to take investment and other decisions.

Findings from the tests conducted indicate that only 51.99% change in the firm's earnings quality is explained by firm age and audit quality which is a high percentage, thus very close and similar to other studies analyzing the same relation. Based on the results of this study, the firms' size has a significant positive relation with earnings quality which gives an indicator for the firms to control the level of size as to avoid. The model with dependent variable earnings quality provided a negative association between discretionary accruals and cash flow from operations. This research contributes to the existing literature by adding evidence in determining the earnings quality. The results contribute due to the most recent data that has been used in comparison with other studies on Vietnam firms.

## 7. Limitations and suggestions for future research

We acknowledge several limitations in our empirical analysis. Our empirical findings are not necessarily applicable to financial, investment firms. Second, due to the short sample period, we are unable to examine whether the appointment of firm age and audit quality would improve earnings quality. Third, we recognize that the applied accruals models may not provide perfect estimates of the extent of earnings quality. Finally, it should be noted that our findings may suffer from a self-selection bias.

Future research work should be done in other bank and financial corporations. This will enhance the scope of the findings and level of generalization. The future research could measure quality reporting using other indices of reporting quality and tracking the specific fixed effect of top management team over time, better understandings of firm characteristics role is crucial for financial quality reporting.

## References

- [1] Abdul Rahman, R., & Haneem Mohamed Ali, F. (2006). Board, audit committee, culture and earnings management: Malaysian evidence. *Managerial Auditing Journal*, 21(7), 783-804.
- [2] Ahmad, M., Anjum, T., & Azeem, M. (2014). Investigating the impact of corporate governance on earning management in the presence of firm size; evidence from Pakistan. *International Interdisciplinary Research Journal*, 3(2), 84-90.
- [3] Akhtaruddin, M. (2005). Corporate mandatory disclosure practices in Bangladesh. *The International Journal of*

Accounting, 40(4), 399-422.

- [4] Alsaeed, K. (2006). The association between firm-specific characteristics and disclosure: The case of Saudi Arabia. *Managerial Auditing Journal*, 21(5), 476-496.
- [5] Arrow, K. (1962). Economic implication of learning by doing. *Review of economic studies*, 29(3), 155-173.
- [6] Baiman, S. 1982. Agency research in managerial accounting: A survey. *Journal of Accounting Literature* 1: 154-178.
- [7] Ball, R., Shivakumar., L. (2004). Earnings quality in U.K. private firms: Comparative loss recognition timeliness. LBS Accounting Subject Area Working Paper No. ACCT025, 1-63.
- [8] Barth, M. E., Cram, D.P., Nelson, K.K. (2001). Accruals and the Prediction of Future Cash Flows. *The Accounting Review*, 76(1), 27-58.
- [9] Basu, S., Hwang, L., Jan, C. (2000). Differences in conservatism between Big Eight and non-Big Eight auditors. Working paper, City University of New York and California State University.
- [10] Becker, C.L., DeFond, M.L., Jiambalvo, J., Subramanyam, K.R. (1998). The effect of audit quality on earnings management. *Contemporary Accounting Research*, 15 (1), 4–24.
- [11] Bellovary, J.L., Giacomino, D.E., Akers, M.D. (2005). Earnings Quality: It's Time to Measure and Report. *The CPA Journal*.
- [12] Beneish, M. D. (2001). Earnings management: A perspective. *Managerial Finance*, 27(12), 3-17.
- [13] Butler, M., Leone, A.J., Willenborg, M. (2004). An empirical analysis of auditor reporting and its association with abnormal accruals. *Journal of Accounting Review*, 81(3), 653-676.
- [14] Carcello, J.V., Nagy, A.L. (2004). Audit Firm Tenure and Fraudulent Financial Reporting. *Auditing: A Journal of Practice and Theory*, 23(2), 55-69.
- [15] Chen, C-Y., Lin, C-J., Lin, Y-C. (2008). Audit Partner Tenure, Audit Firm Tenure, and Discretionary Accruals: Does Long Auditor Tenure Impair Earnings Quality? *Contemporary accounting research*, 25(2 ), 415-446.
- [16] Choi, J. H., & Wong, T. J. (2007). Auditors' governance functions and legal environments: An international investigation. *Contemporary Accounting Research*, 24(1), 13-46.
- [17] Christie, A. A., & Zimmerman, J. L. (1994). Efficient and opportunistic choices of accounting procedures: Corporate control contests. *Accounting Review*, 539-566.
- [18] Chung, R., Firth, M., & Kim, J. B. (2005). Earnings management, surplus free cash flow, and external monitoring. *Journal of business research*, 58(6), 766-776.
- [19] Craswell, A. T., Francis, J. R., & Taylor, S. L. (1995). Auditor brand name reputations and industry specializations. *Journal of accounting and economics*, 20(3), 297-322.
- [20] Davis, L., Soo, B., Trompeter, G. (2007). Auditor tenure and the ability to meet or beat earnings forecasts. Working paper. Michigan Tech University.
- [21] DeAngelo, L. (1981). Auditor size and audit quality. *Journal of Accounting and Economics*, 3, 189–199.
- [22] Dechow, M.P., Sloan, R.G., Sweeney, A.P. (1995). Detecting Earnings Management. *The Accounting Review*, 70(2), 193-225.
- [23] Dechow, P. M., & Dichev, I. D. (2002). The quality of accruals and earnings: The role of accrual estimation errors. *The accounting review*, 77(s-1), 35-59.
- [24] Dechow, P., Ge, W., & Schrand, C. (2010). Understanding earnings quality: A review of the proxies, their determinants and their consequences. *Journal of accounting and economics*, 50(2), 344-401.
- [25] Eisenhardt, K. M. 1989. Agency theory: An assessment and review. *Academy of Management Review* 14: 57-74.
- [26] Ericson, R., & Pakes, A. (1995). Markov-perfect industry dynamics: A framework for empirical work. *The Review of Economic Studies*, 62(1), 53-82.
- [27] Francis, J. R., & Wang, D. (2008). The joint effect of investor protection and Big 4 audits on earnings quality around the world. *Contemporary accounting research*, 25(1), 157-191.
- [28] Ghosh, A., Moon, D. (2005). Auditor Tenure and Perceptions of Audit Quality. *The Accounting Review*, 80(2), 585-612.
- [29] Healy, P. M., & Wahlen, J. M. (1999). A review of the earnings management literature and its implications for standard setting. *Accounting horizons*, 13(4), 365-383.
- [30] Healy, P.M. (1985). The effect of bonus schemes on accounting decisions. *Journal of Accounting and Economics*, 7(4), 85-107.
- [31] Holthausen, R. W. (1990). Accounting method choice: Opportunistic behavior, efficient contracting, and information perspectives. *Journal of accounting and economics*, 12(1-3), 207-218.
- [32] Jensen, M. C., & Meckling, W. H. (1976). Theory of the firm: Managerial behavior, agency costs and ownership structure. *Journal of financial economics*, 3(4), 305-360.
- [33] Johnson, V. E., Khurana, I. K., & Reynolds, J. K. (2002). Audit-firm tenure and the quality of financial reports. *Contemporary accounting research*, 19(4), 637-660.
- [34] Kanagaretnam, K., Lim, C. Y., & Lobo, G. J. (2010). Auditor reputation and earnings management: International evidence from the banking industry. *Journal of Banking & Finance*, 34(10), 2318-2327.
- [35] Lenard, M. J., & Yu, B. (2012). Do earnings management and audit quality influence over-investment by Chinese



- companies?. *International Journal of Economics and Finance*, 4(2), 21-30.
- [36] Maletta, M., & Wright, A. (1996). Audit evidence planning: An examination of industry error characteristics. *Auditing*, 15(1), 71-86.
- [37] Mansi, S. A., Maxwell, W. F., & Miller, D. P. (2004). Does auditor quality and tenure matter to investors? Evidence from the bond market. *Journal of Accounting Research*, 42(4), 755-793.
- [38] Myers, J. N., Myers, L. A., & Omer, T. C. (2003). Exploring the term of the auditor-client relationship and the quality of earnings: A case for mandatory auditor rotation?. *The Accounting Review*, 78(3), 779-799.
- [39] Piot, C., & Janin, R. (2007). External auditors, audit committees and earnings management in France. *European accounting review*, 16(2), 429-454.
- [40] Reynolds, J. K., & Francis, J. R. (2000). Does size matter? The influence of large clients on office-level auditor reporting decisions. *Journal of accounting and economics*, 30(3), 375-400.
- [41] Rusmin, R. (2010). Auditor quality and earnings management: Singaporean evidence. *Managerial Auditing Journal*, 25(7), 618-638.
- [42] Simunic, D., Stein, M.. (1987). Production Differentiation in Auditing: A Study of Auditor Choice in the Market for New Issues. *Canadian Certified General Accountants' Research Foundation*.
- [43] Teoh, S. H., & Wong, T. J. (1993). Perceived auditor quality and the earnings response coefficient. *Accounting Review*, 346-366.
- [44] Watts, R & Zimmerman, J. (1978). Towards a positive theory of the determination of accounting standards. *The accounting review*, 53 (1), 12-134.
- [45] Watts, R., Zimmerman, J. (1986). *Positive Accounting Theory*. Englewood Cliffs, NJ: Prentice Hall Inc.
- [46] Watts, R., Zimmerman, J., (1983). Agency problems, auditing, and the theory of the firm: Some evidence. *Journal of Law and Economics*, 26, 613-633.
- [47] Waweru, N. M.. & Riro, G. K. (2013). Corporate governance, firm characteristics and earnings management in an emerging economy. *Journal of Applied Management Accounting Research*, 11(1), 43-64.
- [48] Yasar, A. (2013). Big Four Auditors' Audit Quality and Earnings Management: Evidence from Turkish Stock Market. *International journal of business and social science*, 4(17), 153-163.

# Personalization in The Age of Internet of Things: Implications for Vietnamese Enterprises

Dung Phuong Hoang \*

Faculty of International Business, Vietnam Banking Academy, 12 Chua Boc Street, Hanoi city, 10000, Vietnam

## ABSTRACT

As an important dimension of the Fourth Industrial Revolution, the Internet of Things (IoT), a network of billions of intelligent connected “things” which can communicate to Internet and to each other, has widely expanded and changed the marketing environment. Accordingly, marketing strategies have been changed toward more “personalization”. In which the evolution of The IoT, on one side, increases the role of personalization in marketing as a core strategy in finding, winning, growing and maintaining customers as well as building sustainable competitive advantages, on the other side; facilitates more effective and comprehensive personalization due to the development and increasing use of Big Data and predictive analytics. Although with the support of IoT technologies, personalization enables customers to have better offerings at lower costs while marketers can gain more customer satisfaction, loyalty and response rates, some costs related to privacy risks and spam risks to customers as well as risks of irritating customers and required investment in technology, data collection and analytics are also increasing. Based on the context of IoT in Vietnam, the study will propose some managerial implications for Vietnamese enterprises in taking advantages of IoT in its infant stage for efficient personalization and stronger competitiveness.

**Keywords:** Internet of Things; Personalization; Marketing; Fourth Industrial Revolution.

## 1. Introduction

Nowadays, broadband Internet is getting widely available while the cost of Internet connection is decreasing. In addition, the number of devices which are made with Wi-Fi capabilities and sensors built into them has been increasing rapidly. Especially, smartphone penetration rates in both developed and developing countries have grown at sky-rocketing speed due to reduction in technology costs. All of these factors are creating a storming evolution of the Internet of Thing (IoT), a network of everyday objects digitally interconnected to the internet and to each other (du Pre Gauntt and Stahl, 2016). According to Anthem Marketing Solution (2016), since 2008, the number of connected devices has exceeded the total world population. By 2020, it is estimated that there will be around 50 billion connected devices worldwide or on average, there will be about 6.5 connected devices per person. The global research on 499 leading CMOs by The Economist Intelligence Unit (EIU) in 2016 has revealed that personalization was emphasized repeatedly in the survey results and interviews as a driving force for marketing success by 2020 upon the development and application of Big Data and predictive analytics enabled by IoT (du Pre Gauntt and Stahl, 2016). However, there has been no studies examining in-depth how the evolution of IoT transforms the framework of personalization in terms of what to personalize, personalize to whom, who does personalization as well as the execution of personalization and its values to both customers and marketers.

In Vietnam, IoT technologies are at their infant phases in which some preliminary applications have been already developed in telecommunications, banking, home architecture, transportation, automotive industries and projected public services. The emerging and inevitable IoT trend has gradually changed marketing environment, especially customers’ expectations and the way companies compete to each other. Vietnamese enterprises should in a position to take advantage of the IoT so as to create their own competitive advantages.

The study will firstly review the literature on the IoT and personalization and analyse how the IoT changes the role and execution of personalization so as to propose a conceptual framework of personalization within an IoT. In

\* Corresponding author. Tel.: +84 913 393 860.  
E-mail address: dunghp@hvn.edu.vn

addition, based on the IoT context in Vietnam, the study will point out opportunities for Vietnamese enterprises in adopting personalization approach as well as propose some managerial implications for Vietnamese marketers in designing and implementing personalization strategies in the age of IoT.

## 2. The concept of Internet of Things

Due to the growing importance and significant impacts of the IoT across various industries, business management fields and social life, the IoT has become a topic of many conversations and researches. However, there are still a lot of confusion and complexities around the term “Internet of things”. Specifically, the literature reveals many different definitions of the IoT. The concept of IoT was first proposed by Kevin Ashton in 1999 in which the IoT was referred as objects which are uniquely identifiable interoperable connected upon the use of radio frequency identification technology (RFID) (Ashton, 2009). In other words, the use of RFID technology has initiated by the emergence of IoT starting with some applications in pharmaceutical production, logistics and retail (Fielding and Taylor, 2002; Guinard et al. 2009). The application of wirelessly sensory technologies, from the birth of wireless sensor networks (WSNs), intelligent sensing, Web2.0, low energy wireless communications, cloud computing since 2005 to the launch of smart things with mobile computing and connected devices since 2012, has remarkably enhanced the sensory capabilities of devices and transformed the concept of the IoT upon different perspectives (Jiang et al., 2014 ; Li et al., 2013; Ren et al., 2012; Tao et al., 2014 ; Wang et al., 2014). According to IERC (2013); Kirtsis (2011) and Li et al. (2012), IoT represents “dynamic global network infrastructure with self-configuring capabilities based on standards and interoperable communication protocols” in which physical and virtual ‘things ’ have their own identities and attributes with capabilities of using intelligent interfaces to create an integrated information network.

The differences in defining the IoT have been explained by Greene (2015) that "there is no hard and fast definition of the Internet of Things, in part, because it is so new and continues to evolve. Even five or ten years from now, we will likely be calling the IoT something different". Overall, the IoT definition proposed by International Telecommunication Union (2012) may be the most general and comprehensive in which IoT is defined as “a global infrastructure for the information society, enabling advanced services by interconnecting (physical and virtual) things based on existing and evolving interoperable information and communication technologies” since it demonstrates the core features of IoT (i.e. digital interconnection of things) while admitting that IoT technologies are still evolving.

According to the road map of the IoT’s evolution summarized by Li et al. (2015), advanced sensor fusion, faster wireless connectivity and predictive analytics are expected to dominate the IoT technological base by 2017. Thereby, a new array of definitions about the IoT may be coined in the coming time.

**Fig. 1. Evolution of IoT (Li et al., 2015)**

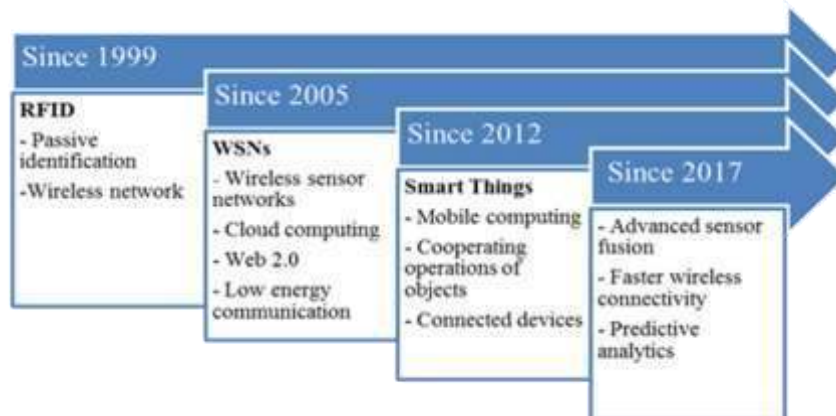

Due to the rapid evolution and application of IoT, the numbers of objects and devices which can interact within an IoT have increased rapidly ranging from devices for customer usage such as smartphones, headphones, wearable devices, household appliances, etc. to devices applicable for various business sectors such as industrials, retailing, restaurant, home services, etc. The widespread of IoT has changed the way people work and live as well as their expectation, therefore, transformed customer behaviour while opening up endless opportunities for innovation, creativity and data-driven base in marketing. In which, there is a factor which play an increasingly important role in managing customer satisfaction and loyalty since the emergence and evolution of the IoT, that is personalization.

The following parts will discuss the concept and role of personalization as well as how the IoT facilitates and makes personalization a crucial competitive edge of every firms.

### 3. The concept of personalization

Personalization is not a new concept in marketing; in fact, the first personalization practice has been adopted to direct marketing letters since the 1870s (Ross, 1992). The term was first conceptualized by Peppers and Rogers (1993) as an integral part of one-to-one marketing which helps resolve the information overload and the “one size fit all” issue. Due to the development of advanced technology, especially in communication, information processing and production, many aspects of marketing can be personalized that makes personalization have many different meanings ranging from customizing the products or services to tailoring visual layout and content of promotional messages as well as website interactions, to name a few examples. Consequently, the literature reveals no common conceptual framework of personalization, instead, personalization is defined differently based on what to personalization, who does personalization and to whom to personalize (Fan and Poole, 2006) as well as how to personalize and goals of personalization. Table 1 below shows these dimensions extracted from various definitions of personalization.

**Table 1. Definitions of personalization (developed for this study)**

<b>Author</b>	<b>Definition</b>
Adomavicius and Tuzhilin (2006)	“Personalization tailors certain offerings (such as content, services, product recommendations, communications and e-commerce interactions, which is in fact a facet of comparison-shopping agents) by providers (such as e-commerce websites) to consumers (such as customers and visitors) based on knowledge about them, with certain goal(s) in minds”
Coner (2003)	“Personalization is performed by the company and is based on a match of categorized content to profiled users”
Desai (2016)	“Personalization is the process of providing customized information, presentation and structure of the website based on the need of the user”
Doug Riecken (2000)	“Personalization is about building customer loyalty by building a meaningful one-to-one relationship; by understanding the needs of each individual and helping satisfy a goal that efficiently and knowledgeably addresses each individual's need in a given context”
Fan and Poole (2006)	“A process that changes the functionality, interface, information access and content or distinctiveness of a system to increase its personal relevance to an individual or a category of individual”
Hanson (2000)	“A specialized form of product differentiation, in which a solution is tailored for a specific individual”
Imhoff et al. (2001)	“Personalization is the ability of a company to recognize and treat its customers as individuals through personal messaging, targeted banner ads, special offers on bills, or other personal transactions”
Murthi and Sarkar (2003)	The point when a firm decides which marketing mix is most suitable for an individual customer based on previous collected customer data
Peppers et al. (1999)	“Customizing some feature of a product or service so that the customer enjoys more convenience, lower cost, or some other benefit”
Roberts (2003)	“The process of preparing an individualized communication for a specific person based on stated or implied preferences”
Wind and Rangaswamy (2001)	“Personalization can be initiated by the customer (e.g. customizing the look and contents of a web page) or by the firm (e.g. individualized offering, greeting customer by name etc.)”

Despite various definitions of personalization, the literature review reveals that personalization has become more technology-based and data-driven so that marketing mix activities and provider-customer interaction, especially e-commerce interaction are widely tailor-made to suit customers’ needs. As a result, customers or customer groups are treated individually for their personalized purchasing experience.

Upon reviewing researches and definitions of personalization, it is found that the evolution of IoT has supported the changes in what to personalize, who does the personalization, personalize to whom, the execution of personalization as well as benefits and costs related to personalization. The following part will further discuss how the IoT has transformed the conceptual framework of personalization.

### 4. Personalization in the IoT age

Due to the rapid growing number of connected devices in the world, the IoT has been moving offline objects and experiences online so that customers and suppliers increasingly interact with each other through “things” (i.e. laptops, tablets, smartphones) on virtual environment (i.e. website) rather than face-to-face communication. Accordingly, the focus of what to personalize has expanded from customizing some features of a product or service so that customers’

needs or goals are efficiently satisfied (Peppers et al., 1999; Hanson, 2000; Doug Riecken, 2000) to “personal messaging, targeted banner ads, special offers on bills, or other personal transactions” (Imhoff et al., 2001) then website experience or e-commerce interactions in which information access, interface, presentation and website structured are customized distinctly according to users’ personal needs (Adomavicius and Tuzhilin, 2005; Desai, 2016; Fan and Poole, 2006).

Obviously, personalization practices require marketers to obtain adequate knowledge about customers in advance. Without Internet and connected devices, marketers can only acquire customer data by explicitly asking them through dialogues or survey or recording their demographic factors and previous purchasing behaviour which have already happened. As a result, marketers can only personalize offerings or messages to those who are current customers or used to interact with the brands. Upon the emergence of Internet, Web 2.0 and cloud computing, the execution of personalization has changed in which the process of personalization starts right after a totally new visitor drops by an e-commerce website for information searching and initiated either by customers (i.e. when they explicitly disclose their personal information or customize the look or contents of the webpage) or by the e-retailer by implicitly recording customers’ activities on the webpage and individualizing offerings. Moreover, in the new age of IoT with smart things when not only laptops, tablets or smartphones but also normal offline objects such as motor vehicles, household appliances, wearable things can be connected to Internet and to each other, the new storming evolution in personalization is coming. In which, real-time data from not only touch points with the brand but also from other multiple touch points can be collected. Thereby, marketers can personalize message, offerings and experience to those who even have not interacted with the brand before. Big data collected from multiple touch points within a IoT will provide a distinct and comprehensive profile of an individual such as demographics, psychographics, purchasing behaviours, what they click, what they are viewing, how long they stay at a particular page, their devices and locations and so on.

In the age of IoT, when every object and device can be connected while more and more companies compete by obtaining big data and using predictive analytics to create personalized offerings, message and transaction, customer expectation may change accordingly. Specifically, since they get used to enjoying personalized experience, they may expect personalization in every products and services they are considering to buy. Moreover, since customer satisfaction is resulted from customers’ comparison of what they expect and what they receive (Cronin et al., 2000), personalization will become one of the crucial strategy to gain customer satisfaction. Thereby, it is not just whether the company can personalize but how right, deep and wide the personalization should be the competitive edge of the firm in the future. Based on in-depth knowledge about the massive number of potential customers to whom the brand has not contacted before, the company must segment the market and identify the most valuable and suitable target market as well as tailor the marketing mix activities to personalize offerings and communication in a right, different and appealing way so as to attract these target customers. Overall, the role of personalization in the IoT age is extended in which personalization is a key factor in not only growing and maintaining relationship with current customers but also finding and winning new customers. Figure 2 features the framework of personalization in the IoT age which is modified from Vesanen (2007).

According to Coner (2003), Godin (1999), Murthi and Sarkar (2003), Pitta et al. (2004), Raab (2005), Vesanen and Raulas (2006) and Wind and Rangaswamy (2001), the execution of personalization is a process based on interaction between the customer and the marketer. However, the author argues that within a IoT, personalization is resulted from not only customer-marketer interaction but also customer-things, marketer-things and things-things interlinks. Moreover, personalized marketing output which is believed to include everything from 4Ps: promotion/communication, product/service, price or delivery (Vankalo, 2004) should be extended to website experience such as a website’s appearance, structure, content, interactions, etc. as well as process (i.e. how the transaction will be made, payment method, how customers can involve in the customization of the products or services).

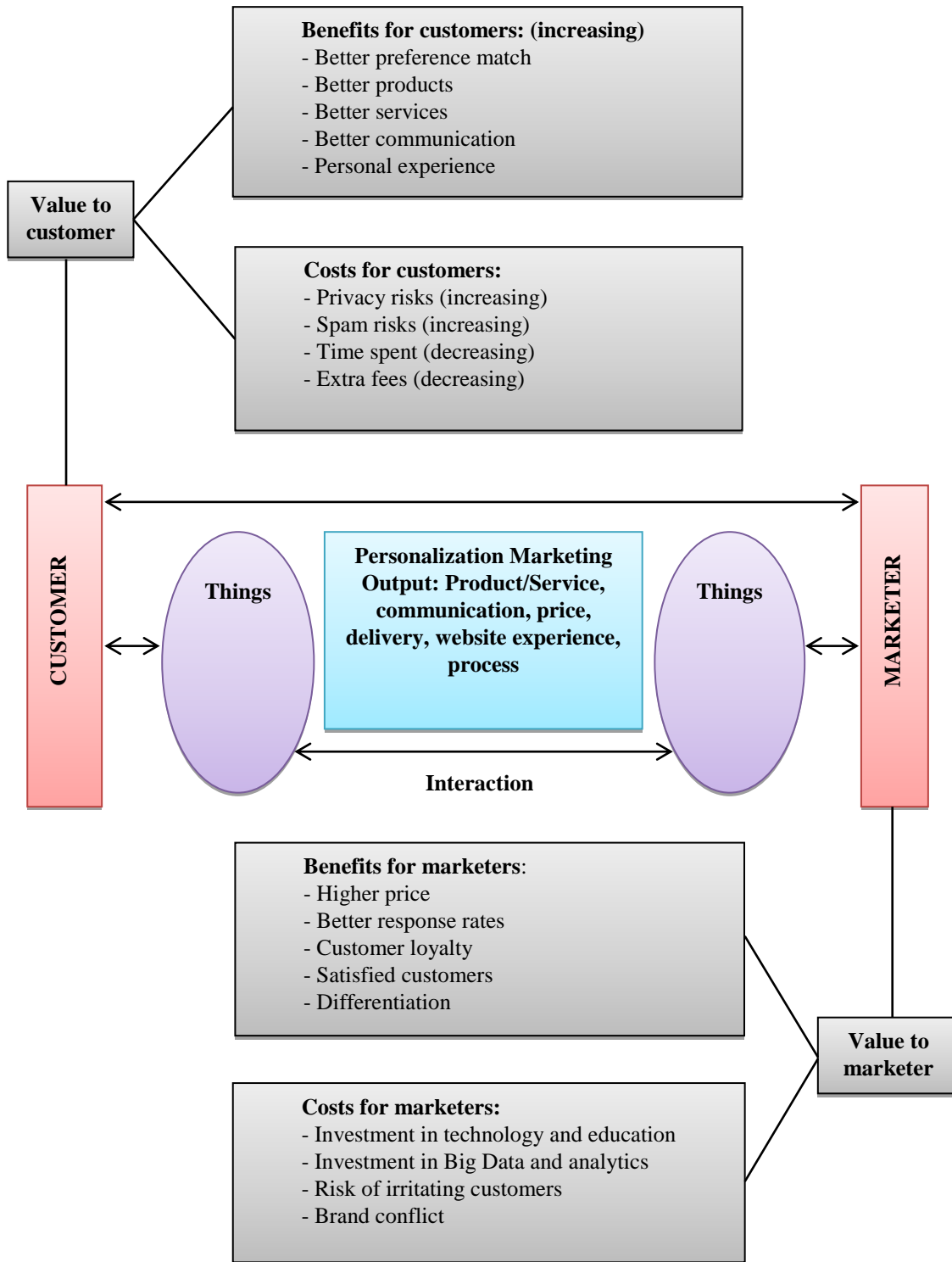

**Fig. 2. The framework of personalization in the IoT age (developed for this study)**

Obviously, customers benefit from better products, better services, more efficient communication and personal experience since the offerings and communication are personalized to match their specific preference (Coner, 2003; Godin, 1999; Hanson, 2000; Murthi and Sarkar, 2003; Peppers et al., 1999; Pitta et al., 2004; Roberts, 2003; Wind and Rangaswamy, 2001). On the other hand, personalization also comes with costs resulted from privacy risks, spam risks, time, and extra fees (Bardaki and Whitelock, 2004; Roman and Hernstein, 2004). However, when Internet of Things technologies are widely applied in industrials, retail, logistics and communication, costs and time to produce and deliver personalized products and services will gradually reduce while risks related to losing privacy and spam will increase. Overall, if privacy risks and spam risks can be resolved, value that customers receive upon the trade-off between benefits and costs resulted from personalization in the IoT age will increase. The attractiveness and importance of personalization, therefore, are enhanced upon the evolution of the IoT.

Regarding to value for marketers, the benefits and cost related to the adoption of personalization approach are considered. Benefits for the marketer include the ability to charge a higher price for the personalized offerings, better response rates, higher customer satisfaction and loyalty (Ansari and Mela, 2003; Hanson, 2000; Howard and Kerin, 2004; Peppers et al., 1999; Rust et al., 2000; Srinivasan et al., 2002; Wind and Rangaswamy, 2001). Moreover, personalization presents a unique feature of products and services (Ball et al., 2006) that forms competitive edges for the company. Since the IoT facilitates automate data collection and interpretation, Big data and predictive analytics resulted from the IoT will enable more efficient personalization practices. As a result, the benefits of personalization to marketers in the IoT on short run will increase. However, in long run, the evolution of IoT may lead to wider adoption of Big Data with lower costs that makes the number of companies which can personalize communication and offerings higher. Thereby, although personalization still plays a key role in managing customer satisfaction and loyalty, the level of personalization required to achieve customer expectation, satisfaction and loyalty as well as encourage customer response may be higher. Moreover, as discussed above, the wide spread of IoT in industrials, retail and logistics will lower the costs of personalized products and services while many firms can access the Big Data and predictive analytics, marketers may no longer charge higher prices for personalized offerings. On the other hand, huge investments are required for technological procurement and installation, training employees, or buying big data and hiring data analytics agents while the risk of irritating customers is higher due to privacy invasion and spam (Jiang, 2004; Peltier et al., 2003; Roman and Hernstein, 2004). Additionally, when products and services are personalized to those who have different and even opposite characteristics and behaviour, the brand image may be no longer consistent that leads to brand conflict, especially in the world of IoT where people are easily connected and compare what they have to each other. The value of personalization approach to marketers in the IoT, therefore, depends on their capacity and particular strategies in increasing benefits while reducing risks and costs related to personalization

Along with the evolution of the IoT, the role of personalization becomes more and more important. A recent global survey combined with in-depth interviews on 499 leading CMOs and senior marketers by the EIU has revealed that most CMOs agree on the ability to personalize customer experience through multiple touch points as a core marketing strategy and an essential tasks of marketing departments in order to create and strengthen brand values and customer loyalty from now to 2020. In addition, the Internet of Thing which is one of the three major technology-specific trends in the Fourth Industrial Revolution is the biggest driving force behind the growing importance and widely adoption of the personalization approach.

## 5. Internet of Things and opportunities for personalization practices in Vietnam

IoT has already emerged in Vietnam and being received increasing concerns from not only technicians, marketers and businessman but also the government. Developing IoT applications is believed a crucial strategy to improve enterprises' publicity and foster socioeconomic development. The following facts imply the base and potential development of IoT in Vietnam:

- According to the report of Vietnam Ministry of Information and Communication at the Symposium on Digital Citizenship and Safer Internet Day 2017, 53 per cent of the Vietnamese population is online. In addition, Vietnam has been implementing many projects to expand the Internet coverage to rural and remote areas so that the Internet penetration rate will increase faster in next few years (Viet Nam News, 2017). The number of smartphones users in Vietnam will account for around 30% of total population by the end of 2017 (Statista, 2017). The wide coverage of Internet and popular use of smartphones create the base for the evolution and application of IoT in the country
- The first IoT-based products have been either imported or created and used in Vietnam. Besides smartphones, smart watches, smart TV and ATM which are adopted from foreign countries, Vietnamese technicians can create their own IoT-based products such as Smart Home (i.e. a product of BKAV), Smart Streetlight system (i.e. a product of S3 company), V-tracking (i.e. Vehicle tracking via Internet provided by Viettel), etc. In which, Smart Home has been installed at thousands of households and apartments in Vietnam and believed to become a popular trend among Vietnamese citizens in next few years.
- Many IoT Labs has been built in Vietnam under either public and private projects ranging from small-sized and self-sourced labs to professional ones invested by major telecommunication companies such as Hoa Lac IoT Lab founded by DTT, Intell and Dell.
- Vietnamese government and local authorities has launched "Smart City" projects to encourage more ideas to applying IoT for more connections, better modern lives, higher living environment quality and sustainable development. The recent free Wifi coverage in big cities and travel points such as Hanoi, Ho Chi Minh, Can Tho, Bac Ninh, Ha Long, Hoi An Da Nang, Da Lat and Hai Phong represents a very first step to create a favourable environment for IoT adoption.

On one side, the emergence of IoT in the country indicates a major and inevitable trend in technological environment which are affecting directly customer behaviour, business operation, manufacturing, logistics and competition. In which, as discussed above, personalization will be the key marketing success factor which helps enterprises take opportunities resulted from the IoT technologies and create their own competitive advantages. On the

other side, the wide coverage of Internet and the emerging IoT in Vietnam has enabled companies, especially those operating in telecommunications, banking, finance and ecommerce to generate substantial database about Vietnamese consumers. In fact, leading telecommunications companies such as Viettel, Mobiphone and VNPT have established specialized divisions to either use or sell their data. As a result, Vietnamese companies currently have great opportunities to implement personalization strategy in finding, winning, growing and retaining customers as well as increasing values provided for both their customers and themselves.

## **6. Implications for Vietnamese enterprises and suggestions to Vietnamese government**

The IoT has emerged in Vietnam, and it is going to change the marketing environment especially customers' expectations and competition. The IoT will bring more benefits than threats for marketers if they are in a position to take advantage of the IoT in advance rather than being forced to change due to intense competition. The IoT, on one side, increases the role of personalization in marketing as a core strategy in finding, winning, growing and maintaining customers as well as building sustainable competitive advantages, on the other side; facilitates more effective and comprehensive personalization due to the increasing use of Big Data and predictive analytics. Personalization, therefore, should be practiced and widely adopted in marketing activities of Vietnamese enterprises. The development of IoT and the increasing role of personalization bring opportunities for both Vietnamese enterprises which use Big Data for personalization strategy and also those which make money from offering new products and services in the age of IoT.

### **6.1. Vietnamese enterprises which use Big Data for personalization strategy**

In order to successfully design and implement personalization strategies in the age of IoT, Vietnamese enterprises should complete three important yet difficult tasks which are collecting and analysing Big Data of both current and potential customers; using Big Data for personalization strategy ; and overcoming problems involved in personalization and IoT.

#### **Collecting and analysing Big Data**

Big Data can offer huge benefits to all Vietnamese enterprises of all sizes. Although the IoT adoption in Vietnam is still limited due to its complexity and high costs of technologies involved, it does not mean that Vietnamese enterprises cannot access to the benefits of IoT for their personality strategy since the Big Data has already been available for them to collect and exploit. In order to tap into Big Data and turn it into insights and value, businesses can select or combine two options which are outsourcing data collection and analytics and/or investing their own Big Data infrastructure.

Regarding the option of outsourcing, currently, there have been only few companies in Vietnam which officially sell data, namely Viettel, Mobiphone and VNPT while others do not collect customer data or consider customer data something private and secret, therefore, do not want to share or sell. Even if they are willing to sell data, each company may possess just a piece of "customer truth" based on the data set it has, and unfortunately, they may not know each other to exchange and build the comprehensive one. Although Vietnamese enterprises can rely on market research agency to order what types of data they want, they must bear high costs in long run since market trends may change quickly while losing control over the truthfulness of data.

Building own Big Data infrastructure is a long-term effective yet complicated solution in which a business needs to make investments on essential infrastructure elements including data collection, storage, analysis, and output or visualization. Specifically, data may come from both internal sources (i.e. sales records, customer database, social networking sites, feedback, email archives, etc.) and external ones (i.e. buying data from other companies). In order to source and read data, besides traditional tools such as survey or handwriting and typing records, depending on type of data to be collected, there are many advanced options for Vietnamese enterprises to adopt such as sensors, apps, CCTV video and beacons. Moreover, encouraging potential and current customers to disclose their information via forms on websites or tracking social media profiles are also effective data collection methods with low costs. If a business has little technical knowledge, it can cooperate with a data company to build and install the system while still managing and tracking the whole data collection process. Once data is gathered, it should be stored for later analysis. Nowadays, thanks to the development of Cloud Computing, businesses can store huger amount of data with lower costs and more flexibility than using regular hard disks or setting up data warehouse. Finally, so as to analysing and turning data into insights, business can look for some software offered by IBM, Oracle, Google, Cloudera, Amazon Web Services, Microsoft HDInsight. The advantage of building Big Data infrastructure is that businesses can have high control over the quality and value of Big Data. Though this option may be costly in short run, however, upon the rapid development of IoT and the emergence of new start-up firms in this field, the cost of setting up Big Data infrastructure will reduce in the near future.

#### **Using Big Data for personalization strategy**

After acquiring Big Data, businesses can gain insights about who and where their targets customers are as well as their purchasing behaviour, tastes or preferences. In order to incorporate this knowledge into marketing strategies and



personalize customers' experience, Vietnamese enterprises should firstly understand the value of the customer orientation and follow this philosophy as their vital business culture in every daily marketing activity across all customer contact points. In doing so, all employees should be trained to be customer-oriented. Moreover, each marketing decision should be started with the questions such as "Who is the customer", "How customers will perceive it and whether they perceive differently"; "How the customers like to be treated or communicated", "Is it beneficial and suitable for different customer groups"; "How different customers may react to it", etc. While answering such questions, businesses must use information from Big Data and that is the effective way for them to include Big Data in designing personalization strategy. Furthermore, Vietnamese enterprises should update and adopt new technology to personalize their offerings and communication to customers as much as they can so that each customer will be treated personally in the way they want at lower costs.

#### **Overcoming problems involving in personalization and the IoT**

As discussed above, when data sets are shared and personalization is adopted in marketing, customers may face privacy and spam risks while marketers may face the risks of irritating customers and brand conflict. In order to reduce the privacy and spam risks, every enterprise should firstly understand the value of data and consider it as a "commodity" which can be traded or exchanged for profits or benefits. Specifically, since such data is provided by the customers either implicitly or explicitly, the customers, as the sellers, should be asked to decide whether they are willing to provide it, to whom the data will be transferred and for what purposes. Besides, customers should have some benefits in data exchange. Upon the customers' approval, each company which owns the data can resell it to each other while the customers are well-informed and prepared for what may happen since they have already sold their information. Moreover, enterprises should allow customers to have an option to "opt-out" whenever they do not want to connect with them anymore as a way to respect to customers. Finally, the brand conflict resulted from personalization practices can be resolved by well-defined target customer selection and positioning before personalization strategy is tailor-made.

### **6.2. Vietnamese enterprises which make money from offering new products and services in the age of IoT**

The increasing role of personalization in the age of IoT also implies many opportunities for Vietnamese enterprises, especially start-up firms in offering new ranges of products and services which are highly personalized, therefore, would be extremely competitive in the market as well as supporting services which help other firms in collecting, analysing and using Big Data for their personalization strategy. Specifically, despite the benefits of personalization in marketing, many Vietnamese firms may find difficult to set up and manage their own Big Data infrastructure due to limitations in financial budget or human resources. As a result, in the coming time, demand on training, advising, designing and doing marketing research, collecting data from internal and external sources, middleman in data exchanging, developing apps, data storage, data analytics and data presentation, etc. will be very high. These are valuable sources to generate new business ideas.

### **6.3. Suggestions to Vietnamese government**

Similarly to enterprises, Vietnamese government can also encourage governmental offices to gather information from citizens for personalizing public services as a way to enhance citizens' satisfaction. Moreover, when the "Smart city" projects come into life, citizens' data can be generated and collected from multiple contact points that will then support Vietnamese government itself and may be shared to other Vietnamese enterprises in personalizing products, services and communication.

In the age of IoT where the value of data is acknowledged, "data" will become a sensitive commodity which may benefit the users while creating inconveniences and risks to the owners. So as to protect the rights of the customers and data owners while encouraging the development and adoption of Big Data in public and private sectors, Vietnamese government should pass by new laws and regulations related to the disclosure, exchange and usage of personal data. Moreover, the government should make and implement policies to encourage the formation of data exchange market where "data sellers" and "data buyers" can meet up and exchange officially and legally to build more comprehensive and effective Big Data serving personalization strategies.

### **Reference**

- [1] Adomavicius, D. & Tuzhilin, A. (2006). Personalization technologies: A process-oriented perspective. *Wirtschaftsinformatik*, 48 (6), 449-450
- [2] Ansari, A. & Mela, C. (2003). E-customization. *Journal of Marketing Research*, 40, 131-145
- [3] Anthem Marketing Solutions (2016). *The Internet of Things: Background and Marketing Impact*. Anthem Marketing Solutions
- [4] Ashton, K. (2009). That 'internet of things' thing. *RFID Journal*, 22 (7), 97-114.
- [5] Ball, D.; Coelho, P.S. & Vilares, M.F. (2006). Service personalization and loyalty. *Journal of Services Marketing*,

- 20 (6), 391-403.
- [6] Bardaki, A. & Whitelock, J. (2004), "How ready are customers for mass customisation? An exploratory investigation", *European Journal of Marketing*, 38 (11/12), 1396-417.
- [7] Coner, A. (2003). Personalization and customization in financial portals. *Journal of American Academy of Business*, 2 (2), 498-504.
- [8] Densai, D. (2016). A study of Personalization Effect on Users' Satisfaction with E-commerce websites. *Journal of Management & Research*, 6 (2), 51-62
- [9] Doug Riecken (2000). Personalized views of personalization. *Communications of the ACM*, 43(8), 26-28
- [10] du Pre Gauntt, J. & Stahl, G. (2016). The path to 2020: Marketers seize the customer experience. The Economist Intelligence Unit.
- [11] Fan, H. and Poole, M.S. (2006). What is personalization? Perspectives on the Design and Implementation of Personalization in Information Systems. *Journal of Organizational Computing*, 16 (3/4), 179-202
- [12] Fielding, R. T., & Taylor, R. N. (2002). Principled design of the modern web architecture. *ACM Transactions Internet Technology*, 2 (2), 115-150.
- [13] Godin, S. (1999). *Permission Marketing*. New York: Simon & Schuster.
- [14] Guinard, D., Trifa, V., Pham, T., & Liechti, O. (2009). Towards physical mash ups in the web of things. *Proceeding IEEE Sixth International Conference on Networked Sensing Systems (INSS 09)*, Pittsburgh, PA , 196 – 199.
- [15] Greene, J. (2015). TIM Lecture Series: The Internet of Everything: Fridgebots, Smart Sneakers, and Connected Cars. *Technology Innovation Management Review*, 5 (5), 47-49.
- [16] Hanson, W. (2000). South Western, Cincinnati, OH: *Principals of Internet Marketing*.
- [17] Howard, D. & Kerin, R. (2004). The effects of personalized product recommendations on advertisement response rates: the try this. It works! Technique. *Journal of Consumer Psychology*, 14 (3), 271-80.
- [18] IERC (2013), Coordinating and building a broadly based consensus on the ways to realise the internet of things in Europe, [assessed 2017 May 21], available from [http://www.internet-of-things-research.eu/pdf/Poster\\_IERC\\_A0\\_V01.pdf](http://www.internet-of-things-research.eu/pdf/Poster_IERC_A0_V01.pdf)
- [19] Imhoff, C., Loftis, L. & Geiger, J. (2001). *Building the Customer-Centric Enterprise, DataWarehousing Techniques for Supporting Customer Relationship Management*. New York: John Wiley & Sons.
- [20] International Telecommunication Union (2012). *Overview of the Internet of things. Series Y: Global Information infrastructure, Internet Protocol aspects and next-generation networks, Y.2026*
- [21] Jiang, P. (2004). The role of brand name in customisation decisions: a search vs. experience perspective. *Journal of Product and Brand Management* , 13 (2), 73-83.
- [22] Jiang, L., Xu, L., Cai, H., Jiang, Z., Bu, F., & Xu, B. (2014). An IoT oriented data storage framework in cloud computing platform. *IEEE Transactions on Industrial Informatics*, 10 (2), 1443 – 1451
- [23] Kirtsis, D. (2011). Closed-loop PLM for intelligent products in the era of the internet of thing. *Computer- Aided Design*, 43 (5), 479 – 501.
- [24] Li, S., Xu, L., & Wang, X. (2013). Compressed sensing signal and data acquisition in wireless sensor networks and internet of things. *IEEE Transactions on Industrial Informatics*, 9 (4), 2177 –2186
- [25] Li, S.; Xu, L.D. & Zhao, S. (2015). The internet of things: a survey. *Information Systems Frontiers*, 17, 243-259.
- [26] Li, Y.; Hou, M.; Liu, H. & Liu, Y. (2012). Towards a theoretical framework of strategic decision, supporting capability and information sharing under the context of Internet of Things. *Information Technology and Management* , 13 (4), 205-216.
- [27] Murthi, B. & Sarkar, S. (2003). The role of the management sciences in research on personalization", *Management Science*, 49 (10), 1344-1362.
- [28] Peppers, D. & Rogers, M. (1993). *The One to One Future: Building Relationships One Customer at a Time*. New York: Currency/ Doubleday.
- [29] Peppers, D., Rogers, M. and Dorf, B. (1999). *The One to One Fieldbook: The Complete Toolkit For Implementing a 1 to 1 Marketing Program*. New York: Double Day
- [30] Peltier, J., Schibrowsky, J. & Schultz, D. (2003). Interactive integrated marketing communication: combining the power of IMC, the new media and database marketing. *International Journal of Advertising* , 22 (1), 93-115.
- [31] Pitta, D., Franzak, F. & Little, M. (2004). Maintaining positive returns in the value and supply chain: applying tomorrow's marketing skills. *Journal of Consumer Marketing*, 21 (7), 510-519.
- [32] Raab, D. (2005). Advanced personalization. *DM Review*, 15 (4), 55-57.
- [33] Ren, L.; Zhang, L.; Tao, F.; Zhang, X.; Luo, Y., & Zhang, Y. (2012). A methodology towards virtualization based high performance simulation platform supporting multidisciplinary design of complex products. *Enterprise Information Systems*, 6 (3), 267-290.
- [34] Roberts, M. (2003). *Internet Marketing: Integrating Online and Offline Strategies*. Boston: McGraw-Hill.
- [35] Roman, E. & Hernstein, S. (2004). *Opt-in Marketing*. New York: McGraw-Hill.
- [36] Ross, N. (1992). *A history of direct marketing*. New York: Direct Marketing Association.
- [37] Rust, R., Zeithaml, V. and Lemon, K. (2000). *Driving Customer Equity: How Customer Lifetime Value Is*

Reshaping Corporate Strategy. New York: The Free Press.

- [38] Srinivasan, S., Anderson, R. and Ponnayolu, K. (2002). Customer loyalty in e-commerce: an exploration of its antecedents and consequences. *Journal of Retailing*, 78 (1), 41-50.
- [39] Statista (2017). Number of smartphone users in Vietnam from 2015 to 2021 (in millions), [assessed 2017 May 21], available from <https://www.statista.com/statistics/467739/forecast-of-smartphone-users-in-vietnam/>
- [40] Tao, F., Zuo, Y., Xu, L., & Zhang, L. (2014). IoT based intelligent perception and access of manufacturing resource towards cloud manufacturing. *IEEE Transactions on Industrial Informatics*, 10 (2), 1547 – 1557.
- [41] Vankalo, M. (2004). Internet-Enabled Techniques for Personalizing the Marketing Program. Swedish School of Economics and Business Administration, Helsinki.
- [42] Vesanen, J. & Raulas, M. (2006). Building bridges for personalization – a process model for marketing. *Journal of Interactive Marketing*, 20 (1), 1-16.
- [43] Vesanen, J. (2007). What is personalization? A conceptual framework. *European Journal of Marketing*, 41 (5/6), 409-418
- [44] Viet Nam News (2017). Viet Nam strives to up internet oversight, [assessed 2017 May 21], available from: <http://vietnamnews.vn/economy/351694/viet-nam-strives-to-up-internet-oversight.html#E3a76PmYYhtK27E7.99>,
- [45] Wang , C., Bi , Z ., & X u, L. (2014 ). IoT and cloud computing in automation of assembly modeling systems. *IEEE Transactions on Industrial Informatics*, 10 (2), 1426 – 1434
- [46] Wind, J. and Rangaswamy, A. (2001). Customerization: the next revolution in mass customization. *Journal of Interactive Marketing*, 15 (1), 13-33.

# Prediction of Financial Distress for Companies Listed in Vietnam Securities Market

**Vu Thi Loan\***

PhD candidate, Thainguyen University of Economics and Business Administration, Thainguyen Province, Vietnam

## ABSTRACT

This article is designed to construct a financial distress prediction model for companies listed in Vietnam securities market. A company is recognized as financial distressed if its stocks are required to be delisted by the Securities Exchanges in the period of 2009 and 2015. In order to discover the role of stock price as a symptom of a company's financial distress, 2 prediction models using discriminant analysis are established: model 1 contains financial ratios purely taken from companies' financial statements while model 2 adds stock price as an independent variable in the model. The model's performance analysis results show that both models can reach high level of prediction accuracies in 1 or 2 years prior to the distress event. Comparison results between two models state that model with stock price outperforms model without stock price. In addition, the results also demonstrate the significant prediction power of some financial ratios so that the managers can control to avoid company's financial distress.

**Keywords:** financial distress; financial distress prediction; discriminant model; financial ratios; listed companies

## 1. Introduction

Financial distress is used to refer to a condition as companies encounter their business failure that make them fail to cover their financial obligations and may lead to bankruptcy or business discontinuation. For a listed company, financial distress brings large economic losses to companies' stakeholders such as the owners, employees, investors. Furthermore, companies' financial distress may threaten the sustainable development of the financial market and macroeconomics in general.

Financial distress prediction known as the forecast of financial distress from the symptoms in the past of a company generates intensive interest from researchers in several decades because of the outbreak of financial crisis worldwide. Financial distress prediction model have been constructed with various prediction features and analysis techniques that can be classified into traditional models and modern models. Traditional models such as univariate model [4], Z-score models [1] [2] [3] or Logit model [17] and models with modern machine learning techniques such as Decision Tree - DT [19], Support Vector Machine – SVM [6]. In terms of financial distress predictors, existing literature discloses an important role of market information, macroeconomic ratios and financial ratios as alarms for company's financial distress. Among those existing literature, the research of Lin et al. [14] provides extremely significant findings on choosing the financial ratios as predicting features in a forecast model.

In Vietnam, studies relating to companies' financial distress prediction mainly focus on bankruptcy forecast and credit scoring system in commercial banks with the application of Z-score models from Altman [1] [2] [3]. Hay Sinh [12] estimates the bankruptcy probability of The Southern Rubber Industry Joint Stock Company – CASUMINA while Dao Thi Thanh Binh [10] establishes the credit scoring model for manufacturing firms in Vietnam using Altman [1]. The main limitation of the studies taken in Vietnam is the lack of significance test of those models on the data in Vietnam before presenting the prediction results. Moreover, the financial distress in researches taken in Vietnam is recognized as bankruptcy only while the financial distress measures have been expanded from bankruptcy to many specific forms of business failure such as stock delisting or special treatment of listed stocks.

Because of the insufficiency of related researches for listed companies carried out in Vietnam, this study is

\* Tel.: +840974943069

Email: Loanvu.ktn@gmail.com

conducted to construct a financial distress prediction model for companies listed in Vietnam securities market using the financial distress recognition of stock delisting as required by the Stock Exchanges in Vietnam. In order to measure the prediction role of market information, the company's stock market price is added as an independent variable of the model together with a set of financial ratios proposed by Lin et al. [14]. The analysis results of the article are expected to provide significant supports to the managers of listed companies and the companies' investors to make important financial management and investing decisions.

## 2. Literature review

### 2.1. Financial distress recognition

Financial distress was firstly introduced by Beaver [4] as failure when company lacks ability to cover the financial obligations such as debts, preferred dividend payments. The financial distress events can be bankruptcy, bond default, overdrawn bank accounts or nonpayment of preferred stock dividend. Chan and Chen [7] defined financially distressed firms as those that "have lost market value because of poor performance, they are inefficient producers, and they are likely to have high financial leverage and cash flow problems. They are marginal in the sense that their prices tend to be more sensitive to changes in the economy, and they are less likely to survive adverse economic conditions."

The financial distress events were then extended to the lack of equity, the inadequacy of liquid assets including cash, bank accounts and short-term financial assets [5] or negative net assets [9]. In the Z-score [1], Z'-score [2] and Z''-score [3], a company is considered as financial distressed when it goes bankruptcy. In their study, Ross, Westerfield, and Jaffe [18]) summarize the literature on the financial distress definitions and state that financial distress can be realized as business failure, bankruptcy and negatives net assets.

Recently, financial distress problem of listed companies in developing and emerging markets attracts huge attention from researchers. Therefore, the definition of financial distress is closely related to the market principles. For example, in a study on securities market in China, a financial distressed company is the one on the Special Treatment list provided by China Securities Commission [8]. However, Ding, Song & Yen [8] selects companies that make losses in two consecutive years into financial distress group while Uğurlu and Aksoy [20] consider companies with accumulated loss bigger than equity capital or making 2/3 loss in equity are financial distressed.

It can be seen that the company's financial distress recognitions vary in existing literature. However, these different measures can be summarized to obtain a common understand of financial distress which is known as the condition that a company has business failure so that it lacks liquidity assets to cover their financial obligations that may lead to bankruptcy or business discontinuation.

### 2.2. Financial distress prediction model

Financial distress prediction can be explained as an activity to predict the financial distress condition of a company in the future from the past symptoms [16]. From the very first study of Beaver [4], constructing financial distress prediction models has been an interesting objective of researchers all over the world.

According to Lin, Liang and Chen [13], there are two determinants of a financial distress prediction model's accuracy. They are the choice of predictors and the technique to classify companies in the sample used in the prediction model. Related to the first factor, financial ratios collected from the financial statements of companies are the major predicting features of model in existing studies. It has been proved that those financial ratios such as liquidity, solvency, profitability, have significant role in predicting the company's financial distress. In addition, it is very convenient for the researchers to collect data on those ratios because of their availability. However, the big limitation of using financial ratios as independent variables is that those ratios are calculated from the accounting reports constructed from some accounting principles such as the conservatism principle, cost principle and going concern assumption so that the real value of assets may be different with the book value of assets. In addition, the accounting information of the company may be manipulated for the management purposes. However, despite of concerns on using accounting ratios for prediction, these ratios are used widely in almost all empirical studies. Beaver [4] even states that accounting ratios can predict financial distress of a company at least 5 years prior to the financial distress event. Other variables besides financial ratios also demonstrate their importance in financial distress prediction. They can be listed as interest rates, inflation rate, unemployment rate, currency exchange rates, money supply and public budget surplus or deficit. In some financial distress models, it can be observed that there is high probability of financial distress rate at recession period because of high financial expenses and sale decrease.

The second determinant of financial distress prediction' accuracy is the classifiers in the prediction model. From the univariate technique used in one of the first related studies of Beaver [4], the classifier has developed to multivariate technique by Altman [1] [2] [3], Logit by Ohlson [17] or machine learning algorithm such as Decision Tree (DT) by Tam & Kiang [19] or Support Vector Machine (SVM) by Chandra, Ravi,& Bose [6]. In those classifiers, multivariate analysis is applied widely in prediction of not only bankruptcy but also other financial distress measures such as failure.

Review of studies on financial distress topic shows that Lin et al. [14] provide an advanced approach to select the

predictors in a financial distress prediction model by integrating expert knowledge and wrapper method. There are 2 steps in wrapper method. In the first step, ratios are clustered by several groups of Leverage ratios, Liquidity ratios, Operational ratios, Profitability ratios, and Solvency ratios. In the second step, ratios in the same category are regrouped according to their correlation. Two ratios with high correlation are in the same sub-group. In the last step, the GA-based wrapper algorithm is used to choose one ratio that can be the representative of a sub-group. From 44 ratios known as experiment variables which are classified into seven main categories, Lin et al. [14] choose 22 pairs and select one ratio in each pair. After examining the t-test results, seventeen ratios are put in the model. The application of financial distress prediction model with predictors taken from the proposed integrated method shows that this model significantly outperforms other existing feature selection approaches in literature. Therefore, it is interesting to discover how this approach works with other datasets especially in a new operation market in Vietnam.

### 3. Methodology

#### 3.1. Description of variables

This study is performed to establish a financial distress model for companies listed in Vietnam securities market using discriminant analysis which is proven to be an effective classifier [1] [2] [3]. The independent variables which are presented in table 1 are taken mainly from analysis results of Lin et al. [14]. In order to measure the reflection of the current and the past financial information of the company on the company's stock price so that stock price can be the good predictor of company's financial distress in the future, the current stock price is also included as an independent variable in the model ( $X_{21}$ ).

In a model, the dependent variable measures the financial distress condition of a company. It is event of being delisted as the requirement of the Stock exchanges in Vietnam. This is a dummy variable with 2 values, 1 for non-financial distressed company and 0 for financial distressed company.

**Table 1. Classifications of prediction variables**

Variable	Description
Liquidity ratios	
$X_1$	Current ratio
$X_2$	Acid test
$X_3$	Working capital/total assets
$X_4$	Working capital/sales
$X_5$	No-credit interval
Solvency ratios	
$X_6$	Interest expenses/equity
$X_7$	Market value equity/book value of total debt
$X_8$	Interest expense/revenue
Growth ratios	
$X_9$	Total assets growth
Cash flow ratios	
$X_{10}$	Cash flow/total assets
$X_{11}$	Cash flow/total liabilities
$X_{12}$	Cash flow/equity
Operational ratios	
$X_{13}$	Total assets turnover
Profitability ratios	
$X_{14}$	Operating income after tax per share
$X_{15}$	Retained earnings/total assets
$X_{16}$	Operating income before tax/total assets
$X_{17}$	Operation income per employee
$X_{18}$	Gross profit/net sales
$X_{19}$	Net Income/equity
Capital structure ratios	
$X_{20}$	Liabilities/total assets
$X_{21}$	Current market stock price

#### 3.2. Data collection

The sample of the study consists of 2 groups of companies: financial distressed companies and non-financial

distressed companies collected from 2009 to 2015. In this period, there are 140 companies whose stocks are required to be delisted by Hanoi Stock Exchange and Hochiminh Stock Exchange so that these 140 companies are chosen into the sample. The researcher selects the same number of non-distressed companies so that there are 140 pairs of companies in the sample. Two companies (one distressed and one non-distressed) in a pair have the same characteristics of industry, size and age. Data are collected in 1 and 2 year before the financial distress event or before the company's stocks are required to be delisted. For example, if the company is financial distressed in 2015, the data of this company will be collected in two years: 2014 and 2013. However, because of the unavailability of some companies' data, there is a change in the real number of companies in the sample compared to the expected sample size. The number of companies in the sample used for analyzing is presented in table 2 below.

**Table 2. The sample size**

	Financial distressed company	Non-financial distressed company
1 - year ahead	132	116
2 - year ahead	125	125

### 3.3. Data analysis

The discriminant analysis is used to classify each company on the sample into one group of financial distress group or non-financial distress group according to the company's discriminant score calculated from the model. The discriminant score is computed based on the weights of the independent variables or the weights of predictors. The linear discriminant function with variable's weights is presented below:

$$D = b_0 + b_1X_1 + b_2X_2 + b_3X_3 + \dots + b_kX_k \quad (1)$$

D: Discriminant score

b: weight

X: independent variable

The model applies the maximum likelihood technique to classify a company from a cut-off point. The cut-off is the mean point if the group size is equal. If the group size is not equal, the cut-off point is calculated from weighted means.

To perform this analysis, the data is separated into 2 parts with the same number of distressed firms and non-distressed firms in each part. The first part is called the analysis sample used to estimate the discriminant function while the second part is the validation sample to test the accuracy of the function.

## 4. Results and discussion

In this study, in order to investigate the impact of stock price on the hazard rate of being financial distressed of a listed company in Vietnam securities market, 2 models have been constructed. Model 1 includes 20 variables as explanation of financial distress which have been introduced by Lin et al. [14]. This model is applied to data taken in 2 points of time: 1 year and 2 year prior to financial distress event. Model 2 adds stock price as one predictor besides the same set of independent variables as in model 1 to reach the number of variables of 21. Similar to model 1, model 2 is also analyzed in 1 and 2 years before the financial distress event. In part 4, the validity and accuracy of the constructed financial distress prediction model are discussed.

### 4.1. Discussion of model's validity and significance

Before checking the ability of the model to predict the company's financial distress, the validity of the model is tested by looking at Wilk's lambda and Eigenvalue. Wilk's lambda in the range of 0 and 1 measures the variance of dependent variable which is not explained by the discriminant function. Therefore the smaller Wilk's lambda calculated in the model is preferred. Eigenvalue reflects the homogeneity of covariance matrices. The larger Eigenvalue estimated the more of the dependent variable's variance is explained by the discriminant function.

Table 3 presents the Eigenvalues of models in 2 point of prediction. The canonical correlations estimation show that nearly 74% and 66% of the dependent variable's variance are explained by the discriminant function in 1-year-ahead prediction models and 2-year-ahead prediction models, respectively.

**Table 3. Eigen values of models**

Function	Eigenvalue	% of Variance	Cumulative %	Canonical Correlation
<b>Model 1</b>				
1-year-ahead prediction	1.147	100	100	0.731
2-year-ahead prediction	0.733	100	100	0.650

**Model 2**

1-year-ahead prediction	1.147	100	100	0.731
2-year-ahead prediction	0.746	100	100	0.654

Source: SPSS 20.0

As described in table 4, the Wilks' Lambda of 1-year-ahead forecast and 2-year-ahead forecast models are small enough to ensure the validity of these models.

**Table 4. Wilks' Lambda of models**

Test of Function(s)	Wilks' Lambda	Chi-square	df	Sig.
<b>Model 1</b>				
1-year-ahead prediction	0.466	90.563	9	0
2-year-ahead prediction	0.577	66.562	6	0
<b>Model 2</b>				
1-year-ahead prediction	0.573	67.13	7	0
2-year-ahead prediction	0.573	67.13	7	0

Source: SPSS 20.0

The original model 1 includes 20 independent variables and model 2 includes 21 independent variables . However, as presented in Appendix 01, 02, the results of significance test of each variable show that variables with significance level bigger than 0.05 should be removed from the model. Therefore there can be seen a significant change in the number of prediction variables as the final 1-year ahead forecast model 1 contains only 9 variables while the final 2-year ahead forecast model 1 contains only 6 independent variables.

Table 5 explains the beta weights in the regression model of independent variables. These weights are the standardized discriminant function coefficients which measure the level of importance of the features in predicting the variables. It can be concluded from the table that X<sub>14</sub> and X<sub>19</sub> play larger role in financial distress prediction compared to other variables.

**Table 5. Standardized Canonical Discriminant Function Coefficients of the models**

1 year-ahead prediction- Model 1		2 year-ahead prediction- Model 1		1 year-ahead prediction- Model 2		2 year-ahead prediction- Model 2	
X <sub>3</sub>	-0.060	X <sub>13</sub>	0,238	X <sub>3</sub>	0,105	X <sub>13</sub>	0,247
X <sub>9</sub>	0.188	X <sub>14</sub>	0,287	X <sub>9</sub>	0,048	X <sub>14</sub>	0,293
X <sub>10</sub>	-0,109	X <sub>15</sub>	-0,237	X <sub>10</sub>	-0,072	X <sub>15</sub>	-0,235
X <sub>13</sub>	0.239	X <sub>16</sub>	-0,474	X <sub>13</sub>	0,146	X <sub>16</sub>	-0,371
X <sub>14</sub>	0.549	X <sub>17</sub>	0,011	X <sub>14</sub>	0,309	X <sub>17</sub>	0,029
X <sub>15</sub>	0.171	X <sub>19</sub>	1,322	X <sub>15</sub>	-0,034	X <sub>19</sub>	1,269
X <sub>16</sub>	-0.133			X <sub>16</sub>	-0,292	X <sub>21</sub>	-0,149
X <sub>19</sub>	0.475			X <sub>19</sub>	0,667		
X <sub>20</sub>	-0.126			X <sub>20</sub>	0,047		
				X <sub>21</sub>	0,826		

Source: SPSS 20.0

**4.2. Performance comparison between model 1 and model 2**

In the discriminant approach for financial distress prediction, a discriminant function is established according to data in the estimation samples collected at 1 and 2 years before financial distress event. In each function, the dependent variable is labeled 0 for financial distressed company and 1 for non-financial distressed company. This discriminant function will be applied to predict the financial condition for data in validation samples. This part presents the comparison of forecast accuracies results as well the error rates among models. Compared to the accuracy level of 86.4% in model 1, model 2 adding stock price as a predictor can predict higher accuracy of 93.6% in 1 year before the financial distress event. Similarly, when conducting prediction in 2 year ahead, the model with stock price (84.15%) also outperforms the model without stock price (82.5%).

**Table 6. Comparison of prediction accuracies among models**

	Model 1	Model 2
1-year-ahead prediction	86,4%	93,6%



2-year-ahead prediction

82,5%

84,1%

Source: SPSS 20.0

The comparison of performance among models in different prediction point of time can be taken by looking at the error rates in classifying of those models. Type I error is an error that a financial distressed company is classified as non-distressed company while type II error is in the case that a non-financial distressed company is predicted to be distressed by the model. Therefore, a good model should generate lower type I error as type I error brings huge potential losses to the users. As described in table 7, model 2 contains lower type I error rates in both years of prediction while type II error rates in this model are quite similar with the ones in model 1. Therefore, model 2 outperforms model 1 in terms of the model's error rates.

**Table 7. Comparison of prediction errors among models**

	Model 1		Model 2	
	1-year-ahead	2-year-ahead	1-year-ahead	2-year-ahead
Type I error	27.5	14.9	3.9	11.9
Type II error	4.1	20.3	8.1	20.3

Source: SPSS 20.0

Table 8 measures the group centroids of 2 model which are the mean of group's discrimination scores. These scores are used to compute the cutting point in order to classify a company into distressed or non-distressed group. For example, as the discriminant score of a company in model 2 at 1 year prior to financial distress event is 0.004, a company is predicted to be finance distressed if its discriminant score is smaller than 0.004 while the company is forecasted to be non-financial distressed if its discriminant score is greater than 0.004.

**Table 8. Functions at Group Centroids of model 1 and model 2**

		Model 1		Model 1	
		1-year-ahead	2-year-ahead	1-year-ahead	2-year-ahead
<b>Group centroids</b>	<b>0</b>	1.448	-0.823	-1.301	-0.83
	<b>1</b>	0.703	0.877	0.868	0.88
<b>Cutting point</b>		1.00100	0.00000	0.00400	-0.00214

Source: SPSS 20.0

## 5. Conclusion

In this paper, both models (model 1 and model 2) consist a set of financial ratios to predict the financial distress of companies listed in Vietnam securities market. Compared to model 1, model 2 contains one more independent variable which reflects the current market price of a company' stock. The discriminant analysis is applied to the data taken from companies whose stock's were required to be delisted in the period of 2009 and 2015 and companies whose stocks are listing in the market. From 20 prediction features introduced by Lin et al. (2014), the number of independent variables reduced to 9 independent variables in model 1 and 6 variables in model 2 according to the results of validity and significance test.

The results of analyzing 2 financial distress prediction models emphasize the superior of integrating approach suggested by Lin et al. [14] in selecting the financial distress predictors. It is explained that those models obtain high level of prediction accuracies (over 80%) when they are applied into the dataset taken in newly opening securities market in Vietnam with different distress measures from the one in original models. The other main finding of the research is the recognition of the prediction power of stock price as the model that includes stock price as independent variable outperforms the model without stock price in terms of accuracy level as well as type I error rates. The analysis results also state that some financial ratios can be good alarms for a company's financial distress such as ratios reflecting liquidity, asset growth and profitability of the companies.

The study's findings in this article provide a suggestion for the managers of listed companies as well as the investors in the securities market to choose an appropriate model for financial distress prediction. The managers of a listed company can use the suggested model in the study to predict company's financial condition in 1 to 2 years from the current time. The prediction results will bring recommendations for the managers to adjust their financial management strategies in order to avoid being delisted. For the investors in the market, the prediction model can be used to forecast the future financial condition of a company for giving investing decisions.

**Appendix A. Tests of equality of group means for model 1**

	<b>Sig.</b>
X <sub>1</sub>	0.388
X <sub>2</sub>	0.972
X <sub>3</sub>	0.000
X <sub>4</sub>	0.110
X <sub>5</sub>	0.900
X <sub>6</sub>	0.381
X <sub>7</sub>	0.617
X <sub>8</sub>	0.443
X <sub>9</sub>	0.016
X <sub>10</sub>	0.035
X <sub>11</sub>	0.102
X <sub>12</sub>	0.633
X <sub>13</sub>	0.000
X <sub>14</sub>	0.000
X <sub>15</sub>	0.000
X <sub>16</sub>	0.000
X <sub>17</sub>	0.585
X <sub>18</sub>	0.652
X <sub>19</sub>	0.000
X <sub>20</sub>	0.000

Source: SPSS 20.0

**Appendix B. Tests of equality of group means for model 2**

	<b>Sig.</b>
X <sub>1</sub>	0.143
X <sub>2</sub>	0.579
X <sub>3</sub>	0.329
X <sub>4</sub>	0.121
X <sub>5</sub>	0.590
X <sub>6</sub>	0.085
X <sub>7</sub>	0.136
X <sub>8</sub>	0.169
X <sub>9</sub>	0.366
X <sub>10</sub>	0.386
X <sub>11</sub>	0.152
X <sub>12</sub>	0.354
X <sub>13</sub>	0.000
X <sub>14</sub>	0.000
X <sub>15</sub>	0.000
X <sub>16</sub>	0.000
X <sub>17</sub>	0.001
X <sub>18</sub>	0.090
X <sub>19</sub>	0.000
X <sub>20</sub>	0.139

Source: SPSS 20.0

**References**

- [1] Altman, E.I., (1968). Financial Ratios, discriminant analysis and the prediction of corporate bankruptcy. *Journal of Finance*, 23(4), 589-609.
- [2] Altman, E.I., (1983). *Corporate financial distress and bankruptcy: A complete guide to predicting and avoiding distress and profiting from bankruptcy* (1st ed). John Wiley and Sons.
- [3] Altman, E.I., (1995). *Corporate financial distress and bankruptcy: A complete guide to predicting and avoiding distress and profiting from bankruptcy* (2nd ed). John Wiley and Sons.
- [4] Beaver, W., (1966). Financial ratios as predictors of failure. *Journal of Accounting research*, 4, 71-111.
- [5] Carminchael, D.R., (1972). The auditor's reporting obligation. *Auditing Research Monograph*, 1, 92-94.
- [6] Chandra, D.K., Ravi, V., & Bose, I., (2009). Failure prediction of dotcom companies using hybrid intelligent

- techniques. *Expert Systems with Applications*, 36, 4830-4837, <http://dx.doi.org/10.1016/j.eswa.2008.05.047>.
- [7] Chan, K. and N. Chen., (1991). Structural and Return Characteristics of Small and Large Firms. *Journal of Finance*, 46, 1467-1484.
- [8] Ding, Y., Song, X., & Yen, Y., (2008). Forecasting financial condition of Chinese listed companies based on support vector machine. *Expert System with Applications*, 34(4), 3081-3089.
- [9] Doumplos, M., & Zopounidis, C., (1999). A multinational discrimination method for the prediction of financial distress: the case of Greece. *Multinational finance Journal*, 3(2), 71-101.
- [10] Đào Thị Thanh Bình., (2013). Mô hình xếp hạng tín dụng cho các công ty sản xuất ở Việt Nam. *Tạp chí Kinh tế và Phát triển*, 188, 39-49.
- [11] Fitzpatrick, P.J., (1934). A Comparison of the ratios of successful industrial enterprises with those of failed companies. *The Certified Public Accountant*, 598-605.
- [12] Hay Sinh (2013). Ước tính xác suất phá sản trong thẩm định giá trị doanh nghiệp. *Phát triển & Hội nhập*, 8(18), 52-57.
- [13] Lin, F., Liang, D., & Chen, E., (2011). Financial ratio selection for business crisis prediction. *Expert Systems with Applications*, 38(12), 15094–15102.
- [14] Lin, F., Liang, D., Yeh, C. & Huang, J., (2014). Novel feature selection methods to financial distress prediction. *Expert Systems with Applications*, 41(5), 2472–2483.
- [15] Mark, E. Z., (1984). Methodological Issues Related to the Estimation of Financial Distress Prediction Models. *Journal of Accounting Research*, 22, 59-82.
- [16] Martin, D., (1977). Early warning of bank failure: A logit regression approach. *Journal of Banking & Finance*, 1(3), 249-276.
- [17] Ohlson, J. A., (1980). Financial ratios and the probabilistic prediction of bankruptcy. *Journal of Accounting Research*, New York: 18(1), 109 - 131.
- [18] Ross, S.A., Westerfield, R.W., Jaffe, J.F., (2002). *Corporate finance* (6th ed). McGraw-Hill Irwin.
- [19] Tam, K. Y., Kiang, M. Y., (1992). Managerial applications of neural networks: The case of bank failure predictions. *Management Science*, 38(7), 926 -947
- [20] Ugurlu, M., and Aksoy, H., (2006). Prediction of corporate financial distress in an emerging market: the case of Turkey. *Cross Cultural Management: An International Journal*, 13(4), 277-295.

# Social Enterprise in Vietnam – Opportunities, Challenges and Solutions

Le Ngoc Dang \*

Lecturer in International Finance, Academy of Finance, No 1, Le Van Hien street, Duc Thang Ward, Tu Liem North District, Hanoi

## ABSTRACT

Social enterprise has been believed as a social innovator through applying innovative entrepreneurial spirit to achieve its priority of solving social issues, that is the challenge in the process of economic development of a nation. In Vietnam, although this type of business has only been officially recognized since 2014, social enterprise is expected to develop at a fast pace and contribute significantly to the community in the next few years. In this paper, the necessity of encouraging social enterprise's development is firstly presented to illustrate its values to the society. Then, opportunities and challenges for existing and developing social firms are going to be assessed by using secondary data collected and analysed in the context of Vietnamese business environment. Despite the fact that social entrepreneurship has to face significant constraints due to the nature of the business as well as lacking support from authorities, there is a wide range of opportunities the social innovator can grasp. A group of solutions toward distinct involving bodies namely government, entrepreneur and university is also suggested in order to make social enterprise system in Vietnam broadening and thriving.

**Keywords:** social enterprise, social entrepreneur, Vietnamese business environment.

## 1. Introduction

Despite the fact that social entrepreneurship has its long history in developed nations, it is still a new concept in Vietnam. The high growth rate of economic development cannot ensure sustainability for the community, even in some points, economic growth has resulted in social issues such as widening the gap between the poor and rich or environmental pollution. Moreover, becoming a middle income - country means Vietnam has to experience a significant cutting of ODA loans with preferred conditions and withdrawal of NGOs. Loans and aid from those donors have played an important role in solving social problems in Vietnam before. Thus, in condition of insufficient state budget, finding alternative financial resources is crucial in order to achieve the goal of being a sustainable economy that the Vietnamese government is pursuing. In this circumstance, developing social enterprises whose primary purpose of dealing with social problems by using business approaches seems to be one of the best solutions. This paper is going to evaluate the advantages as well as the difficulties in developing social entrepreneurship in Vietnam. After that, solutions to seize the opportunities and combat challenges are suggested.

## 2. Concept of social enterprise and social enterprise in Vietnam

The term "social enterprise" (SE) was recognized in the late twentieth century. However, there has not been a universal definition of social enterprise. Some common definitions are widely used as below.

- According to the EMES European Network for social enterprise (2008), social enterprise is an organization with clear goals of benefiting the community, founded by a group of citizens and the degree of interest in the physical profit of investors is not much.
- The Organization for Economic Co-operation and Development (OECD, 2004) develops its own definition of social enterprise, based on the diversity of social enterprises in its member countries: social enterprises are

\* Corresponding author. Tel.: +84963074488.  
E-mail address: dangngoc88@gmail.com

organized in different legal forms in OECD countries to pursue economic and social objectives with a business spirit and nine social and economic criteria.

In general, the main purpose of social enterprises is dealing with social problems through business activities; Social enterprises exist for the goal of helping those who are disadvantaged in the economy or tackling the issues arising from economic development.

The term 'social enterprise' is recently imported to Vietnam, only gaining official recognition by Vietnamese government since 2014 when enterprise law came into effect. Today, above 200 firms are considered as social enterprises in the country.

According to Vietnam's Parliament (2014), social enterprises are business bodies with their philosophy of addressing social issues and environment as well as benefiting the community; In addition, this type of business must use at least 51% of total annual profit for reinvestment to achieve social and environmental goals as registered.

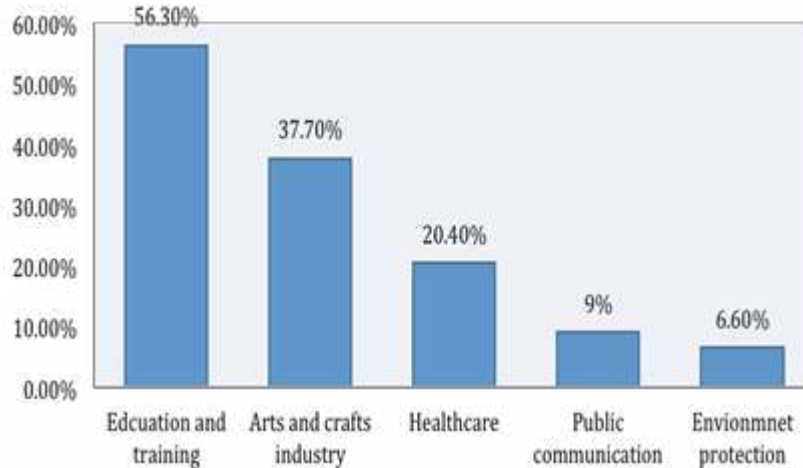

*Fig. 1. Social enterprises' sectors in Vietnam*

Source: BC, 2014

A research from British council Vietnam (2014) indicates that five major fields that social enterprises in Vietnam focusing on are education, art, healthcare, public communication and environment. Among them, education and training sector ranked first with 56.3%, followed by arts and crafts industry (37.7%) and health care system (20.4%). (**Fig. 1**)

### **3. The necessity of encouraging social enterprises to develop in Vietnam**

#### **3.1. Firstly, due to values that social entrepreneurship brings for society**

The priority of social enterprises is to solve social and environmental problems rather than purely making profit. This type of business is necessary for all countries, especially developing and underdeveloped ones where a large number of social problems associated with rapid economic growth exists and emerges. However, since the lack of financial resources, those social issues have been tackling ineffectively.

In Vietnam, the government has insufficient fund to address social problems. The World Bank (2013) reported that although Vietnam has made significant progress in the area of poverty reduction when poverty rates have dropped from 60% to 20.7% in 20 years, a rate of 20.7% of the population remains high.

In addition, social entrepreneurship is seen as an innovative start-up for young entrepreneurs with innovative business ideas that come with solving social problems. In Vietnam, the encouragement of this kind of start-up not only reduces the burden on the state budget for social issue, it also contributes to solve unemployment especially for disadvantaged people who are difficult to find a job.

#### **3.2. Secondly, social enterprise may replace the roles of NGO and humanitarian aid in coping with social issues in Vietnam**

A significant reduction in external aid such as ODA or the withdrawal of donating activities by NGOs and international humanitarian organizations when Vietnam officially became a middle - income country, has created additional fiscal pressure for the government to continue and develop budget for addressing social issues. Previously, NGOs and humanitarian aid agencies have been important resources in finding and dealing with social problems. Therefore, if having a cut on financial aid, alternative resource is required.

According to Ministry of Finance, Vietnam (2016), it is expected that by July 2017, Vietnam will no longer be entitled to non - refundable loans under ODA, only preferential loans and market condition loans are applicable. Furthermore, ODA loans have as fast or raised interest rates by 2% -3.5%.

However, according to British council (2014), a decrease in the number of NGOs can be replaced by social enterprises that are able to handle and continue the work of NGOs. A social firm can even solve social issue in better way as its advantages:

- In comparison to NGOs, social enterprises do not rely heavily on donors. The biggest limitation of NGOs in carrying out their mission is the overwhelming dependence on supporters that lead to the lack of initiative and inefficiency for combating social issues (Islam, 2016). In contrast, by using business approach, social enterprises seek to optimize economic efficiency as much as possible. Moreover, since SE's beneficiaries are also their employees or customers, there is a direct connection between them and the founders as entrepreneurs. Social enterprises are self-responsible in business monitoring with minimizing cost purpose. Thus, social enterprises help to fundamentally improve the independence, autonomy and sustainability of the organization as well as its social solutions. The greater the income from business activities, the better the social enterprises have position in relation to donors.
- SE's assistance to beneficiaries is sustainable approach whilst NGOs often benefit beneficiaries in 'one way', 'free' solution which thus creates the habit of 'dependence' of receivers. The "helping" methods of NGOs often do not encourage self-motivation to assist receivers to escape the beneficiary situation. For example, a common case in many poverty reduction projects in Vietnam is that most buffaloes, cows, goats are ill or dead shortly after handover because the projects are not fully equipped including knowledge and technique to feed or take care the farm animals (Thao, 2017). Therefore, it is crucial to equip the knowledge to improve the capacity of financial management, risk management, investment selection, market demand, market connection, etc. for the poor prior to handing over. Giving fish or fishing rods for beneficiaries are struggling matter for almost all of NGOs. On the contrary, the approach of social enterprises always aims at a better sustainable solution. Beneficiaries are trained to get a job or continue to develop their project in long term after the assistance finished. Take KOTO for example, it is the first social enterprise recognized in Vietnam, learners (beneficiaries) of this firm are expected to graduated after two years of training, then they might be awarded a valuable certificate from the Box Hill of Australia that helps them to be eligible for working in five star hotels and restaurants around the world (Webometrics (2017) show Box Hill is one of the top 40 TAFE schools in Australia). In fact, a large numbers of chefs, restaurant staffs of five star hotels in Vietnam are now KOTO students.

#### **4. Opportunities and challenges for development of social enterprise in Vietnam**

##### **4.1. Opportunities**

###### **Huge potential to develop**

Although Vietnam has made significant effort in economic growth with high growth rates and a declining rate in the proportion of the poor, there are still a lot of social problems, such as increasing wealth gap, high unemployment rate especially for the handicapped and other disadvantaged people. People living with HIV / AIDS, termination of prison, elderly people also need help. Especially, the problem of environmental pollution poses major challenges for finding solution including financial resources to handle it. All above leave room for social entrepreneurs with innovative business ideas.

According to the Global Entrepreneurship Monitor (GEM, 2015) report, in 2015, Vietnam had 1.12% of adults starting their careers and participating in social activities, in which the start-up rate of social enterprises in 2015 is only 0.45%. The proportion of adults who are leading and managing social activities in Vietnam is 0.65% compared to 3.7% in the world. This shows that although possessing huge potentials for start up in social field, social entrepreneurship in Vietnam are still underdeveloped.

###### **Entrepreneurship, start-up spirit are widely spreading among the youth with positive attitudes to a better community**

Vietnam has over 80,000 registered enterprises annually. Although the total number of Vietnamese enterprises is relatively low but growth rate is remarkably high. Today, the spirit of start up among young generation is stronger and apparent than before with more innovative business ideas. According to Amway group in "Entrepreneurship in a changing work environment" report (2016), Vietnam is leading in entrepreneurial spirit index, followed by India and Thailand among 45 countries surveyed (Fig. 2).

In addition, it is clearly seen the increasing number of students who intern, volunteer and work for NGOs and social enterprises recently, that phenomenon was hardly seen in 10 years ago. Today students are free to access foreign information, possess better foreign language skill, actively participate in seminars, events, clubs. They are eager to update modern, trending knowledge of the world including social innovative. This is definitely the source of

"community leaders" for social enterprises in the future.

**Large potential in external support for social enterprises**

There are various types of support such as capital, technology or competent assistance. In general, they are available and abundant both in domestic and external. For attracting social investment from foreign organizations, the essential factor depends on capacity and prestige of domestic social enterprises. In fact, several social enterprises in Vietnam have been successful in attracting and managing international capital, especially HoaSua School and KOTO Restaurant.

For domestic resource, Vietnamese government in early 2017 has made concrete steps in supporting small and medium enterprises including social enterprise through underlying assistances namely access to credit via credit guarantee funds for small and medium-sized businesses, tax support, technology support, market support, information and legal support or and human resources development support.

In addition, the existing of organization promoting social enterprises like CSIP also has important impact on assisting social enterprises. Established in 2008, CSIP seeks and directly support for entrepreneurs and social entrepreneurs who are adopting sustainable business solutions to address social and environmental challenges. CSIP works with stakeholders to raise awareness of social entrepreneurship, build national and international networks, and promote the creation of a more enabling environment for Vietnamese social enterprises.





**Fig. 2. Amway entrepreneurial spirit index 2016**

Source: Amway (2016)

**Questions for survey:** If you think of yourself, do you agree with the following statements (based on the theory of planned behaviour; consistency of attitudes, social norms and perceived behaviour control)?

**ANSWERS:**

 I consider starting a business as a desirable career opportunity for myself (desire).

 I possess the necessary skills and resources for starting a business (feasibility).

 My family or friends could never dissuade me from starting a business (stability against social pressure).

**4.2. Constrains and challenges for social entrepreneurship in Vietnam**

**The inadequate awareness of social enterprise’s position and role in Vietnam, that has created difficulties in social enterprises’ operating**

Because social enterprise is a new concept in Vietnam, even in the business community, the number of people who fully understand social entrepreneurship is still limited. Pham (2016) argued that awareness of the role of social enterprises and social activities is weak. She also affirmed that Vietnam now has more than 1,000 social enterprises, but they do not know how to organize their enterprises as social enterprises. Since 2014, when the Enterprise Law was taken into effect, only about 10 social enterprises registered under this law.

Social enterprises are often misunderstood and skeptical about social objectives when operating in the form of

entrepreneurship, which are a barrier for social enterprises to work with stakeholders and lead to increase the cost of time that limit abilities and opportunities to create positive and sustainable impact.

#### **Difficulties in accessing financial resource and other types of support**

Vietnamese social enterprises are young, immature and formed mainly from personal ideas. Therefore, the initial investment for social project is small investment amount. According to British council (2014), on the average, each social enterprise has equity (owner's capital) accounted for 20.3%, capital accumulated from production and business activities 45.5%, financial support 5.3%, other sources of capital (bank loans, family friends) accounted for 28.8%. Meanwhile, regulations on non-commercial grant recipients are unclear. Capital constraints are having a significant impact on the existence and development of social enterprises.

In fact, there are different kinds of capital as well as technique support that social enterprises can access. They come from institutional investors, venture capital funds, and non-governmental organizations. Each of these sources of investment can assist businesses from start-up to accelerated replication or only in a period of time in any business phase. However, the donors' approval process is quite strict and requires experience and qualifications of the social enterprise's founders in terms of the ability to provide an effective solution to maintain the long-term development. Founding members must also demonstrate the methods that businesses will generate money, and how the business can develop 10 times in size. Therefore, with the weakness of experience, professionalism in business operating and development strategy planning, accessing to these supports is a crucial challenge for Vietnam's young social entrepreneurs.

#### **Human resource's constraint**

Social enterprises have to compete equally with other normal firms in the market while a lot of them employ disadvantaged employees or disabilities. That is why human resource in social enterprises is often unqualified with low level of education. In some cases, they are unhealthy and usually need to have less constant work as well an extra time to relax. This issue increases the labour cost in doing business and make social enterprises less competitive compared to other rivals.

#### **Inadequate corporate managing competence**

Managing a social business successfully is a highly challenging task because social entrepreneurs must satisfy both of objectives including profit and social benefits. On the other hand, in Vietnam, there are a limited number of programs that officially equip the knowledge and skills needed by social entrepreneurs. This leads them to have to self-study during running the business.

According to Smith (2014) unprofessional and ineffective business management is one of the most weaknesses of social enterprise in Vietnam. Skills include business planning skill, accounting skill or social impact measurement. Smith also provided several typical examples in his study to reinforce his argument, such as CCHCPS – a Vietnamese social firm that provides health care and support to people living with HIV/AIDS, drug addicts and sex workers in Haiphong, acknowledged that they needed support in designing a business model that could start to effectively cover their costs. Another examples is Truong Sanh enterprise, it found difficulties in establishing marketing channels for its traditional medicines in southern Vietnam. Another case is Safe Living Company, it complained of difficulties in producing financial reports for the tax authorities.

#### **Risk in existence and development of a social enterprise in the long run due to board of directors' conflict**

In fact, a variety of social enterprises encounter inconsistency among shareholder group about reinvesting profits for social purposes and organizational development. In the early stage of starting a business, due to lack of capital, social enterprises often have to borrow family and friends. They may be "mind-centered" investors, but most do not yet understand deeply the social enterprises model, so it is difficult to connect with the social mission in the long run. In other words, they are still traditional investors, not social investors, so the risk of derailing social enterprises at a later stage is very high.

## **5. Recommendation to encourage social enterprises in Vietnam**

### **5.1. For Vietnamese government**

Regarding access to finance from small and medium business support funds, the Government should provide detailed circulars, guidelines on financing standards, forms and modalities, as well as loan processing cycles for social enterprise owners. This is to help social enterprises better understand about requirement and have careful preparation for accessing to preferred credit. In addition, forms of financial incentives such as tax reductions should also be guided clearly in detail.

The government should establish or encourage the establishment of social enterprise - support organizations that are similar to SPARK or CSIP format, which has been operating effectively in Vietnam. These are the important bodies in supporting social enterprises, especially the start-up social entrepreneurship via technical support, human resource training or seminars, meeting to share experience by the social entrepreneurs.

The government should have a supportive policy to encourage universities to more involve in social enterprise's development. Every year, state budget for education should invest in establishing start-up models within the university



environment by improving research and innovation; promote importing social entrepreneur subjects to curriculum not only in economics universities, but also in technology and science schools/colleges.

The government should promote the image of outstanding social enterprises that successfully run business to achieve social goals through awards' ceremonies and promotion strategy in media. This, on one hand, attracts attention of public to a new type of business, on the other hand, encourages social entrepreneur for better performance.

**5.2. For social enterprises**

The effectiveness of social enterprises mainly depends on how the enterprise is managed. Therefore, the competence of founders is still the most decisive factor affecting social enterprise's success. In order to exist, develop and compete in market, social enterprises' owners should:

- Have creative business plan and it is feasible. A social entrepreneur should be a social innovator when business ideas are created in different, innovative ways by applying new ideas, new model and strategy to fill the gap of the market, meet social need or solve social issues that untapped by anyone. However, this business idea needs to be feasible, achievable and carefully planned.
- Expanding valuable networking with domestic and international donors to increase the chance of being financed to grow the business, achieve social target. The firms should organize fundraising events to attract sponsors in domestic as well as external markets.
- Proactively fostering business management (self learning, learning from experience, learning from books, learning from school). Lack of skillful managerial staff has been noted as a barrier of development of social enterprises. It is important for social enterprises to have a robust management system with strong governance structures.

**5.3. For education system**

The university should be an important source of entrepreneurship and innovation in society. This is a place to support, connect resources so that business ideas in the students can be nurtured. Universities therefore need to be more effectively involved in the start-up social enterprise process. In Vietnam, some universities have applied this model, such as Hanoi Polytechnic University and Ho Chi Minh City University of Technology but those projects are still in limited size.

According to entrepreneurial Eco – system report (GEM, 2015), the rating of education for entrepreneurship in education system in Vietnam is alarming low. The rating for entrepreneurship education at school and entrepreneurship education at post school are only 2.47 and 4.17 relatively, ranked 47th among 62 participating countries, which illustrates highly insufficient in entrepreneurship educating in education system in Vietnam in all stages (Fig. 3).

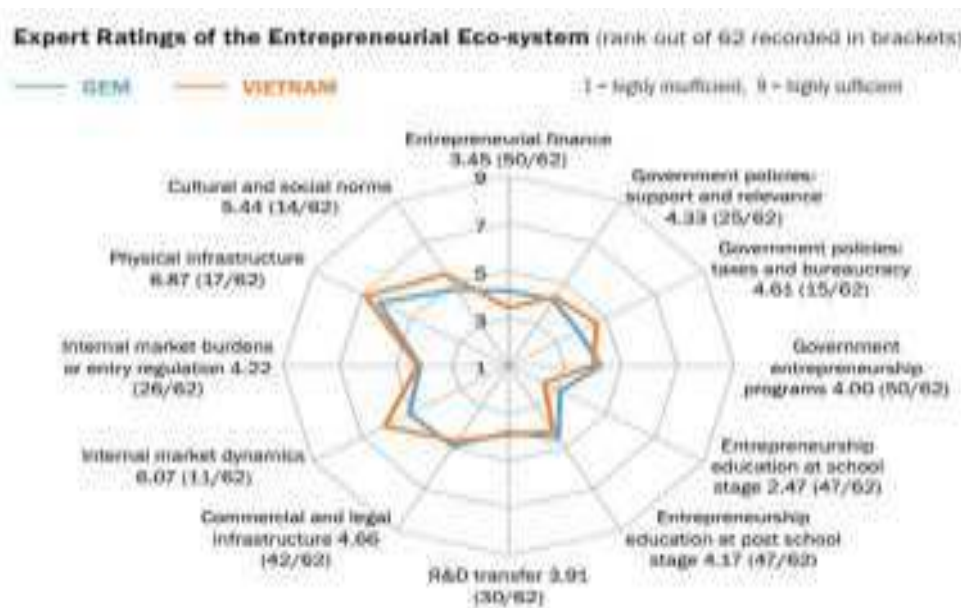

**Fig. 3. Entrepreneurial Eco – system among group of 62 countries**

Source: GEM, 2015

Therefore, in order to successfully carry out mission in terms of identifying, nurturing and training potential, talent social innovators, the universities should implement these strategies:

- Embedding social entrepreneurship and innovation into circular; deploying model of social enterprise in universities and widespread knowledge about social entrepreneurship.
- Learning experience from foreign universities and organization that have implementing excellent programs of incubating startup businesses in schools (Singapore or Australia for example). Universities should hold innovative business ideas contests to by that way to figure out talent and potential individuals, to nurture the seeds of social entrepreneurship.
- Emphasizing on entrepreneurship skill in curriculum. The skills include communication and negotiation skills, team building skills, problem-solving skills; crisis management skills, leadership skills and strategic thinking; Rather than teaching only theory, universities need to switch to learn through experience, that helps young learners more excited and easier to understand abstract knowledge.
- Redefining university capacity profiles by making a stronger commitment to the business in general and the start-ups in particular through engagement with policy makers and business circles. That connection firstly benefits the university, as it justifies the essential meaning of the university; then enhances the prestige of the school in society, turning the school into an indispensable element in national innovation system.

## 6. Conclusion

In comparison to normal type of business, social enterprises have outstanding values for community when they primarily focus on tacking social issues rather than maximizing profit for owners. In Vietnam, huge potentials to develop SE basing on the encouragement of government by providing favorable conditions or widely spreading start up spirit over the country. However, there has a large number of challenges that social entrepreneurs facing namely the difficulty in accessing financial resource, inexperienced and ineffective managing competence or human resource's constraint. In order to survive and develop social enterprise, besides solutions for founders as improving organization managing skill, broaden donor networking, the government and education system should share responsibility in term of giving more assistance to SE (financial assistance, human resource assistance) or paying attention on training social entrepreneurship in university system not only theoretically but also practically.

## References

- [1] Amway group. (2016). Entrepreneurship in a changing work environment. Retrieved from [http://globalnewsassets.amway.com/501484/ager\\_2016\\_publication.pdf?r=1600](http://globalnewsassets.amway.com/501484/ager_2016_publication.pdf?r=1600)
- [2] British council. (2014). Social enterprise in Vietnam - concept, context and policy. Retrieved from <https://www.britishcouncil.vn/sites/default/files/dnxh-tai-viet-nam-khai-niem-boi-can-hinh-chinh-sach.pdf>
- [3] EMES. (2008). The EMES approach of social enterprise in a comparative perspective. Retrieved from [http://emes.net/content/uploads/publications/EMES-WP-12-03\\_Defourny-Nyssens.pdf](http://emes.net/content/uploads/publications/EMES-WP-12-03_Defourny-Nyssens.pdf)
- [4] GEM. (2015). Global Entrepreneurship Monitor 2015. Retrieved from <http://gemconsortium.org/report>
- [5] Islam, C. (2016). Non-Governmental Organization Vulnerabilities: Donors and Resource Dependence. Retrieved from [http://scholarship.claremont.edu/cgi/viewcontent.cgi?article=2367&context=cmc\\_theses](http://scholarship.claremont.edu/cgi/viewcontent.cgi?article=2367&context=cmc_theses)
- [6] MOF. (2017). *MoF outlines Gov't loan re-lending* - Economy - Vietnam News | Politics, Business, Economy, Society, Life, Sports - VietNam News. Retrieved from <http://vietnamnews.vn/economy/377616/mof-outlines-govt-loan-re-lending.html#ZqEehIrmBDQD5AP7.97>
- [7] OECD. (2004). The social enterprise sector: a conceptual framework. Retrieved from <http://www.oecd.org/regional/leed/37753595.pdf>
- [8] Pham, T. (2016). Necessity to understand about social enterprise. Retrieved from <http://www.doanhnhansaigon.vn/khoi-nghiep/can-hieu-dung-ve-doanh-nghiep-xa-hoi/1100328/>
- [9] Smith, W. (2014). Social enterprise: constraints and opportunities – evidence from Vietnam and Kenya. Retrieved from <http://spark.org.vn/wp-content/uploads/2010/08/Social-Enterprise-constraints-and-opportunities-evidence-from-vietnam-and-kenya.pdf>
- [10] Thao, C. (2017). Support to push internal force, not for endless distribution. Retrieved from <http://langmoi.vn/ho-tro-thuc-day-tu-noi-luc-chu-khong-ban-phat-vo-tan/>
- [11] The World Bank. (2013). Poverty Reduction in Vietnam: Remarkable Progress, Emerging Challenges. Retrieved from <http://www.worldbank.org/en/news/feature/2013/01/24/poverty-reduction-in-vietnam-remarkable-progress-emerg>
- [12] Vietnamese Parliament. (2014). Enterprise Law 2014. Retrieved from <http://www.vnep.org.vn/Upload/Luat%20Doanh%20nghiep%202014.pdf>
- [13] Webometrics. (2017). Australia | Ranking Web of Universities. Retrieved from <http://www.webometrics.info/en/oceania/australia>

International Conference For Young Researchers In Economics And Business, ICYREB 2017, October 30<sup>th</sup> 2017  
Da Nang, Vietnam

# Crowding Out Effects of Public Spending on Private Investment – An Evidence from Vietnam

Le Viet An\*

Faculty of Finance – Banking and Business Management, Quy Nhon University, 170 An Duong Vuong, Quy Nhon City, Binh Dinh province, 820000, Vietnam

## ABSTRACT

This study's principal objective is to investigate the effect of public budget spending on private investment in Vietnam. The dynamic panel data from 63 provinces which are assembled from Vietnamese General statistics office, adding several indicators which are obtained from World Bank database over the period 2006-2014 are analyzed by the one-step difference GMM. We research both overall government budget spending and its classifications, including expenditure on development investment and current. As a result, we explore that there is not only non-existence of crowding out effect of total state budget and development investment expenditure but also supportive effect of current expenditure on private capital. Concurrently, the positive connection between current expenditure and investment in private sector is affected by macroeconomic stability and quality of the institution. The one-lagged private capital, moreover, is examined to have the same changeable trend with private investment whereas the growth of local economy and institutional quality are the major barriers to investment decisions made by private enterprises. The latter are related to competitive pressures and unfavorable business conditions that businesses are reluctant to invest.

**Keywords:** Crowding out; private investment; public spending; GMM

## 1. Introduction

Public spending, which has always been highly appreciated due to its significant role, not only be one of the basic indirect inputs of economic growth but also make indirect influence through transition effect on other macroeconomic factors of which private capital is among. The issue attracts many debates is that the link between government expenditure and private investment is positive or negative. In other words, whether the crowding out phenomenon appears.

Some authors have persisted this is natural because of higher state expenditure, on the one hand, rises demand for goods and services, leading to an interest rate increase; On the other hand, the government must raise taxes to have enough fund for expenditure. These factors make a competition between public and private sector for approaching capital source and the benefits often incline the former sector. They consequently cause a decline in investors' demand, causing an equivalent fall consumption and investment in private sector (Argimon et al., 1997, Ahmed and Miller, 1999, Cavallo and Daude, 2011, To Trung Thanh, 2011). The economists call this phenomenon crowding out effect. Yet, some other studies have proved the opposite. In fact, public expenditure, especially on infrastructure such as roads, bridges, airports, etc. creates an advantageous business environment, becoming an attractive channel for attracting investment (Aschauer, 1989; Gjini and Kukeli, 2012). In addition, it also helps increase the marginal productivity of capital, bringing private capital into the economy more and more (Aschauer, 1989; Gjini and Kukeli, 2012). The tendency which is opposite crowding out like that is called crowding in.

In Vietnam, public spending rose with relatively high speed, about 20% per year over the period 2005-2014. The matter is that government expenditure frequently had an ICOR of over 8.2, which reflected the low efficiency of capital while domestic private investment was approximately 3.5. Next, many private enterprises complained about the apparent preference for State-Owned Enterprises in accessing production sources. Furthermore, there was a deficit in both quantity and quality of public spending on transport and communication infrastructure, training human resource,

\* Tel.: +84 982211817.

E-mail address: levietan@qnu.edu.vn

etc. in order to form an attractive investment environment. In other words, government investment did not really complement private one. Those also provide the evidence of crowding out effect. Therefore, in the process of economic restructuring, it is crucial to assess the relationship between government spending and private investment, thereby affecting economic growth.

Moreover, most of Vietnamese researchers have cared for crowding out in terms of overall public spending, along with my knowledge. This gives us a general view about crowding out or in, but it is difficult to specifically examine the impact of the components of government expenditure on private investment. This paper aims to handle those problems by examining all kinds of state spending. Besides, the one-step difference GMM is employed to estimate the model where there is attendance of the lagged variable, dissimilar to other Vietnamese writers, such as VECM of To Trung Thanh (2011), SVAR of Su Dinh Thanh (2011). In addition, we add dynamic panel data which is collected from all 63 provinces in Vietnam compared with time-series data in outstanding studies about crowding out in Vietnam of Su Dinh Thanh (2011), To Trung Thanh (2011). This approach is expected to bring new comments about crowding out.

The rest of the paper is structured as follows: Section 2 presents literature review on crowding out effects. Section 3 mentions method and research data before results are revealed in Section 4. Lastly, Section 5 shows conclusions.

## 2. Literature review

From the point of total state budget expenditure, many studies concur with the crowding out on private investment (Argimon et al., 1997, Cavallo and Daude, 2011; Furceri and Sousa, 2011; To Trung Thanh, 2011). For instance, Cavallo and Daude (2011) saw the clear negative impact of public spending on the level of private investment. In the short run, one percentage point increase in the proportion of public investment to GDP reduced the share of private investment by 0.22 percentage points. The long-term response was 67% of the decrease in the ratio of private investment to GDP. This conclusion shared the same view with Furceri and Sousa (2011) who realized that each increase in government expenditure by 1% of real GDP declined 0.6% of private investment. Narrowing to Vietnam scope, To Trung Thanh (2011) found the time when this external impact reached maximum is in the 5<sup>th</sup> year with Vietnamese data for the period 1986-2010.

Meanwhile, other economists argued that public spending was a boost to investment through contributing to enhance the marginal productivity private capital (Aschauer, 1989; Gjini and Kukeli, 2012). In support of this argument, Su Dinh Thanh (2011) suggested that public investment could create positive externalities with FDI in short-run and with private investment in long-run when analyzing Vietnamese data. Similarly, Dao Thi Bich Thuy (2014) proved that the crowding out was much more than crowding in. Consequently, government spending had a positive effect, being a driving force for economic growth in ASEAN-5, including Vietnam.

Several other studies produce diverse results about crowding out, depending on geographical location or level of economic growth. Ghura and Goodwin (2000), with data from 31 developing countries for the period 1975-1992, confirmed that government investment was in support of private investment. They concurrently indicated capital in private sector in developing nations in Asia and Latin America were discouraged by public spending like remaining regions. Likewise, Furceri and Sousa (2011) found the evidence of stimulation of government expenditure on private consumption and investment in the Middle East whilst the other areas including OECD group and developing countries showed reverse effect. With similar aim, Afonso and St Aubyn (2009) gave some exciting findings when exploring both crowding in and out. They looked for clues in a list of developed countries in Europe, North America, and East Asia over 45 years. The result confirmed that the inspiring influence was more popular when occurring in 2/3 countries in sample. Expanding to 31 nations by adding some developing countries, experimental investigation of Erden and Holcombe (2005) suggested that the average of 10% growth in public investment was related to 2% increase in private investment. More detail, government spending facilitated private spending in developing countries whereas the crowding out appeared in developed countries.

However, those results were by no commons for the context of 11 East Europe nations in the period 1991-2009. Gjini and Kukeli (2012) showed the comment that there was no crowding out. Although distinguishing objectives in sample according to the level of economic growth, they just found the positive marginal effect of government expenditure on private investment.

When dividing state spending into expense on productive services (e.g., building infrastructure) and unproductive services (consumption), crowding in is inclined to the former. Indeed, as mentioned above, most authors were aware of the beneficial role of providing good infrastructure by public sector. It gained private capital productivity, profit, encouraging investment. Hence, this led to a meaningful conclusion that public investment, once again, became a motivation for private investment (Aschauer, 1989, Blejer and Khan, 1984, Ahmed and Miller, 2000). In other words, there is no crowding out for expenditure which is related to expenditure on development investment.

Further detail about unproductive spending, Ahmed and Miller (2000) pointed out that, except consumption for transport and communications, other expenditures had negative connection with the private investment, such as expenses for defense, education, health, social security and welfare, economic services and activities, and others. At the same time, they also found the crowding out when classifying expenditures to tax-financed and debt financed.

However, some studies indicated that crowding out or in effects between these two factors disappeared as many

economists mentioned before. They even found no significant connection between public investment in transport and communications and private investment (Easterly and Rebelo, 1993).

### 3. Methodology

#### 3.1. Research model

Based on studies of Aschauer (1989), Cavallo and Daude (2011) about crowding out, two regression models are proposed for Vietnamese status as follows:

Model 1:

$$\text{PriC}_{it} = a_1 \text{PriC}_{it-1} + a_2 \text{PubC}_{it} + a_3 X_{it} + a_4 \text{Ma}_{it} + a_5 \text{FD}_{it} + a_6 \text{Ins}_{it} + a_7 [\text{PubC} * \text{Ma}]_{it} + a_8 [\text{PubC} * \text{FD}]_{it} + a_9 [\text{PubC} * \text{Ins}]_{it} + \varepsilon_{it}$$

Model 2:

$$\text{PriC}_{it} = b_1 \text{PriC}_{it-1} + b_2 \text{DE}_{it} + b_3 \text{CE}_{it} + b_4 X_{it} + b_5 \text{Ma}_{it} + b_6 \text{FD}_{it} + b_7 \text{Ins}_{it} + b_8 [\text{DE} * \text{Ma}]_{it} + b_9 [\text{DE} * \text{FD}]_{it} + b_{10} [\text{DE} * \text{Ins}]_{it} + b_{11} [\text{CE} * \text{Ma}]_{it} + b_{12} [\text{CE} * \text{FD}]_{it} + b_{13} [\text{CE} * \text{Ins}]_{it} + \theta_{it}$$

Public expenditure is approached in two directions: aggregate state budget spending and its components which are classified by the Ministry of Vietnamese Finance. Hence, crowding out effects of private investment by public spending are illustrated in both of above models, in which model 1 evaluate the impact of total state expenditure (PubC variable) whereas model 2 is modified to reflect each composition of the government budget, including development investment (DI) expenditure (DE variable), and current expenditure (CE variable).

The dependent variable (PriC) concerns the investment capital of private sector, being calculated by the rate of private investment to GDP for each province. This calculation which can directly assess changes in investment due to different elements occurred in Ahmed and Miller (2000), Carrasco (1998), Cavallo and Daude (2011).

The main independent variable is total budget consumption (in model 1), development investment expenditure, and current expenditure (in model 2), determined as the percentage of each value of GDP (Khan and Kumar, 1997; Ahmed and Miller, 2000; Cavallo and Daude, 2011). Those independent variables are the same chosen with several foreign authors. Namely, from the view of choosing research model, private investment in many models about crowding out directly played a dependent variable (Ahmed and Miller, 2000; Carrasco, 1998; Cavallo and Daude, 2011; Gjini and Kukeli, 2012). Unlikely, in other studies (Bahal et al., 2015; Khan and Kumar, 1997), it was considered as an independent variable in equations where output growth was a dependent variable, which was also applied in many Vietnamese researches (Dao Thi Bich Thuy, 2014; To Trung Thanh, 2011). About impact trend of those variables – state budget and its parts – as discussed earlier, have diverse influence on investment of private sector, that is crowding in, crowding out, or even no effect.

The other proxies which are for investigating macro factors affecting private capital consist of macroeconomic stability, financial development, and institutional quality. Firstly, Ma variable represents stability of macroeconomic environment, and in this study, output growth (Gdpg), inflation rate (Inf), and exchange rate (Exch) are used as main indicators of the macroeconomy. Namely, it is denied that private investment is always stimulated by economic growth because the connection of them is certainty (Ghura and Goodwin, 2000; Erden and Holcombe, 2005). When the economy develops, obviously, bringing larger market; promoting conditions which create attractive investment environment such as technology, infrastructure, human force quality, etc.; raising savings which become investment capital in the future. So, it contributes to the investment increasing. Another determinant is inflation which is often considered as a negative factor for two major reasons: (1) inputs prices rise, leading to an upturn in production costs, making a downward trend in investment; (2) goods prices enhance, decreasing demand and of course, affecting size of production (Carassco, 1998; Gjini and Kukeli, 2012). Although it is, in certain level, a prices escalation boosts revenues, stimulating investment (Carassco, 1998; Ghura and Goodwin, 2000). Also, firm activities are influenced by exchange rate, that change the prices of import inputs, export goods and services as well. The impact of exchange rate on the investment decisions, so, is ambiguous due to its both positive and negative impact on enterprise revenues and costs (Ghura and Goodwin, 2000; Erden and Holcombe, 2005; Cavallo and Daude, 2011). Relating how to measure them, output growth and inflation rate is respectively determined by the growth of province's real GDP (Erden and Holcombe, 2005) and of consuming price index (Gjini and Kukeli, 2012); exchange rate is identified by natural log official exchange rate (VND/US\$, period average) (Ghura and Goodwin, 2000; Erden and Holcombe, 2005).

Next, the level of financial development in Vietnam is evaluated on the ground of many studies conducted by Demircuc-Kunt and Levine (1999), Levine (2002). Financial development (FD) is a conglomerate measure of financial structure based on activity, size, and efficiency of stock markets relative to that of banks. They are respectively calculated by the logarithm of the total value traded ratio times the private credit ratio, of the market capitalization ratio times the private credit ratio, and of the total value traded ratio divided by costs per capita. After that, the logarithm of the average value of three above indicators is used to reflect FD.

Coming proxy is institutional quality which plays an extremely essential role in economic activities. The crowding out effect can be present in the periods and regions which have less developed institution, reduce and go supportive when the institution becomes better (Everhart and Sumlinski, 2001). The quality of institution (Ins variable), in this paper, is defined by Government Indicators supplied by World Bank (WB) and be the average value of six indicators (Control of Corruption, Government Effectiveness, Political Stability and Absence of Violence/Terrorism, Regulatory Quality, Rule of Law, Voice and Accountability). The similar assessments were found in Givens (2010), Anyanwu (2012), Belkhir et al. (2016).

Lastly,  $X_a$  is a group of the control variables, which include foreign direct investment (Fdi), labour force (Lab), and the sum of exports and imports revenue (EI), are predicted to have impacts on private capital. Indeed, along with domestic capital, FDI over the last two decades has been appreciated as a “foreign push” for investment as well as a positive external source for economic growth in Vietnam. There has been considerably debated about whether FDI creates spillovers for private domestic capital and the answers are various (Adams, 2009; Ameer et al., 2017; Agosin and Machado, 2005). Additionally, labour force is one of the crucial inputs of production, so its enlargement which has the linkage with firm size contributes to raising the amount of investment (Ghura and Goodwin, 2000). Another factor relates openness. Thanks to exports and imports, Vietnamese enterprises can approach foreign markets, exploit both materials and large markets. As a consequence, a boost in foreign trade can increase private investment (Ghura and Goodwin, 2000; Ahmed and Miller, 2000). FDI and the overall of exports and imports revenue are determined as a percentage of each value to GDP, and labour force variable is calculated by the growth ratio of labour force.

### 3.2. Research method

It is noticeable that the one-lagged private capital  $PriC$  ( $PriCt-1$ ) will be added to the model as an independent variable. Thus, this is dynamic panel data regression model in theoretical background terms. Some violations from this kind of model can occur such as (1)  $PriC$  variable goes endogenous due to the correlation between the one-lagged private capital  $PriC$  ( $PriCt-1$ ) and the residual in model; (2) The one-lagged variable of dependent variable brings the one-level autocorrelation in two models; (3) Local characteristics which do not change over time (e.g., geographic, demographic, etc.) can be correlated with explanatory variables, so, this presents the existence of fixed effect in models' residual; (4) Research data has short time ( $T = 9$ ) and large scope of space ( $N = 63$ ).

To remedy those mistakes, Difference Generalized method of moments (GMM), pointed out by Arellano và Bover (1991), Blundell và Bond (1998), is introduced as the most suitable method to get unbiased, sustainable estimation results; unreliable test results as well. Contemporaneously, Arellano-Bond test on autocorrelation test at level 2 and Hansen test on exogenous instrumental variables will be used to test the suitability of estimated results via GMM. It was selected based on the balance data and estimated results by the difference GMM and system GMM methods for the five cases mentioned in the research results. This solution was applied by other researchers (Cavallo and Daude, 2008).

### 3.3. Research data

It is the fact that the limitation of time-series data in Vietnam makes trouble for research crowding out at the national level. Many violations mentioned above can result from lack of data and a lot of variables in the model. The information from time-series data which mainly collected since the 1990s can give about 25 observations while the standard minimum quantity in econometric requires 30 observations. This makes the residuals of models go abnormal distribution. It is the same meaning that time-series data is insufficient to conduct this study. At once, a big amount of variables in regression models with a little number of observations due to time-series data, if any, will lead to inefficient, unreliable estimation and test results. Hence, information from 63 provinces from 2006-2014 is used instead. These data are supplied by Vietnamese General Statistics Office (GSO), including private investment, budget spending, FDI, labour force, total export and import revenue, inflation rate, and growth economic of 63 local regions. The remaining variables such as foreign exchange rate, financial development as well as institutional quality are retrieved from World Development Indicators database, World Bank's Financial Structure database and Government Indicators database respectively.

## 4. Research results

### 4.1. Descriptive statistics

**Table 1.** Descriptive statistics.

Variable	Units	Source	Obs	Mean	Min	Max	Std. Dev.
PriC	% of GDP	GSO	567	22.81	1.00	71.41	9.35
PubC	% of GDP	GSO	567	34.80	2.61	150.11	25.46
DE	% of GDP	GSO	567	7.20	0.83	35.13	5.46

CE	% of GDP	GSO	567	27.61	1.35	137.53	21.68
Fdi	% of GDP	GSO	567	5.11	0.00	150.83	10.80
Lab	%	GSO	567	2.06	-16.12	17.80	3.01
EI	% of GDP	GSO	567	100.69	0.19	4234.26	326.01
Gdp <sub>g</sub>	%	GSO	567	9.42	-25.64	148.22	10.59
Inf	%	GSO	567	-0.12	-23.48	24.33	7.65
Exch	VND/USD	WB	567	18610.98	15994.25	21148.00	2141.39
FD		WB, author's calculation	567	19.59	1.69	1055.62	49.71
Ins	0-100	WB	567	35.04	33.24	36.57	1.05

Source: Author's calculation

In terms of private capital and budget expenditure over the period 2006-2014, the national average values were 22.81% and 34.8% GDP respectively (in which capital spending was 7.2% GDP, current one was 27.61% GDP). There was a coincident phenomenon when the maximum and minimum figure belongs to an area. For instance, the highest ratios to GDP belonged to Lai Chau province (71.41% for private investment in 2009, and 150.11% for government spending in 2012); whereas Ba Ria – Vung Tau province possessed the opposite values (about 1% for private investment in 2006, and 2.61% for government spending in 2011). The other average figures such as FDI, total exports and imports were 5.11%GDP and over 100%GDP. The similar number of labour force's growth and GDP growth made up 2.06%, 9.42%. Lastly, the average value of inflation ratio, official exchange rate; financial development index, and institutional quality index took account -0.12%; 18610.98; 19.59%, and 35.04 in sequence.

#### 4.2. Correlation matrix

Table 2. Pearson correlation coefficients.

	PriC	PubC	DE	CE	Fdi	Lab	EI	Gdp <sub>g</sub>	Inf	LogExc h	FD	Ins
PubC	0.2242*	1.000										
DE	0.1081*	0.7482*	1.000									
CE	0.2361*	0.9860*	0.6268*	1.000								
Fdi	-0.013	-	-0.069	-	1.000							
Lab	0.074	0.080	0.0960*	0.070	0.056	1.000						
EI	-	-	-	-	0.2188*	0.0828*	1.000					
Gdp <sub>g</sub>	-0.017	0.002	0.065	-0.014	0.1072*	0.062	0.036	1.000				
Inf	-0.017	-0.068	-0.015	-0.076	-0.056	-0.032	-0.028	0.079	1.000			
LogExc h	-0.008	0.077	-	0.1188*	0.0896*	-0.0882*	0.1030 *	-	-0.1789*	1.000		
FD	0.065	0.1279*	0.1566*	0.1107*	0.057	0.066	-0.021	-0.003	0.068	-0.0867*	1.000	
Ins	-0.018	0.052	-0.064	0.078	0.0949*	-0.047	0.074	-	-0.4383*	0.5541*	-	1.000

\* The significance levels at the 5%

Source: Author's calculation

In accordance with Pearson test result at the 5% significance level, all kinds of budget spending have the impact on private capital. There is a convincing evidence of this link is that correlation coefficient between current spending and private investment get maximum at 0.2361 whilst this value between development investment expenditure and private capital gives the minimum figure at 2.1081. In influence trend terms, all total and categories connecting budget consumption affect private capital positively. In other words, it is unaware of the existence of the crowding out effect between public and private spending in Vietnam in the 2006-2014 period. The remaining variables have the same

impact on private investment, but exchange rate. In fact, WB database (2017) showed that Vietnam had surplus exports in only 2012. The combination of frequent imports and uptrend exchange rate lead to disadvantages for business activities, decreasing capital of private sector.

Also at a significance level at 5%, test results prove that linkage of independent variables exists with very small correlation coefficients, except the case of current and development investment expenditure variable. Because its Pearson correlation coefficient is  $0.6828 < 0.8$ , it is confirmed that two above variables disconnect closely. Furthermore, variance-inflation factors (VIF) of all independent variables in model 2 are smaller than 2. In short, there does not exist the phenomenon of multi-collinearity between the independent variables in both two models.

### 4.3. Regression result

Regression process about crowding out of public spending on private capital is carried out in the following sequence which differences in some independent variables.

1- Regressing with dependent variable (private investment), independent variables regarding public spending (general government budget spending in model 1, development investment and current spending in model 2), and control variables (foreign investment, labour force, total export-import turnover);

2- Regressing with above variables and some independent variables added to reflect the impact of macroeconomic stability: economic growth, inflation, exchange rate as well. Besides, the interactive dummy variables between public expenditure and macroeconomic certainty variables are added to assess how macroeconomic factors affect crowding out;

3- Regressing with function which is similar to regression 1 and complement independent variables related to the impact of financial development, including financial development variable as well as the interactive dummy variable between government spending and financial development;

4- Regressing with both the same variables in regression 1 and independent variables illustrating the influence of institution's quality, that are institutional quality variable, the interactive dummy variable between government expenditure and institutional quality;

5- Regressing with all mentioned above variables simultaneously.

Results from regressions are shown in Table 3 and 4, in which Table 3 reports information about general state budget spending while Table 4 shows the results of the remaining fiscal variables.

**Table 3. Crowding out effect of total budget expenditure on private investment (one-step difference GMM)**

	<b>Regr.1</b>	<b>Regr.2</b>	<b>Regr.3</b>	<b>Regr.4</b>	<b>Regr.5</b>
PriC_1	0.694 [0.000]***	0.434 [0.000]***	0.690 [0.000]***	1.056 [0.001]***	0.538 [0.000]***
PubC	0.159 [0.002]***	1.784 [0.144]	0.157 [0.031]**	-1.618 [0.009]***	1.581 [0.209]
Fdi	0.000 [0.993]	-0.002 [0.970]	-0.001 [0.981]	-0.010 [0.857]	-0.012 [0.779]
Lab	0.133 [1.410]	0.106 [0.187]	0.130 [0.172]	0.131 [0.242]	0.100 [0.235]
EI	-0.002 [0.261]	-0.002 [0.251]	-0.002 [0.262]	-0.002 [0.414]	-0.001 [0.355]
Gdpg		-0.114 [0.000]***			-0.121 [0.000]***
Inf		0.041 [0.369]			-0.015 [0.784]
LogExch		-1.147 [0.811]			2.088 [0.687]
FD			0.000 [0.992]		-0.004 [0.910]
Ins				-1.206 [0.035]**	-1.106 [0.031]**



PubC*Gdpg		0.003			0.003	
		[0.000]***			[0.001]***	
PubC*Inf		-0.001			0.000	
		[0.189]			[0.982]	
PubC*LogExch		-0.169			-0.280	
		[0.173]			[0.034]**	
PubC*FD			0.000		0.000	
			[0.943]		[0.890]	
PubC*Ins				0.050	0.037	
				[0.005]***	[0.004]***	
Observations	441	441	441	441	441	441
Instruments	11	17	13	13		21
F test (p-value)	0.000	0.000	0.001	0.003	0.000	0.000
AR(1) test (p-value)	0.000	0.000	0.000	0.000	0.000	0.000
AR(2) test (p-value)	0.189	0.286	0.179	0.418		0.536
Sargan test (p-value)	0.012	0.147	0.011	0.070		0.112

\*\*\* The significance levels at the 1%.

\*\* The significance levels at the 5%.

\* The significance levels at the 10%.

Source: Author's calculation

In model 1, Wald results (F test) in all five cases show that the null hypotheses (beta coefficients of independent variables are equal to 0) are rejected at 1% significance level. This also means that regression model by one-step difference GMM has significance in explaining the affectation on dependent variable. Regarding the suitability of model, because Arellano-Bond test results for 2-level autocorrelation in all five circumstances have  $P_{value} > 10\%$ , there are insufficient conditions to reject the null hypotheses. Sargan tests of over-identified restrictions for situations 1, 3, and 4 own results with  $P_{value} < 10\%$ , so the null hypotheses can be rejected. Therefore, just case 2 and 5 are most appropriate to examine the crowding out effect of state budget expenditures on private investment in Vietnam.

Similar argument for model 2, only regression result in case 5 does not exist 2-level autocorrelation violation and identified restriction. Thus, it is used to test the impact of development investment and current expenditure as well as other elements on private investment in Vietnam.

**Table 4. Crowding out effect of capital and current expenditure on private investment (one-step difference GMM)**

	Regr.1	Regr.2	Regr.3	Regr.4	Regr.5
PriC_1	0.555 [0.000]***	0.385 [0.000]***	0.550 [0.000]***	1.010 [0.002]***	0.527 [0.000]***
DE	0.483 [0.000]***	-10.678 [0.184]	0.498 [0.002]***	8.200 [0.024]**	-12.734 [0.143]
CE	0.092 [0.078]*	4.924 [0.008]***	0.093 [0.187]	-3.205 [0.002]***	5.741 [0.004]***
Fdi	-0.001 [0.983]	0.003 [0.938]	-0.002 [0.965]	-0.005 [0.924]	-0.007 [0.856]
Lab	0.146 [0.096]*	0.102 [0.194]	0.142 [0.108]	0.109 [0.315]	0.079 [0.339]
EI	-0.002 [0.246]	-0.002 [0.247]	-0.002 [0.248]	-0.002 [0.350]	-0.002 [0.302]
Gdpg		-0.094 [0.003]***			-0.104 [0.002]***

Inf		0.009			-0.029
		[0.855]			[0.603]
LogExch		-0.415			1.806
		[0.932]			[0.732]
FD			0.007		0.000
			[0.870]		[0.998]
Ins				-0.625	-0.678
				[0.283]	[0.183]
DE*Gdpg		-0.005			-0.004
		[0.428]			[0.481]
DE*Inf		0.011			0.005
		[0.086]*			[0.467]
DE*LogExch		1.122			1.932
		[0.171]			[0.025]**
DE*FD			-0.001		0.000
			[0.875]		[0.955]
DE*Ins				-0.216	-0.166
				[0.035]**	[0.027]**
CE*Gdpg		0.004			0.003
		[0.002]***			[0.008]***
CE*Inf		-0.003			0.000
		[0.044]**			[0.819]
CE*LogExch		-0.491			-0.845
		[0.010]**			[0.000]***
CE*FD			0.000		0.000
			[0.972]		[0.971]
CE*Ins				0.311	0.076
				[0.014]**	[0.000]***
Observations	441	441	441	441	441
Instruments	12	21	15	15	27
F test (p-value)	0.000	0.000	0.000	0.001	0.000
AR(1) test (p-value)	0.000	0.000	0.000	0.000	0.000
AR(2) test (p-value)	0.303	0.395	0.291	0.545	0.951
Sargan test (p-value)	0.013	0.088	0.012	0.072	0.137

\*\*\* The significance levels at the 1%.  
 \*\* The significance levels at the 5%.  
 \* The significance levels at the 10%.

*Source: Author's calculation*

The information from two tables shows that several variables in models which have statistical significant produce diverse judgements. In terms of the most serious relationship in this study, both Vietnamese state budget expenditure and development investment expenditure do not influence private investment when testing at the 10% significance level. It is not difficult to meet that thing in realistic since the phrasal verbs “waste, loss, less effect” are quite popular when commenting on public investment. They mainly result from less economical feature, less control, overestimation in many items of development investment spending. Those are barriers to improvement in marginal productivity of capital, as noted in the literature review, leading to have not much subsidy for investment in private sector although expenditure on development investment is always given priority to rise. By contrast, this impact is positive for current spending at very small significance level at 1%. It can be explained that expenditure on education, health, etc., which belong to current consumption, have an effect on increasing quality of labour force, labour productivity, and business efficiency, making a great encouraging motivation to private investment. In short, there is disappearance of the

crowding out of public spending on private investment. Moreover, the existence of statistical significance of the interactive dummy variables between current spending and economic growth, exchange rate as well as institutional quality supports that macroeconomic conditions and institution affect the assistance of current consumption with private capital. In detail, exchange rate has negative impact and the remainders are the reverse.

Regarding other independent variables, at the 1% significance level, the one-lagged private investment and output growth in both models happen to private investment with opposite trend. The positive impact occurs to the one-lagged private investment, bringing the conclusion that the current investment of private sector is based on its previous one. It can be explained that the optimistic figure of investment in the past motivates the investors to continue investing with business targets of earning more and more revenues and profits. By contrast, the adverse influence of economic growth on private investment proves that regions having high growth rate have not much private capital. It can be explained that private investors in Vietnam tend to focus on low-growth localities in order to limit competitive pressures on other large companies. Furthermore, the reduction in institutional quality has detrimental affectation on private investment in model 1. Although Vietnamese institution clearly improves over time (from 34.57 in 2006 to 36.42 in 2014) but less than average value (this indicator ranks between 0 and 100), impacting upon business activities and investment environment, leading to limit the amount of private capital. An issue which should be pointed out is Voice and Accountability – an index of institutional quality. It just takes account 8.89, illustrating residents' low attendance to building institution in Vietnam.

## 5. Conclusion

The models are analysed by the one-step GMM with dynamic panel data from all 63 locals in Vietnam. Along the paper, general government spending is separated into development investment and current expenditure in order to have further examination about effect of each kind of public spending on private investment. As a consequence, our study produces several different conclusions.

At first, there is a supportive impact of current consumption on private capital from 2006 to 2014. This is also a proof for an argument of Ahmed and Miller (2000) when they found that expenses for transport and communication crowd in investment in developing countries. A note in this paper is that aggregate budget spending and development investment expenditure have no crowding out which was pointed out in Su Dinh Thanh (2011). The discouragement of government and capital spending from enhancing private capital is a result of the inefficiency in management and using budget. Therefore, it is extremely essential to have strict control on the process of investment using public expenditure, including planning, estimating, conducting as well. Also, the supportive relationship between current spending and private capital is affected by economic growth and institutional quality positively, and exchange rate negatively.

Beside motivation from government spending, capital in private sector has positive connection with itself in the previous year. This is the same suggestion with Cavallo and Daude (2011), Erden and Holcombe (2005). So, it is essential to open up the financial flow; facilitate investors who gave capital in the past as the previous capital is the real evidence and promotion, attracting the following.

Finally, the relationships between private investment sector and output growth as well as institutional quality are negative. The low quality of institution is the minus sign for business environment, declining demand and the amount of investment capital in private sector. Hence, the innovations from both the local authorities and the government are crucial, and the more significant thing is that they should aim to fully meet expectations and guarantee interests of investors.

## References

- [1] Adams, S. (2009). Foreign direct investment, domestic investment, and economic growth in Sub-Saharan Africa. *Journal of Policy Modeling*, 31(6), 939-949.
- [2] Afonso, A., St Aubyn, M. (2009). Macroeconomic rates of return of Public and Private investment: Crowding-in and Crowding-out effects. *The Manchester School*, 77(s1), 21-39.
- [3] Agosin, M. R., & Machado, R. (2005). Foreign investment in developing countries: does it crowd in domestic investment?. *Oxford Development Studies*, 33(2), 149-162.
- [4] Ahmed, H., Miller, S.M (2000). Crowding-out and crowding-in effects of the components of government expenditure. *Contemporary Economic Policy*, 18(1), 124-133.
- [5] Ameer, W., Xu, H., & Alotaish, M. S. M. (2017). Outward foreign direct investment and domestic investment: evidence from China. *Economic Research-Ekonomska Istraživanja*, 30(1), 777-788.
- [6] Anyanwu, J. C. (2012). Why does Foreign direct investment go where it goes?: New evidence from African countries. *Annals of economics and finance*, 13 (2), 425-462.
- [7] Arellano, M., Bond S. (1991). Some tests of specification for panel data: Monte Carlo evidence and an application to employment equations. *Review of Economic Studies*, 58, 277-297.
- [8] Argimon, I., Gonzalez-Paramo, J.M & Roldan, J.M (1997). Evidence of public spending crowding-out from a panel of OECD countries. *Applied Economics*, 29(8), 1001-1010.
- [9] Aschauer, D.A. (1989). Does public capital crowd out private capital?. *Journal of monetary economics*, 24(2),

- 171-188.
- [10] Bahal, G., Raissi, M. & Tulin, V. (2015). Crowding-Out or Crowding-In? Public and Private Investment in India. IMF Working Paper WP/15/26.
- [11] Belkhir, M., Maghyreh, A. & Awartani, B. (2016). Institutions and corporate capital structure in the MENA region. *Emerging Markets Review*, 26, 99–129.
- [12] Blejer, M.I, Khan, M.S (1984). Government policy and private investment in developing countries, *IMF Staff Papers*, 31(2), 379-403.
- [13] Blundell, R., Bond, S. (1998). Initial conditions and moment restrictions in dynamic panel data models. *Journal of Econometrics*, 87, 11–143.
- [14] Carrasco, M. (1998). Crowding Out and Government Spending. *University Avenue Undergraduate Journal of Economics*, 2(1), 4.
- [15] Cavallo, E., Daude C. (2011), Public investment in developing countries: A blessing or a curse?. *Journal of Comparative Economics*. 39(1), 65-81.
- [16] Demirguc-Kunt, A, Levine, R. (1999). Bank-based and market-based financial system: cross-country comparisons (Vol. 2143). World Bank publications.
- [17] Đào Thị Bích Thủy (2014). Tác động của chi tiêu cho tiêu dùng của chính phủ đến tăng trưởng kinh tế: Trường hợp ASEAN-5 thời kỳ 1990 – 2012. *Tạp chí Khoa học ĐH Quốc gia Hà Nội, Kinh tế và Kinh doanh*, Số 1(30), 46-52.
- [18] Easterly, W., Rebelo, S. (1993). Fiscal policy and economic growth. *Journal of monetary economics*, 32(3), 417-458.
- [19] Erden, L., Holcombe, R.G. (2005). The effects of public investment on private investment in developing economies. *Public Finance Review*, 33(5), 575-602.
- [20] Everhart, S. S., & Sumlinski, M. A. (2001). Trends in private investment in developing countries: statistics for 1970-2000 and the impact on private investment of corruption and the quality of public investment (Vol. 44). World Bank Publications.
- [21] Furceri, D., Sousa, R.M. (2011). The Impact of Government Spending on the Private Sector: Crowding-out versus Crowding-in Effects. *Kyklos*, 64(4), 516-533.
- [22] Ghura, D., Goodwin, B. (2000). Determinants of private investment: a crossregional empirical investigation. *Applied Economics*, 32, 1819-1829.
- [23] Givens, D. M. (2010), Four essays in the measurement of governance institutions. Doctor of Philosophy, University of Maryland.
- [24] Gjini, A., Kukeli, A. (2012). Crowding-out effect of public investment on private investment: An empirical investigation. *Journal of Business & Economics Research (Online)*, 10(5), 269.
- [25] Khan, M.S, Kumar, M.S (1997). Public and private investment and the growth process in developing countries. *Oxford bulletin of economics and statistics*, 59(1), 69-88.
- [26] Levine, R. (2002). Bank-based or Market-based Financial Systems: Which is better?. *Journal of Financial Intermediation*, 11(4), 398-428.
- [27] Sử Đình Thành (2011). Đầu tư công chèn lấn hay thúc đẩy đầu tư khu vực tư nhân ở Việt Nam?. *Tạp chí Phát triển kinh tế*, 251, 37-45.
- [28] Tô Trung Thành (2011). Đầu tư công "lấn át" đầu tư tư nhân? Góc nhìn từ mô hình thực nghiệm VECM. *Kỷ yếu hội thảo: Kinh tế Việt Nam: Những vấn đề đặt ra trong trung và dài hạn*, Cần Thơ, Việt Nam.
- [29] Government Indicators database. Retrieved from <http://data.worldbank.org/data-catalog/worldwide-governance-indicators>.
- [30] Financial Structure database. Retrieved from <http://www.worldbank.org/en/publication/gfdr/data/financial-structure-database>.
- [31] World Development Indicators database. Retrieved from <http://data.worldbank.org/data-catalog/world-development-indicators>.

# Industry 4.0 and Innovative Opportunities for Logistics Sector

Mai Tran Thi Phuong<sup>a\*</sup>, Ninh Vu Viet<sup>b</sup>

<sup>a</sup> Department of International finance, Academy of Finance

<sup>b</sup> Number 1, Le Van Hien street, Duc Thang precinct, Bac Tu Liem district, Hanoi, Vietnam

## ABSTRACT

Industry 4.0, referred to as the “Fourth Industrial Revolution”, also known as “smart manufacturing”, “industrial internet” or “integrated industry”, is currently a much-discussed topic that supposedly has the potential to affect entire industries by transforming the way goods are designed, manufactured, delivered and paid. This paper seeks to discuss the opportunities of logistics management in the context of Industry 4.0, since implications are expected in this field.

**Keywords:** Industry 4.0, Cyber-physical systems, Internet of services, the internet of things

## 1. Introduction

In recent years, complexity and requirements in the manufacturing industry have steadily increased. Factors such as growing international competition, increasing market volatility, demand for highly individualised products and shorted product life cycles present serious challenges to companies. It seems that existing “approaches” of value creation are not suited to handle the increasing requirements regarding cost efficiency, flexibility, adaptability, stability and sustainability anymore. On one hand, requirements in the manufacturing industry have increased. On the other hand, the rapid technological progress in the more recent past has opened up a range of new business potentials and opportunities. Trends and new catchwords such as digitalization, the internet of things (IoT), internet of services (IoS) and cyber-physical systems (CPS), are becoming more and more relevant. Against this backdrop, Germany, which is well known for its strong manufacturing sector, launched the so-called “Industrie 4.0” initiative in 2011 as part of its high-tech strategy, introducing the idea of a fully integrated industry. Since then, Industry 4.0 has gained attention importance – also beyond the German-speaking area – and has even been listed as a main topic on the 2016 World Economic Forum’s agenda. In concrete terms, Industry 4.0 means participating in the development, merchandising and operation of autonomous, knowledge and sensor-based, self-regulating production systems. The opportunities and benefits that are anticipated to come along with Industry 4.0 seem to be manifold, eg. Resulting in highly flexible mass production, real-time coordination and optimisation of value chain, reduction of complexity cost or the emergence of entirely new services and business models.

As far as the field of logistics is concerned, major implications are predicted, too. In fact, logistics represents an appropriate application area for Industry 4.0 [2]. The integration of CPS and IoT into logistics promises to enable a real-time tracking of material flow, improved transport handling as well as an accurate risk management, to mention but a few prospects. In fact, one could argue that Industry 4.0 in its pure vision can only become reality of logistics is capable of providing production systems with the needed input factors at the right time, in the right quality and in the right place. As promising as the idea of a self-propheying “Fourth Industrial Revolution” may sound at the first sight, it is essential to remark that there is a multitude of challenges, risks and barriers with regard to its implementation. Traditional industry boundaries will vanish due to reorganization of value creation processes and cause severe changes within and across organizations. Defining appropriate infrastructures and standards, ensuring data security and educating employees are among the issues that need to be addressed on the road to Industry 4.0. Unsurprisingly, a huge number of practitioner-oriented articles and papers address the opportunities of Industry 4.0 and seek to motivate (or even urge) companies to participate in the initiative. Although the term Industry 4.0 roots back to Germany’s high-tech strategy and thus has received a lot of attention recently, it still lacks a precise, generally accepted definition. This situation must be considered unsatisfying, especially from a scientific point of view. Against the backdrop, our ambitions are reflected by the following research question: “What are opportunities that Industry 4.0 will bring to

\* Corresponding author. Tel.: +84.979.683.599  
E-mail address: tranphuongmai88@gmail.com

logistics sector in the future?”

With regard to the structure of this paper, five main parts can be distinguished: The first section of the paper is devoted to introducing and emphasizing the topicality of Industry 4.0. Moreover, the aim, research question, structure and methodology are covered. Following that, a comprehensive literature review on the subject of Industry 4.0 conducted in the second part so as to lay a solid theoretical foundation for the subsequent research. In the third section, two well known logistics concepts are analysed with respect to potential Industry 4.0 consequences. The fourth part of the paper comprises current status of logistics sector in Vietnam and the last one is the conclusion.

## 2. Literature review

The industrial sector plays a crucial role in Europe, serving as a key driver of economic growth (e.g. job creation) and accounting for 75% of all exports and 80% of all innovations [5]. However, the European manufacturing landscape is twofold. While Eastern Europe and Germany show a constantly growing industrial sector, many Western European countries such as Great Britain or France have experienced shrinking market shares in the last two decades. While Europe has lost about 10% of its industrial share over the past 20 years, emerging countries managed to double their share, accounting for 40% of global manufacturing. A few years ago, Germany started thinking about initiatives in order to maintain and even foster its role as a “forerunner” in the industrial sector. Eventually, the term Industry 4.0 was publicly introduced at the Hanover Trade Fair in 2011, presented as part of Germany’s high- tech strategy so as to prepare and strengthen the industrial sector with regard to future production requirements [6]. While the IoT is assumed to take on a leading role in the Industry 4.0 era, Hermann et al [7] found that the IoS will find its way into factories, too. CPS, which are able to interact with their environment via sensors and actuators, constitute another element of Industry 4.0, since they are expected to enable factories to organise and control themselves autonomous in a decentralised fashion and in real time [3]. Due to their capabilities, these factories are often referred to as “smart factories”. Given all these concepts, the difficulty of finding a unique and concise definition for Industry 4.0 becomes apparent, and it is hardly surprising that opinions among researchers and practitioners diverge. Moreover, it is still uncertain how Industry 4.0 will manifest itself in practice and how much time that will take. With respect to a more precise understanding of the topic, we now try to clarify the core components of Industry 4.0.

Hermann et al [7] identified four Industry 4.0 key components based on a review of academic and business publications, using different publication databases so as to ensure objectivity. These key components are now briefly described.

**Cyber-physical systems (CPS):** Industry 4.0 is characterised by an unprecedented connection via the internet or other distributed ledgers and so-called CPS, which can be considered systems that bring the physical and the virtual world together. More precisely, “cyber-physical systems are integrations of computation with physical processes. Embedded computers and networks monitor and control the physical processes, usually with feedback loops where physical processes affect computations and vice versa”[8]. In the manufacturing context, this means that information related to the physical shop floor and the virtual computational space are highly synchronised [9]. This allows for a whole new degree of control, surveillance, transparency and efficiency in the production process. With regard to their structure, CPS have “two parallel networks to control, namely a physical network of interconnected components of the infrastructure and a cyber network comprised of intelligent controllers and the communication links among them” [10]. CPS realise the integration of these networks through the use of multiple sensors, actuators, control processing units and communication devices.

**Internet of things (IoT):** The term “internet of things” became popular in the first decade of the 21st century and can be considered an initiator of Industry 4.0 [11]. “Smart, connected products offer exponentially expanding opportunities for new functionality, far greater reliability, much higher product utilization, and capabilities that cut across and transcend traditional product boundaries”[12] (Porter and Heppelmann, 2014; p. 4). Also Nolin and Olson [13] note that the IoT “seems to envisage a society where all members have access to a full-fledged Internet environment populated by self-configuring, self-managing, smart technology anytime and anywhere” (p. 361). The IoT is expected to open up numerous economic opportunities and can be considered one of the most promising technologies with a huge disruptive potential. For the purpose of clarification, Fleisch [14] stresses the need to distinguish the IoT concept from the “ordinary” internet, arguing that “the nerve ends in the IoT are very small, in many cases even invisible, low-end and low energy consumption computers, whereas the nerve ends of the Internet are full-blown computers” (p. 3). Moreover, the number of network nodes in the IoT is significantly higher than in the conventional internet (“trillions versus billions”). Eventually, literature provides a wide range of definitions for the IoT. Some of them are very specific, other ones feature a more general character. For pragmatic reasons, this paper sticks to a rather comprehensive definition by referring to the IoT as a world where basically all (physical) things can turn into so-called “smart things” by featuring small computers that are connected to the internet [14].

**Internet of services (IoS):** It is often said that we are living in a so-called “service society” these days [15]. With respect to that, there are strong indications that, similar to the IoT, an internet of services (IoS) is emerging, based on the idea that services are made easily available through web technologies, allowing companies and private users to

combine, create and offer new kind of value- added services [16]. It can be assumed that internet-based market places of services will play a key role in future industries. Whereas from a pure technological perspective, concepts such as service- oriented architecture (SOA), software as a service (SaaS) or business process outsourcing (BPO) are closely related to the IoS, Barros and Oberle [17], propose a broader definition of the term service, namely “a commercial transaction where one party grants temporary access to the resources of another party in order to perform a prescribed function and a related benefit. Resources may be human workforce and skills, technical systems, information, consumables, land and others” (p. 6). For the purpose of this paper, we will follow the latter definition.

**Smart factory:** Up to now, CPS, the IoT and IoS were introduced as core components of Industry 4.0. It must be noted that these “concepts” are closely linked to each other, since CPS communicate over the IoT and IoS, therefore enabling the so-called “smart factory”, which is built on the idea of a decentralised production system, in which “human beings, machines and resources communicate with each other as naturally as in a social network” [11, p.9]. The close linkage and communication between products, machinery, transport systems and humans is expected to change the existing production logic. Therefore, smart factories can be considered another key feature of Industry 4.0. In the smart factory, products find their way independently through production processes and are easily identifiable and locatable at any time, pursuing the idea of a cost efficient, yet highly flexible and individualised mass production. [11] note that smart factories “will make the increasing complexity of manufacturing processes manageable for the people who work there and will ensure that production can be simultaneously attractive, sustainable in an urban environment and profitable” (p. 21). Hence, the potentials that might come along with smart factories are expected to be huge. It is important to understand that not only production processes but also the roles of employees are expected to change dramatically. Spath et al. [9] expect employees to enjoy greater responsibility, to act as decision makers and to take on supervising tasks instead of driving forklifts, for instance. In the same context, some critics have recently pointed out that the automated and self- regulating nature of the smart factory might cause severe job destruction. However, hardly any reliable study supports that fear. Beyond these key components, there is an increasing set of further Industry 4.0 technologies in a broader sense, such as wearables (e.g. smart watches, glasses or gloves), augmented reality applications, autonomous vehicles (incl. drones), distributed ledger systems (e.g. the blockchain) or even big data analytics.

As a first preliminary summary, we define Industry 4.0 as follows:

- Products and services are flexibly connected via the internet or other network applications like the blockchain (The blockchain is a distributed, public ledger which is collectively kept up to date according to strict rules and general agreement. The blockchain enables to reach a consensus in a system with potentially malicious actors and without a central authority).
- The digital connectivity enables an automated and self- optimised production of goods and services including the delivering without human interventions (self-adapting production systems based on transparency and predictive power).
- The value networks are controlled decentralised while system elements (like manufacturing facilities or transport vehicles) are making autonomous decisions (autonomous and decentralised decision making).

With respect to logistics management, Industry 4.0 is expected to achieve opportunities in terms of decentralisation, self- regulation and efficiency.

### 3. Industry 4.0: implications for logistics management

#### Approach

We now aim to answer the question whether logistics management might be affected by Industry 4.0. Thereby, we follow the conceptual research approach suggested by Meredith [4]. Our argumentation is based on a simple logistics-oriented Industry 4.0 application model as described in Figure 1

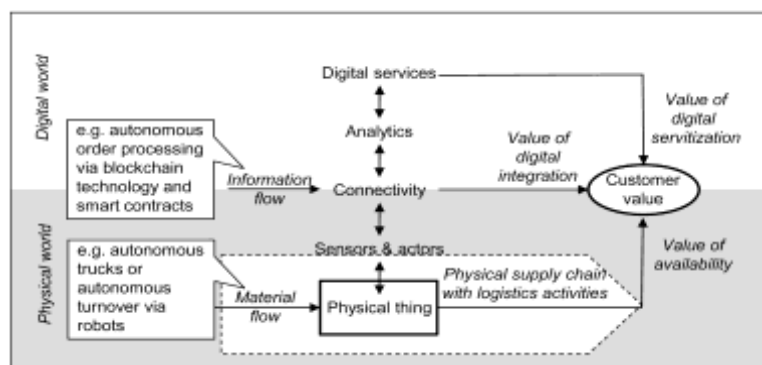

**Fig. 1. A logistics-oriented Industry 4.0 application model.**

(Source: According to 18, p.7)

The model encompasses two dimensions:

Physical supply chain dimension: Autonomous and self-controlled logistics sub systems like transport (e.g. via autonomous trucks), turnover handlings (e.g. via trailer unloading or piece picking robots) or order processing (e.g. via smart contracts on the blockchain technology) are interacting among each other.

Digital data value chain dimension: Machine and sensor data are collected at level of the “physical thing” along the entire physical end-to-end supply chain. Via a connectivity layer the gathered data is provided for any kind of analytics (e.g. in the cloud), possibly resulting in potential value-added business services.

Out of this two-dimensioned application model, three customer value components are expected. First, the “value of availability”, means making products and services available to the customer via autonomous delivering. Value creation through availability of goods or services is the main added value of logistics activities and services. Second, “value of digital integration” arises through a permeable transparency and traceability along the supply chain. Furthermore, order processing systems are interconnected, facilitating seamless business executions (e.g. object self-service, remote usages or condition monitoring). Third, consumption normally exceeds the classical point-of-sale (POS), but this does not mean that the supply chain ends at this point. There exist several IT-based service options going beyond the simple distribution of products or physical services (=“value of digital servitization”). Aside digitally charged things where physical products are “charged” with additional digital services, the data itself creates value outside the original use case (“sensor as a service”)

In such a case the machines will directly communicate and transfer materials with each other without involving any visible intervention or human work. The concepts cross-company-oriented Kanban and JIT/JIS are two important operational level techniques which may be affected by new technologies, such as IoT or autonomous transport. They seem to be more appropriate to be discussed in the context of Industry 4.0 as compared to those tactical-level approaches such as VMI and Cross-docking.

Just-in-Time (JIT) is a prominent and widely accepted concept in production and logistics, especially in the automotive industry. JIT primarily focuses on the supplier-buyer relationship and can therefore be considered a cross-company approach. Its main objective is to realize a zero- or low-stock supply system. Moreover, JIT seeks for a demand-tailored realization of goods exchange processes within and across companies as well as short delivery cycle time and increases overall supply chain flexibility and agility. Whereas in short JIT calls for the right material to be supplied at the right time and in the right place, the so-called Just-in-Sequence (JIS) concept goes one step further by ensuring that the material also arrives in the right sequence with respect to its further processing. Hence, incoming material does not have to be sorted by the buyer anymore. JIS can therefore be considered an enhancement of JIT, which means that, apart from additional benefits (no sorting etc.), requirements are even higher, especially with regard to transport planning. JIT/JIS systems generally pass the following process steps and activities: (i) production planning, (ii) production order, (iii) disposition and production, as well as (iv) delivery

The Kanban concept originated in Japan and, generally speaking, can be considered a scheduling system in manufacturing. Its core characteristic is a rigid pull-orientation of the production processes, which is why terms such as pull concept or pull system are often used synonymously. Kanban, which is based on the idea of self-regulating loop systems, allows for a systematic reduction of inventory level and costs. In addition, a strictly demand-oriented production of rather small lot sizes alleviates so-called bullwhip effects, one of the major challenges in supply chain and logistics management. Yet, Kanban systems are suitable only if fluctuations in demand are rather small, both within the actual production system and with regard to the (end) customer. Therefore, flexible working time models might be required. Finally, especially cross-company Kanban systems only run successfully if high standards with regard to information flows and product quality can be ensured. Inaccuracies and mistakes pose a high risk and should therefore be avoided or at least be reduced to a minimum (“zero-defect policy”), since there is no or only little inventory kept in Kanban systems. Kanban systems across company borders include the following process steps and activities: (i) demand assessment, (ii) Kanban signal, (iii) disposition and production, (iv) collection and delivery, as well as (v) goods receipt.

The investigations in the main part revealed different Industry 4.0 opportunities in terms of decentralisation, self-regulation and efficiency. With respect to Kanban, an improved demand assessment, dynamic and more efficient milkruns as well as shortened cycle times can be expected. As far as JIT/JIS systems are concerned, reduced bullwhip effects, highly transparent and integrated supply chains as well as improvements in production planning are among the potential benefits. Industry 4.0 potentials should be evaluated situationally due to the complex nature of logistics management

#### **The linking of data and transport logistics**

As Industry 4.0 takes shape, transport logistics will also play an even more important role alongside data logistics. This especially entails the complete linking-up of all elements involved in the transport chain. In larger areas this is already a reality and in daily use in a number of applications: flexible route planning based on forecasts of the traffic situation or weather and software-assisted management of traffic flows are but two examples. But the technical development doesn't stop there. The introduction of intelligent, self-driving vehicles in a traffic infrastructure based on the Internet of Things will open the door to completely new dimensions and bring about more automated and flexible logistics solutions.

In this area data and transport logistics go hand in hand. The former provides the information which is then used



to optimize the transport logistics. The more extensively information on capacity, weather, traffic, and vehicles is shared, the more efficiently the growing logistics flows can be managed. In an age where production is growing and ever smaller batches are transported (keyword: e-commerce), the production and distribution sides are virtually dependent on the efficiency and flexibility of the transport logistics. The vision of a fourth industrial revolution in general and the concept of the Smart Factory in particular can only become reality in the first place if the logistics can guarantee that raw materials, primary products, and articles ready for shipping are in the right place at the right time.

#### 4. Current status of logistics sector in Vietnam

The World Bank in late 2015 forecast economic growth of 12 percent by 2020 with export and import turnover standing at \$623 billion, bolstering Vietnam's already solid reputation as an investment destination of choice. Its logistics sector, as demand increases, is in need of better quality services to seize the potential on offer. Yet Vietnam's logistics providers have still to find common ground with exporters. Most are small and medium size and short on capital and infrastructure such as warehousing, IT, and even vehicles. According to the Vietnam Logistics Business Association, logistics costs in Vietnam represent 25 percent of annual GDP, significantly higher than in countries such as the US, China and Thailand. When the TPP officially comes into being, tariffs on tens of thousands of goods will gradually come down to 0 percent, boosting Vietnam's imports and exports and requiring a logistics sector that can cope.

According to a report by HKTDC Research, Vietnam, situated to the southeast of the Indochinese peninsula and with a 3,200km coastline, depends heavily on sea freight transportation for its external trade. Since 2007, Vietnam's container port throughput has been expanding at a compound annual growth rate of 12.5%, reaching 8.1 million TEUs in 2013 (double the volume seen in 2007). Driven by exports from foreign-invested manufacturers and by the import of intermediate and capital goods, Vietnam's external trade again flourished in 2014, with exports and imports growing by 14% and 12%, respectively. A recent report from the Vietnam Logistics Business Association said that the sector recorded average growth of 20 to 24 percent each year despite the outsourcing logistics market only accounting for 3 to 4 percent of total GDP. In 2014 and 2015, 80 percent of enterprises in the sector reached or exceeded their annual plans. Seventy percent of logistics enterprises recorded profits while only 1 percent went bankrupt; much less than in other industries. A number of large firms, such as SNP, Gemadept, Vinafco, Transimex Saigon, Vinafreight, Viconship, Vietfracht, and Sotrans were viewed as operating in a very professional manner.

Figures from the Vietnam Logistics Business Association also show that the average charter capital of logistics companies is about VND4-6 billion (\$180,000- \$270,000); three or four times higher than in 2007. The number of small and medium-sized enterprises account for 72 percent, while the remainder are large enterprises with charter capital of more than VND 20 billion (\$890,000). The number of enterprises using integrated logistics services providers or a third-party logistics provider (3PL) has grown over recent years and now account for 15 to 20 percent. The sector has continued to embrace information technology, with 10 percent of enterprises being equipped with Enterprise Resource Planning systems, 17 percent using Electronic Data Interchange, and most using customs and accounting software. In transport, 19 percent of enterprises use transportation management systems and 29 percent use GPS. Meanwhile, in warehousing, nearly 17 percent use bar code systems and warehouse management software.

Vietnam's logistics industry has built trust with not only domestic but also international customers, leveraging local advantages and cooperating with foreign firms to integrate logistics activities. Following Vietnam's 2007 World Trade Organization (WTO) accession, foreign investors were allowed to set up joint-venture logistics companies. Since 2012, it has been permissible for wholly foreign-owned enterprises (WFOEs) to provide international maritime transport and courier services. In line with its WTO commitment schedule, Vietnam's logistics sector further opened up from January 2014. As of that date, WFOEs have been allowed to provide container station and depot services, storage and warehouse services, as well as freight transport agency services. Notably, there is a rising trend for both local and multinational enterprises to outsource logistics functions to third-party logistics services providers (3PLs). In addition, Vietnamese logistics companies are keen to collaborate with their foreign counterparts, particularly those that have a large customer base and a reputation for delivering high standards of services.

Thanks to its underdeveloped transport infrastructure and inadequate logistics facilities, logistics costs in Vietnam are estimated to run at about 25% of GDP, far higher than the 18% in China and the 13% in Malaysia. This presages a huge scope for efficiency gains in the longer run, in particular through the establishment of Vietnamese-foreign collaborations. In a 2014 report, the World Bank noted that a more competitive transport and trade logistics system in Vietnam could be a new driver of sustained economic growth in the country, enhancing productivity as well as boosting business competitiveness. Currently, foreign companies dominate Vietnam's logistics market, particularly in the international transportation segment. There are about 40 foreign shipping firms in Vietnam, handling more than 80% of the country's imports and exports, primarily with regard to trade with the European and American markets.

According to the Vietnam Logistics Business Association, there are about 1,300 logistics companies in the country. Although domestic companies represent 80% of the total number of logistics firms, they only account for about 25% of total market share. Most of these home-grown businesses are small-scale companies with limited financial and human resources. With an eye on the growing and increasingly liberal logistics market, many global shipping

companies - including Maersk, NYK Line and APL - have strengthened their presence in Vietnam, offering a variety of value-added services, such as pre shipment inspection, labelling, and pick-and-pack. In addition, a number of Hong Kong logistics companies are now operating in Vietnam. Kerry Logistics, for example, has established logistics centers in Hanoi, Da Nang and Ho Chi Minh City. The expansion of the multinationals in Vietnam is creating a growing demand for supply-chain management facilities, particularly with regard to handling complex sourcing issues, production requirements and servicing sales networks. This growth, however, has spurred concerns among a number of the foreign logistics companies over lack of experienced and professional human resources in the Vietnamese logistics sector.

The “Fourth Industry Revolution” will use digital product models, which will be formed to a large degree in compliance with the requirements of customers, and will be produced in Smart factories. It is assumed that intelligent factories will largely have the ability to self-plan and self-adapt. The existence of a complete digital product model, together with the methods of its manufacture, model, intelligent factory with its real representation in networked Cyber Physical Systems are key conditions for the success of the “Fourth Industry Revolution”

## 5. Conclusions

Nowadays, the vast majority of businesses, including logistics companies, are determined to implement product, technical, technological and organizational innovation. Enterprises are focused on creating value for the customer, who is becoming more aware and demanding in terms of increased customer requirements relating to lead time delivery services, product availability and reliability. The newest solutions such as Internet of Things, Big Data and Industry 4.0 create opportunities to meet the needs of customers and also contribute to the development of logistics and supply chains management.

## References

- [1] D. Spath (Ed.), O. Ganschar, S. Gerlach, M. Hämmerle, T. Krause, S. Schlund, Studie: Produktionsarbeit Der Zukunft – Industrie 4.0 (2013). Retrieved June 8, 2015, from <http://www.iao.fraunhofer.de/images/iao-news/produktionsarbeit-der-zukunft.pdf>.
- [2] T. Bauernhansl, M. ten Hompel, B. Vogel-Heuser (Eds.), *Industrie 4.0 in Produktion, Automatisierung Und Logistik*, Springer, Wiesbaden, 2014.
- [3] M. Brettel, N. Friederichsen, M. Keller, M. Rosenberg, How virtualization, decentralization and network building change the manufacturing landscape: an industry 4.0 perspective, *Int. J. Mech. Ind. Sci. Eng.* 8 (1) (2014) 37–44
- [4] J. Meredith, Theory building through conceptual methods, *Int. J. Oper. Prod. Manage.* 13 (5) (1993) 3–11.
- [5] A. Dujin, A. Geissler, D. Horstkötter, Think Act. *Industry 4.0 – The New Industrial Revolution: How Europe Will Succeed*, (2014) Retrieved July 13, 2015, from [https://www.rolandberger.com/en/Publications/pub\\_industry\\_4\\_0\\_the\\_new\\_industrial\\_revolution.html](https://www.rolandberger.com/en/Publications/pub_industry_4_0_the_new_industrial_revolution.html).
- [6] M. Mittermair, *Industry 4.0 initiatives*, *SMT: Surf. mt. Technol.* 30 (3) (2015) p. 58–63.
- [7] M. Hermann, T. Pentek, B. Otto, *Design Principles for Industrie 4.0 Scenarios: A Literature Review*. Working Paper, Technical University of Dortmund, 2015
- [8] E.A. Lee, *Cyber Physical Systems: Design Challenges*, University of California at Berkeley: Electrical Engineering and Computer Sciences., 2008.
- [9] J. Lee, B. Bagheri, H.A. Kao, *A Cyber-Physical Systems Architecture for Industry 4.0-based Manufacturing Systems* University of Cincinnati, University Cooperative Research Center on Intelligent Maintenance Systems, 2014.
- [10] S. Parvin, F. Hussain, O. Hussain, T. Thein, J. Park, Multicyber framework for availability enhancement of cyber physical systems, *Computing* 95 (10-11) (2013) 927–948.
- [11] H. Kagermann, W. Wahlster, J. Helbig, *Recommendations for Implementing the Strategic Initiative INDUSTRIE 4.0*. Final Report of the Industrie 4.0 Working Group, (2013). Retrieved July 10, 2015, from [http://www.acatech.de/fileadmin/user\\_upload/Baumstruktur\\_nach\\_Website/Acatech/root/de/Material\\_fuer\\_Sonderseiten/Industrie\\_4.0/](http://www.acatech.de/fileadmin/user_upload/Baumstruktur_nach_Website/Acatech/root/de/Material_fuer_Sonderseiten/Industrie_4.0/)
- [12] M.E. Porter, J.E. Heppelmann, How smart connected products are transforming competition, *Harv. Bus. Rev.* 11 (2014) 1–23.
- [13] J. Nolin, N. Olson, The internet of things and convenience, *Internet Res.* 26 (2) (2016) 360–376.
- [14] E. Fleisch, *What Is the Internet of Things? An Economic Perspective*. (White Paper), Swiss Federal Institute of Technology in Zurich/University of St. Gallen, 2010.
- [15] P. Andersson, L.-G. Mattsson, Service innovations enabled by the internet of things, *IMP J.* 9 (1) (2015) 85–106.
- [16] W. Wahlster, H.J. Grallert, S. Wess, H. Friedrich, T. Widenka (Eds.), *Towards the Internet of Services: The THESEUS Research Program*, Springer, Switzerland, 2014.
- [17] A. Barros, D. Oberle (Eds.), *Handbook of Service Description*, Springer, New York, 2012
- [18] E. Fleisch, M. Weinberger, F. Wortmann, *Business Models and the Internet of Things*. Bosch IoT Lab White Paper, University of St.Gallen, 2014

International Conference For Young Researchers In Economics And Business, ICYREB 2017, October 30<sup>th</sup> 2017  
Da Nang, Vietnam

# Financial Enterprise Risks and Firm Performance: Case Study in Construction Sector in Vietnam

Luu Huu Duc, Diem T.T Hai\*

Department of Corporate finance, Academy of Finance, Hanoi, Vietnam  
Nong Lam, Duc Thang, Bac Tu Liem, Ha Noi, Vietnam

---

## ABSTRACT

“A firm’s ability to weather storms depends on how seriously executives take risk management when the sun is shining and no clouds are on the horizon.” Kaplan and Mikes confirmed in their article published in the Harvard Business Review, 2012. To manage the financial firm risk, we study controllable firm financial risks: liquidity risk and credit default risk in a relationship with firm financial performance. In particular, we focus on the impact of liquidity ratios and Z-score on the firm financial performance. On one hand, we find that liquidity ratios are negatively associated with both measures of firm performance in the construction sector in Vietnam. On the other hand, credit default risk measure registered a positive impact on the financial firm results. Our findings are consistent with the theory predicting the principles of risk management for the firm and particularly to the firms in constructions sector in an emerging country such as Vietnam.

**Keywords:** Financial risks; Firm financial performance; Construction sector

---

## 1. Introduction

In recent years, the issue of enterprise risk management has been gaining growing interest and support among both academicians and corporate managers around the world. Each business organization decision involves some kinds of risks. Most enterprise financial risks are not easily recognized and treated as firm managers expected. Consequently, the number of researches and different models to this issue has been ever larger. However, one of the fundamental questions regarding to risk management which remains unanswered is how the enterprise financial risks affect the firm performance exactly in some specific sectors of an economy such as construction. Thus, we examine the interaction between the firm financial risks and economic – financial results in construction firms in Vietnam, an emerging market which is registered as one of the rapidest growth markets in the world and construction sector has contributed a significant value to Vietnam’s actual dimension.

This research is conducted to achieve two objectives. First, we empirically examine how enterprise liquidity risk and financial performance interacts in the construction sector in Vietnam, and second, we investigate how financial risks affect firm financial performance to the existing investment opportunity or not. Examining such interdependence is also interesting from a modelling perspective as it would indicate whether we need hedge financial risks in presence of investment opportunity.

The paper is organized as follows. Apart from introduction in section 1, business risks (liquidity risk and credit default risk) and firm financial performance are discussed on the basis of the theory of corporate finance in section 2. Section 3 presents methodology in the research. In the next section, we show results of a study carried out on the basis of financial performance of Vietnamese construction listed companies. We then discuss the implications of the findings and conclude the research.

## 2. Enterprise risks and firm financial performance

This section discusses how enterprise risk can affect the firm financial performance. Risk is the possible variation

---

\* Corresponding author; Tel.: +84 966141469  
Email: t.diem@unimc.it

in an outcome from what is expected to happen. Business risk may arise from the business's nature, industry and environment. Business risks can be classified into four types: strategy risk, operational risk, product risk and financial risk. The first category of business risk refers to risks associated with the corporate, business or functional strategy. The second type of risk deals with the operational procedures; meanwhile, the next one connects with products/services expectation sales. The last category of risks arises from financial activities of the firm.

Specifically, we mention merely the controllable financial risks which are liquidity risk, credit default risk and financial leverage risk (Hayette 2003). In this paper, we only focus on the first two kinds of controllable financial risk because the nature of financial leverage risk is associated to a stand-alone side: financing activities.

Let us try with the first term referring to the liquidity risk – the risk that a given security or asset cannot be traded quickly enough in the market to prevent a loss – which is not a new phenomenon in financial markets. A firm has high level of liquidity risk means it owns a significant level of assets which finds difficulty to convert into cash without losing a considerable assets value. There are several theories which have been developed to study the effect of liquidity on financial performance. In the corporate finance management, it is said that a high liquidity level is considered to be a sign of financial strength; however, a high liquidity level can be as undesirable as a low possible profitability (Smith, 1980; Shin and Soenen, 1988; Deloof, 2003; Abuzar M.A. Eljelly, (2004); Lazaridis and Tryfonidis, 2006; Padachi, 2006; Gill, Biger and Mathur, 2010). This would be a consequence of the fact that current assets are usually less profitable than the fixed assets. It means that the money invested in current assets generates less returns than fixed assets, thus representing an opportunity cost. Besides, the amounts employed in current assets generate additional costs for management, which reduces the firm performance. However, Arnold (2008) points that holding cash also provides some advantages, such as providing the payment for daily bills or due to the fact that future cash flows are uncertain, holding cash may give a safety margin for eventual downturns and finally the ownership of cash guarantees the undertaken of highly profitable investments that demands immediate payment. The significance of liquidity to company performance might lead to the conclusion that liquidity risk has an impact on the firm performance.

Credit default risk refers to the risk that a borrower will default on any type of debt by failing to make required payments. The risk is primarily that of the lender and includes lost principal and interest, disruption to cash flows, and increased collection costs. Credit default risk contributes to the firm performance in terms of negative impact (Freeman, MC, Cox, PR & Wright, B 2006).

### 3. Methodology

Vietnam construction industry is one of the key economic sectors attracting investment. The share of construction sector in GDP of Vietnam is approximated from 5 percent to over 6 percent of GDP. Construction sector contributed a large value for the economic development in Viet Nam. The investment's value almost increased every year from 2009 to 2013 (at constant 2010 prices) even though total investment in 2011 decreased 2.3 percent. In 2015, the construction sector grew by 10.82% compared to previous year. This is the highest rate registered since 2010, while the average growth of GDP is 6.68%.

In the period 2011-2015, the private enterprise groups has always accounted for over 80% of the production structure of the construction industry, contributing an important role to promote the growth of the industry. Private sources not only contribute to the growth of the civil construction sector but also engaged in infrastructure development through contract BT, BOT, BOO and PPP. However, the legal framework for public-private partnerships (PPP) is limited; we cannot promote capital investment in the infrastructure sector.

Based on this background of construction sector with a number of factors of business risks, Vietnamese construction firms have not had a risk management process yet and helped managers understand the role of financial risks management. Hence, we aim to clarify the relationship between the controllable financial risks and firm performance in this research paper.

#### Sample

The primary source of our firm-level data is from the websites of the 47 firms listed in construction sector in Vietnam from 2009 to 2015. We also collect the price of company's stocks at the end of each year during the described period. In our analysis, we have a panel of 329 observations to study the two dimensions: firm financial risks and firm financial performance.

#### Empirical design

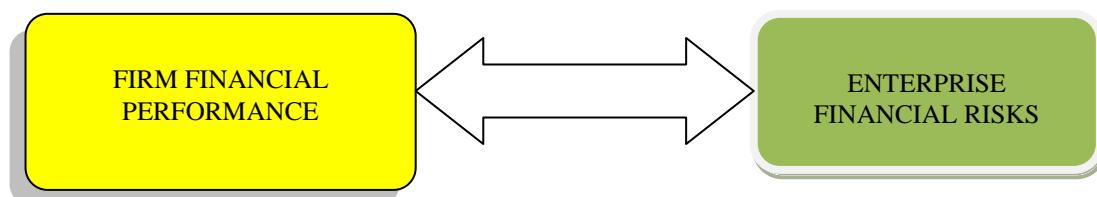

Variables measuring the firm financial performance

Performance<sub>i,t</sub> refers to our firm financial performance measures (TobinQ, Basic Economic Power (BEP)) of firm

i in year t. We consider the first measure of firm financial performance is TobinQ (Market value of total assets/Book value of total assets). The next measure of firm financial performance is Basic economic Power (BEP).

Variables measuring the firm financial risks

Firm\_risk<sub>i,t</sub> represents our firm financial risk measures. As explained above, khttn<sub>i,t-1</sub> (Current assets-Inventory)/Current Liabilities) is the main explanatory variable of interest, quick ratio. In the robustness, we use an alternative measure of liquidity ratio such as khttht<sub>i,t</sub> (Current assets on the current liabilities). Furthermore, we also use Z-score as a measure of enterprise credit default risk which is measured by a statistical-based method (Eidlema, (1995); Fatemi (2006)). On one hand, agreed with common understanding about credit risk, we believe that higher level of credit default risk, the lower results a firm can perform. On the other hand, agreed with the negative relationship between liquidity and performance, we suppose that in the construction sector, a higher level of liquid assets a firm owns a lower result it can perform due to the poor profitable ability of liquid assets.

The most well-known credit scoring is the Altman Z-Score (Altman, 1968, 2000) which is presented by the formula:

$$Z\text{-Score} = 1.2 X1 + 1.4 X2 + 3.3 X3 + 0.6 X4 + 0.999 X5$$

Where:

X1= Working capital/Total assets

X2= Retained earnings/Total assets

X3= Earnings before interest and taxes/Total assets

X4= Market value of equity/book value of debt

X5= Sales/Total assets

This credit scoring is considered as a signal of high probability of the company encountering financial distress when it is below 1.80 and in the other side, a company is considered to have a good position of credit risk if Z-Score is above 2.99. Even though, this scoring system presents a number of limitations such as formulated based on the US financial data at the firm level, however, it is still a good method to address the enterprise credit default risk.

Other variables

Controls<sub>i,t</sub> is the set of control variables. Specifically, we control for risk of financial leverage: DE<sub>i,t-1</sub> is the total book value of debt divided by the total book value of equity and firm size (Log of total assets), firm age (the number of years in which the firm has been founded);

Baseline model

We examine the effect of enterprise financial risks on a firm performance using the baseline model as follows:

$$\text{Performance}_{i,t} = \alpha_0 + \alpha_1 \text{Enterprise\_risk}_{i,t} + \alpha_2 \text{Controls}_{i,t} + \varepsilon_{i,t} \quad (1)$$

$$\text{Enterprise\_risk}_{i,t} = \alpha_0 + \alpha_1 \text{Performance}_{i,t} + \alpha_2 \text{Controls}_{i,t} + \varepsilon_{i,t} \quad (2)$$

Where:

Performance<sub>i,t</sub> refers to our firm financial performance measures (TobinQ, Basic Economic Power (BEP)) of firm i in year t. We consider the first measure of firm financial performance is TobinQ (Market value of total assets/Book value of total assets)<sup>†</sup>. The next measure of firm financial performance is Basic economic Power (BEP).

Enterprise\_risk<sub>i,t</sub> represents our enterprise financial risk measures. As explained above, khttn<sub>i,t-1</sub> (Current assets-Inventory)/Current Liabilities) is the main explanatory variable of interest, quick ratio. In the robustness, we use an alternative measure of liquidity ratio such as khttht<sub>i,t</sub> (Current assets on the current liabilities). Furthermore, we also use Z-score as a measure of enterprise credit default risk which calculated by using statistical-based and fundamentals of firm.

Controls<sub>i,t</sub> is the set of control variables. Specifically, we control for leverage: DE<sub>i,t-1</sub> is the total book value of debt divided by the total book value of equity, firm size (Log of total assets), firm age (the number of years since the firm has been founded);

### Summary statistics

Table 1 summarizes all variables used in the empirical analysis.

**Table 1. Summary statistics**

The sample includes of firms covered by 47 listed companies in Construction sector in Vietnam between 2009 and 2015.

stats	age	zz	wdf1	de	khttn	knttht	roe	bep	Size	tobinq
Mean (1)	27.19757	1.239645	2.243428	3.904869	.993664	1.421817	.1101349	.0529526	27.29092	1.034453
Sd (2)	14.06606	.9559708	2.116011	6.743529	1.322217	1.322648	.5795981	.0581289	1.184824	.4862822
Var (3)	197.8541	.9138802	4.477504	45.47518	1.748258	1.749397	.335934	.003379	1.403807	.2364704
Min (4)	4	-1.592871	.4941096	-29.84808	.2280447	.3346383	-2.364687	-.3622388	23.46968	.52609

Max (5)	59	11.81584	9.490603	67.28425	20.18772	20.46719	7.791023	.2647411	30.49927	5.590447
P5 (6)	8	.0615272	.4941096	.5589345	.3757724	.8250237	-.2419909	-.016041	25.6354	.7203481
P50 (7)	26	1.225689	1.516615	2.539639	.7918099	1.195952	.1014904	.0570133	27.20682	.9410083
P95 (8)	52	2.334273	9.490603	9.633103	1.66224	2.386506	.2973324	.1292681	29.41865	1.514623

Rows (1), (2), (3) of Table 1 respectively report means, standard deviations, Variances of the variables used for the whole sample. Similarly, rows (4), (5) report the min and max values, meanwhile rows (6), (7), (8) show their 5th, 50th and 95th percentile.

Mean (median) value of leverage is (D/E) is 3.9 means firms in construction sector in Vietnam use a high level of liabilities, however, not all their liabilities has to pay interest. Meanwhile, mean values of firm risk proxies are relatively high (1.239 for mean value of Zscore, 1.42 for current ratio and 0.99 for quick ratio) suggesting a low level of bearing financial corporate unsystematic risks. However, the range of variation for both credit default risk and liquidity risk is slightly high (from -1.59 until 11.8 for Z-score and from 0.2 to more than 20 for liquidity risks measures). This means some of these firms have been suffering negatives effects of financial risks and some of them have had good conditions of controlling risks.

**Table 2: Pearson correlation matrix**

The sample includes of firms covered by 47 listed companies in Construction sector in Vietnam between 2009 and 2015. The detailed definitions of variables are described in Appendix. The symbol (\*) is for significance at the 5% level or better.

	tobinq	roe	bep	age	zz	df1	de	khttn	knttth	Size
tobinq	1.0000									
roe	0.0415	1.0000								
bep	0.0824	0.3886*	1.0000							
age	-0.1029*	0.0921*	0.0093	1.0000						
zz	0.2723*	0.1276*	0.5454*	-0.0705	1.0000					
df1	-0.0644	-0.0202	-0.0252	0.0726	-0.0361	1.0000				
de	-0.0347	0.3532*	-0.0171	0.0928*	-0.1483*	-0.0178	1.0000			
khttn	-0.0350	-0.0137	0.0812	-0.1391*	0.6996*	-0.0363	-0.0967*	1.0000		
knttth	-0.0789	-0.0157	0.0829	-0.1407*	0.6982*	-0.0273	-0.1043*	0.9678*	1.0000	
Size	0.2499*	-0.0095	-0.0998*	0.1622*	-0.2292*	0.0488	0.1145*	-0.2118*	-0.2356*	1.0000

Table 2 presents the Pearson correlation matrix between variables' used in the analysis. We noticed that our three dimensions of performance show a significant and positive relationship with the credit default risk, however, it seems not to work with the liquidity risk measures. We have still to check our research question in the context of environmental business thus with the presence of different elements of business.

#### 4. Results and discussion

In this section, we examine the effect of enterprise financial risks on the firm financial performance using the multivariate regression analysis in which the dependent variables are Tobin Q and Basic economic Power (BEP).

##### Baseline results

Firstly, we regress Quick/Current ratio and firm's characteristics on firm financial performance measures. The following table reports the results of our baseline regressions in equation (1).

$$\text{Performance}_{i,t} = \alpha_0 + \alpha_1 \text{Enterprise\_risk}_{i,t} + \alpha_2 \text{Controls}_{i,t} + \varepsilon_{i,t} \quad (1)$$

Table 3 presents the effects of controllable enterprise financial risks on firm financial performance using OLS

with fixed effects both on the time and firm levels from the (1). The sample consists of observations on construction sector listed firms from 2009 to 2015.

**Table 3: OLS of Firm performance with fixed effects on the time and firm level**

This table reports OLS with fixed effect on the time and firm level regression of firm financial performance. The results show the effects of liquidity ratios/Z-score and control variables on corporate performance.

The sample includes of observations on construction listed firms from 2009 to 2015. Refer to Appendix for variables definitions.

The symbols \*\*\*, \*\*, and \* are for significance at the 1%, 5% and 10% levels, respectively.

	bep_knttn (1)	bep_knttht (2)	tobin_knttht (3)	tobin_khttn (4)
age	-0.003* (-2.4)	-0.002* (-2.1)	0.020* (2.2)	0.018 (1.9)
de	0.001*** (3.7)	0.001*** (3.9)	0.002 (0.8)	0.001 (0.4)
zz	0.078*** (15.9)	0.082*** (17.0)	0.617*** (14.0)	0.571*** (12.3)
khttn	-0.039*** (-13.2)			-0.295*** (-10.9)
Size	0.015 (1.8)	0.011 (1.3)	-0.268*** (-4.0)	-0.270*** (-3.8)
tobinq	-0.040*** (-6.0)	-0.048*** (-7.2)		
knttht		-0.042*** (-14.3)	-0.326*** (-12.7)	
bep			-3.307*** (-7.2)	-2.896*** (-6.0)
_cons	-0.311 (-1.4)	-0.180 (-0.8)	7.669*** (4.4)	7.649*** (4.1)
Adjusted	0.551	0.580	0.518	0.467
R_square	329	329	329	329

Consistent with what we previously expected before, we find that firms holding less liquid assets have significantly a better performance. The coefficients are -0.039 and statistically significant at 1% for the acid test ratio in the BEP performance measure equation. Meanwhile, the coefficient of acid test ratio on the Tobin equation is -0.295 and still statistically significant at 1% level.

Table 4 shows the results from running the regression (1) as Table 3, however, we divided into two subsamples: one with the TobinQ<1 for the cases with less investment opportunity presented in columns (3), (4), (7), (8) and the other with the TobinQ>1 for the cases with more investment opportunities presented in columns (1), (2), (5), (6).

**Table 4: Robustness checks on firm financial performance**

This table reports our results in the presence of investment opportunity or not.

We divided our sample into two subsamples: One with the presence of investment opportunity (where the TobinQ >1) and the other without the presence of investment opportunity (where the TobinQ <1). We examine the impact of enterprise financial risks on the firm performance with/without presence of investment opportunity. Refer to Appendix for variables definitions.

The symbols \*\*\*, \*\* and \* mean significance at the 1%, 5% and 10% levels, respectively.

	big_tobinq~e (1)	big_tobinq~e (2)	small_tobi~e (3)	small_tobi~e (4)	big_bep_tt~e (5)	big_bep_tt~e (6)	small_bep~e (7)	small_bep~e (8)
age		0.042	0.051*	0.011***	0.011***	-0.003	-0.002	-0.001
0.001		(1.9)	(2.3)	(3.5)	(3.5)	(-1.2)	(-1.0)	(-0.5)
de		0.002	0.001	0.003*	0.002*	0.001*	0.001*	0.002**
0.002***		(0.4)	(0.2)	(2.4)	(2.1)	(2.3)	(2.1)	(3.1)
(3.4)								
zz		0.949***	0.937***	0.059***	0.049**	0.102***	0.101***	0.077***
0.080***								

(11.2)	(10.2)	(9.5)	(3.6)	(3.0)	(12.0)	(11.5)	(10.5)
kntttht 0.042***	-0.450***		-0.035***		-0.046***		-
	(-4.3)		(-3.8)		(-4.3)		(-
10.5) Size 0.024	-0.349*	-0.395**	-0.000	0.000	0.008	0.007	0.028*
	(-2.5)	(-2.7)	(-0.0)	(0.0)	(0.6)	(0.5)	(2.0)
(1.8) bep	-6.496***	-6.343***	-0.443**	-0.376**			
	(-7.0)	(-6.6)	(-3.2)	(-2.7)			
khttn		-0.440***		-0.028**		-0.047***	-0.040***
		(-3.5)		(-3.2)		(-3.8)	(-9.7)
tobinq 0.137**					-0.066***	-0.063***	-0.119**
					(-7.0)	(-6.6)	(-2.7)
3.2) _cons 0.502	9.494**	10.383**	0.545	0.520	-0.100	-0.093	-0.643
	(2.7)	(2.8)	(0.8)	(0.8)	(-0.3)	(-0.2)	(-1.7)
1.4)							
Adjusted 0.478	0.762	0.744	0.176	0.153	0.718	0.703	0.448
R_square 212	117	117	212	212	117	117	212

The negative relationship between corporate liquidity and firm performance is more pronounced among firms with less investment opportunity (TobinQ<1). The same conclusion is strongly confirmed for the Z-score as we supposed before that there would be a positive relation between Z-score and firm performance. In fact, a higher level of Z-score refers to a lower credit default risk that firm may have to face and thus better economic-financial results firms can perform.

Secondly, we regress firm performance measures (TobinQ and BEP) and firm's characteristics on firm financial risk measures. The following table reports the results of our baseline regressions in equation (2).

$$\text{Enterprise\_risk}_{i,t} = \alpha_0 + \alpha_1 \text{Performance}_{i,t} + \alpha_2 \text{Controls}_{i,t} + \varepsilon_{i,t} \quad (2)$$

**Table 5: OLS of enterprise financial risks with fixed effects on the time and firm level**

This table reports OLS with fixed effect on the time and firm level regression of enterprise financial risks. The results show the effects of firm financial risks and control variables on enterprise financial risks.

The sample includes of observations on construction listed firms from 2009 to 2015. Refer to Appendix for variables definitions.

The symbols \*\*\*, \*\*, and \* are for significance at the 1%, 5% and 10% levels, respectively.

	knttn_bep (1)	kntttht_bep (2)	zz_tttht (3)	zz_ttn (4)
tobinq	-1.024*** (-10.9)	-1.135*** (-12.7)	0.673*** (14.0)	0.621*** (12.3)
age	0.035* (2.0)	0.038* (2.3)	-0.019* (-2.0)	-0.017 (-1.8)
de	0.011* (2.1)	0.012* (2.4)	-0.008** (-2.8)	-0.007* (-2.6)
zz	1.616*** (35.3)	1.634*** (37.5)		
Size	0.190 (1.4)	0.084 (0.7)	-0.093 (-1.3)	-0.151* (-2.0)
bep	-9.814*** (-13.2)	-10.161*** (-14.3)	6.224*** (17.0)	6.105*** (15.9)
kntttht			0.511*** (37.5)	
khttn				0.507*** (35.3)
_cons	-5.602 (-1.6)	-2.270 (-0.7)	2.583 (1.4)	4.406* (2.2)



Adjusted	0.820	0.837	0.884	0.872
R_square	329	329	329	329

Table 5 shows how enterprise financial risks affect the firm performance. The negative relationship between firm liquidity risk measures and value of BEP confirmed once again show the two-way interaction between financial risks and firm financial performance. The coefficients of BEP are -9.814 (with t –statistic -13.2) and -10.161 (with t-statistic -14.3) in the function of quick ratio and current ratio, respectively. The mean Variance Inflation Factor (VIF) is below 2, suggesting that multicollinearity is not an issue in our setting. Furthermore, the coefficients of BEP in the function of Z-Score are 6.224 (with t-statistic 17.0 in the presence of current ratio) and 6.105 (t-statistic 15.9 in the presence of quick ratio). This suggests firms with a better performance are more likely to experience less financial distress since they are more profitable, present more investment opportunities.

#### Theoretical implications

Our study offers a number of contributions to the enterprise financial risk and firm financial performance literature. On one hand, our study contributes to the literature on the conceptualization and operationalisation of an impact of firm liquidity and credit default risks on the firm performance. Enterprise liquidity risk literature indicates that in order to reduce the risk presence in the firms, they may hedge their value. Nevertheless, construction sector has some characteristics which may affect differently on the relationship between firm performance and enterprise risk management. In fact, we find that the presence of high level liquid assets worsens the firms' performance in construction sector in Vietnam. On the other hand, we confirm the literature on the positive relationship between Z-Score and financial performance where a lower level of credit default risk enhances the economic-financial results of companies.

#### Industrial implications

Our study shows the impact of controllable financial risks on the firm performance in construction sector in Vietnam. On the one hand, our findings suggest construction sector firms should consider the trade-off between the benefits of being high liquid and the cost of having low economic-financial results when they decide the investment decisions. On the other hand, our study confirms a clear and significant negative impact of a high enterprise credit default risk on the economic-financial output. This is illustrates in the capital structure decisions and working capital management to reduce and/or to avoid a possible cost of financial distress in construction firms in Vietnam.

## 5. Conclusion

In summary, we examine the impact of controllable financial risks on the firm performance. We hypothesize that firms own a higher level of liquid assets may perform worse and vice versa. Meanwhile, a high level of credit default risk may hurt the economic-financial firm results.

Our findings are consistent with those expectations. Specifically, we find that the relationship between our quick ratio, currents ratios and firm performance is negative. The results are even stronger in the case of less investment opportunities. Moreover, Z-Score registered a positive impact on the firm performance which means lower level of credit default risk enhance the economic-financial output of the companies.

Overall, controllable enterprise risks have different impact expectation the business results. We will extend our analysis in other sectors in the economy to understand better the differences between the sectors in an emerging market as Vietnam.

As any empirical study, ours is potentially subject to the “usual” estimation issues such as endogeneity and proxies for both controllable enterprise risks and performance. In this study, we use the common proxies for both of them; however, we will try with alternative measures and control for the endogeneity.

### APPENDIX: VARIABLES DEFINITIONS

Variables	Definitions
<b>Dependent Variables</b>	
BEP (bep)	Basic economic power (EBIT/Total Assets).
TobinQ (tobinq)	Tobin Q {(Book value of Liabilities + Market value of Equity)/(Book value of Liabilities + Book Value of Equity)
Quick ratio (khttn)	(Current assets – Inventory)/Current Liabilities.
Current ratio (kntttht)	Current Assets/Current Liabilities.
Z-score (zz)	Z-score
<b>Other variables</b>	
Firm age (age)	Number of years since the firm listed first time
Size (Size)	Ln(Assets)
Leverage (de)	(Short-term debt + Long-term debt) / Equity

## References

- [1] Abuzar M.A. Eljelly, (2004), "Liquidity - profitability tradeoff: An empirical investigation in an emerging market", *International Journal of Commerce and Management*, Vol. 14 Iss: 2 pp. 48 – 61
- [2] Altman, Edward I., (1968), "Financial Ratios, Discriminant Analysis and the Prediction of Corporate Bankruptcy". *Journal of Finance*: 189–209.
- [3] Altman, Edward I., (2000), "Predicting Financial Distress of Companies"
- [4] Arnold, G. (2008), "Corporate financial management", Financial Times/Prentice Hall
- [5] Deloof M., (2003) "Does working capital management affect profitability of Belgian firms", *Journal of Business and Finance Accounting*, 30(1), 573-587.
- [6] Eidleman, Gregory J., (1995), "Z-Scores – A Guide to Failure Prediction". The CPA Journal Online.
- [7] Fatemi, A., Fooladi, I. 2006, "Credit Risk Management: A Survey of Practices", *Managerial Finance* Volume: 32 Issue: 3, pp. 227-233.
- [8] Freeman, MC, Cox, PR & Wright, B 2006, "Credit risk management: The use of credit derivatives by non-financial corporations", *Managerial Finance*, vol. 32, no. 9, pp. 761-773.
- [9] Gill, A., Biger, N., and Mathur, N., (2010), "The relationship between working capital management and profitability: Evidence from the United States", *International Research Journal of Finance and Economics*.23 (1), 116-167.
- [10] Hayette Gatfaoui, (2003), "Risk Disaggregation and Credit Risk Valuation in a Merton Framework", *The Journal of Risk Finance*, Vol. 4 Issue: 3, pp.27-42, <https://doi.org/10.1108/eb022964>
- [11] Kaplan, Mikes, (2012), "Managing risks: A new framework", *Havard Business Review*, June 2012
- [12] Lazaridis J., Tryfonidis, D. (2006), "Relationship between working capital management and profitability of listed companies in the Athens stock exchange", *Journal of Financial and Managerial Analysis*, 19(10), 26-35.
- [13] Mian, Santos, 2011, "Liquidity risk, maturity management and the business cycle"
- [14] Padachi, K. (2006), "Trends in working capital management and its impact on firms' performance: an analysis of Mauritian small manufacturing firms", *International Review of Business Research Papers*, 2(2), 45-58.
- [15] Shin H.H., L. Soenen, (1998), "Efficiency of working capital and corporate profitability", *Financial Practice and Education*, 8(1), 37-45.
- [16] Smith K., (1980), "Profitability versus liquidity tradeoffs in working management" in *Readings on the management of working capital*, K. Smith (ed.), St. Paul: West Publishing Company, 9(3), 549-562.

# Apply an Integrated Animosity Model to Research Customer Behavior. A Study in Vietnam towards China Food.

Tran Xuan Quynh\*

University of Economics – The University of Danang, 71 Ngu hanh son street, Danang city, 550000, Vietnam.

## ABSTRACT

Recently, the growth rate of food import value from China was recorded strongly dropping after event of east sea dispute between Vietnam and China according to the data of Vietnam General Statistics Office (2016). Klein (1998) showed that the country of origin and animosity toward a (previously or current) enemy nation affect purchase behavior of foreign products independently of each other. To assess the generalizability of this model, an empirical research was done in the context of Vietnam. So authors try to apply a integrated animosity model to test whether there really exist animosity toward Chinese among Vietnam people which is likely to affect the purchase behaviour of the food imported from China. This research integrates animosity model developed by Klein (1998) with country images to create a modified animosity model. The empirical results showed the significant effects of animosity, ethnocentrism and country image on attitude and purchase intentions. Study implications and suggestions for future research are also discussed.

**Keywords:** country image, animosity, ethnocentrism, China, Vietnam.

## 1. Introduction

Differences in cultural, political and economic factors (Buckley & Ghauri, 2004) have made it difficult for multinational enterprises to gain the benefits of a fully integrated global strategy as well as challenging the theories surrounding globalization (Birkinshaw & Morrison, 1995).

Thus, when a firm seeks a new export market or expands share of an existing market, it may well realize that it has been preceded by its reputation or some other more emotional factors, such as ethnocentrism and animosity, which are all-too-often ignored in the literature, can negatively influence consumer behaviour.

History of the world is full of dramatic examples of the damaging effects of hostility. From the international marketer's point of view, understanding of the possibility of animosity between nations and its effects on product purchase is important because the marketer has no choice but to deal with “country-of-origin” construct as part of the product bundle (Klein, Ettenson and Morris, 1998).

\* Corresponding author. Tel.: +84935103106  
E-mail address: quynhtx@due.edu.vn

In this context, Klein (1998) introduced the construct of animosity between nations and examined for the first time its potential impact on foreign product purchase.

There is tense relation existing between Vietnam and China about economy as well as politics during the length of history. China has always been one of the largest export partners in terms of food and clothes. Food originated China was sold at most of traditional markets in Vietnam and considered as a favourite choice of local people because of cheap price and diversity in genus. Along with this, political stresses in east sea dispute always threats on trade business between two - same border – countries.

As noted above, Vietnam and China have been in close contact with each other. Over the centuries, however, a certain degree of animosity toward China was generated. Thus, one natural question with regard to the animosity model of foreign product purchase is the generalizability of the model in Vietnam.

That is, does the animosity model work in Vietnam? If it works, what are some of the moderators that might

lesson the effects of animosity toward the exporting nation? What are practical and measurement implications of the findings?

To explore these and other issues regarding the effects of animosity on international consumer behavior, this study intends to see (1) if measurement instruments of the animosity model are valid and (2) if the animosity model works in Vietnam. Based on the findings of this study, it is also hoped that theoretical and practical implications for international marketing can be reaped.

## 2. Theory and hypotheses development

As proposed above, animosity model developed by Klein (1998) will be used as a basic model in this research. In model of Klein (1998), factors like animosity, ethnocentrism and attitude toward foreign products were used as major factors. Moreover, this research extends original model by adding country image to expand our knowledge of the relationships among animosity, ethnocentrism, country image, country image toward attitude and purchase intention.

### 2.1. Theoretical background

#### 2.1.1. Animosity

According to Averill (1982), Animosity is “a strong emotion of dislike and hatred stemming from past or present military, political, or economic aggression and actions either between nations or peoples that are perceived to be unjustifiable or as going against what is socially acceptable”. Moreover, Jung (2002) defined animosity as “a hostile attitude comprising emotion and belief components toward national out groups.

The main factors of the animosity can be represented by the war (war animosity) or by economic or diplomatic disagreement (economic animosity), linked to the fear of economic domination. Just as wars likely to lead to war animosity, trade disagreements between countries are likely to result in economic animosity (Klein & Morris, 1998)

In this study, author use animosity as major factor with two elements, which including war animosity and economic animosity. Vietnamese consumer’s animosity will be evaluated and its effects on attitude and behaviour will be tested.

#### 2.1.1. Ethnocentrism

When William G. Sumner (Robert King Merton, 1996) created the term ethnocentrism, he defined it as “the technical name for the view of things in which one's own group is the centre of everything, and all others are scaled and rated with reference to it.” It is an anthropologic concept. Robert King Merton (1996) reduces the ethnocentrism “as a social behaviour and unconsciously motivated attitude that especially bring to overestimate the racial, geographic or national group to which we belong, sometimes leading to biases regarding other peoples.”

Shimp and Shirma (1987) defined the concept of ethnocentric consumption as the sum of the beliefs which characterize consumers in terms of foreign products purchasing (in particular respect of moral principles).

Ethnocentrism is one of two major factors that proposed in animosity model of Klein (1998). Ethnocentrism is measured to test Vietnamese consumer’s priority level toward to local food and its effects on decreasing willingness of China food.

#### 2.1.2. Country of image

Country image has been recognized as a crucial marketing concept for the last four decades, since Nagashima (1970) first studied the differences between US and Japanese business – men’s attitude toward a foreign product based on country image. According to research of Nagashima (1970), country image is “the picture, the reputation, the stereotype that businessmen and consumers attach to the products of a specific country. This image is created by such variables as representative products, national characteristics, economic and political background, history and traditions”

The concept has become even more relevant as the world economy is becoming increasingly global. Generally, country image is understood as “ the total of all descriptive, inferential, and informational belief one has about particular country “(Martin & Eroglu, 1993) or “the sum of beliefs and impressions people hold about places“(Kolter & Gerner, 2002).

Country image is often studied in the literature as a multi-dimension construct with cognitive and affective measurements (Roth & Diamantopoulos, 2010). A cognitive component, which includes consumers’ beliefs about the country’s industrial development and technological advancement. An affective component that describes consumers’ affective response to the country’s people. (Laroche et al, 2005)

In animosity model, Klein (1998) only tested the direct effect of animosity on purchase intention without mentioning its effects on attitude toward foreign products. Meanwhile, not little research explored this indirect relation between animosity and attitude through country image evaluation (Gunn’s, 1972; Tasci & Gartner, 2007). Moreover,

country image have very important role in impacting consumer's attitude as buying imported products.(Knight & Calantone, 2000).

### 2.1.3. Attitude towards foreign products

Consumer behaviour intentions have been measured in various ways in consumer behaviour and marketing studies in the past. However, attitude has been one of the most widely studied subjects in predicting consumer behaviours (Terry & Hogg, 1996). Attitude is a summative evaluation of objects based on the information an individuals has about the specific objects. Food attitude has been shown as of the key influences on food choice and consumption behaviours (Rozin, 1988). Thus, attitude toward consuming a foreign product would be a major factor for measuring one's intention to try it. As individuals with a positive attitude are more likely to try the food while individuals with a negative food attitude are less likely to try it. Product attitude is commonly defined as "consumers overall evaluative judgment of a product's attributes such as style, brand and quality" (Erdogan & Uzkuurt, 2010).

## 2.2. Hypothesis development

### 2.2.1. The relationship between animosity and purchasing intention.

Klein et al., (1998) found that animosity toward a foreign nation affects negatively the purchase of products produced by that country independently of judgments of product quality. Ettenson & Klein (1999) explain the rejection of French products by Australian consumers in terms of negative emotions towards that country. Their findings show a significant direct relation between animosity and purchase intention. Nijssen (1999) also argued that consumer ethnocentrism and feelings of animosity towards a country result in reluctance to purchase a country's products. So, the first hypotheses are proposed:

**H1:** "There is a negative correlation between consumer animosity (ANI) and purchase intention (PI) towards Chinese food."

### 2.2.2. The relationship between animosity and country image.

According to Gunn's (1972) pioneer study, the image of a place may be formed through internal processes based on the individual's visit and previous experience with a place, or through external ones, by way of exposure to additional information. Additional information influencing image may be the result of promotional and other marketing activities, descriptions of the place in the media, historical or contemporary events or even the products marketed as "made in". It has also shown that after a negative event, such as political instability (Clements & Georgiou, 1998); terrorism (Coshall, 2003) or insecurity (Timothy & Duval, 2004), they also influence country image. Meanwhile, country image was considered as dimensional structure with cognitive and affective components. Cognitive component measures customer's objective evaluation towards a specific nation, affective component measures customer's subjective evaluation. Meanwhile, the cognitive factor is recorded firstly and then it will impact on consumer's affective (Beerli & Martin, 2004). Animosity also shows customer's individual feelings towards a specific nation. Hence, the two following hypotheses are offered:

**H2:** "There is a positive correlation between cognitive country image (CCI) and affective country image (ACI)".

**H3:** "There is a negative correlation between consumer animosity (ANI) and affective country image (ACI)"

### 2.2.3. The relationship between country image and attitude.

Wang et al., (2012) showed that when consumers do not have a clear product image, their cognitive country image could be used as a substitute for product image to infer product quality evaluation, leading to purchase intention.

It has been suggested that the country image is constructed "hierarchically" from cognitive to affective (Gartner, 1993). Individuals first evaluate the cognitive cues of a country, which then create emotions toward the country. Hence, the cognitive component will have an indirect effect on consumer's attitude while the affective image will have a positive direct effect on attitude (Beerli & Martin, 2004). Hence, the next hypotheses is proposed:

**H4:** "There is a positive correlation between affective country image (ACI) and attitude towards China food (ATT)".

### 2.2.4. The relationship between ethnocentrism and purchasing intention

Klein (1998) revealed that the affecting mechanism between consumer ethnocentrism and purchase intention. The consumers with higher consumer ethnocentrism have better attitude toward domestic products. When consumers have positive product attitude, it means that they judge the products better and have stronger purchase intention.

Klein and Ettensoe (1999) suggest that consumer ethnocentrism contributes to a consumer's propensity to avoid

buying foreign products in general. So, two hypotheses are proposed as following

**H5:** “There is negative correlation between ethnocentrism (ETH) and attitude towards China food (ATT)”

**H6:** “There is negative correlation between ethnocentrism (ETH) and purchase intention (PI) towards China food”

2.2.5. The relationship between attitude and purchasing intention

Attitude in relation to food has been found to be an important influence on one’s food choice and food related behaviours (Rozin, 1988). Another research conducted by Jaafar, Lalp and Mohamed, 2007 about effects of perceptions and attitude on purchase intention toward private label food products in Malaysia; they revealed that the most significant factor that influencing consumers ‘s purchase intention toward private label food are consumers ‘s attitude and perceived price. The past studies pointed the role of consumers’s attitude in purchase process in various fields. Therefore, the next hypothesis is proposed:

**H7:** “There is a positive correlation between consumer’s attitude (ATT) and purchase intention (PI) towards China food.”

**3. Research method**

Based on extant literature, framework is proposed as Figure 1. In this research, a total of 45 items was used to measure the factor of structure like country image, animosity, ethnocentrism and attitude and purchase intention. Pre – test was then conducted with 30 respondents in Vietnam. Based on the pre - test result, 4 items were deleted and some items were modified to ensure a clear statement. Final questionnaire included 41 closed – ended questions that measured by Likers 5 points.

Meanwhile, animosity is measured by 10 items about war animosity and economic animosity (adopted from Klein et al., 1998). 6 items for cognitive country image (Orbaiz and Papadopoulos, 2003) and 7 items for affective country image (Papadopoulos et al., 1998; Echtner & Ritchie,1993). 6 items were used in purchase intention scale and 4 items for attitude. Finally, consumer ethnocentrism were measured by 10 items adopted from the CETSCALE by Shimp and Sharma, 1987. See the appendix.

Survey was collected from 586 respondents distributed in three main locations, including: Ha Noi capital, Da Nang, Quang Nam and Ho Chi Minh City. The data was collected from March to June, 2017 by delivering questionnaire directly as well as using online form. The sample comprised of 204 male, 382 female. Their age ranged between 18 and 50. Some other information like mean of measurements, location of respondents were presented in table 1.

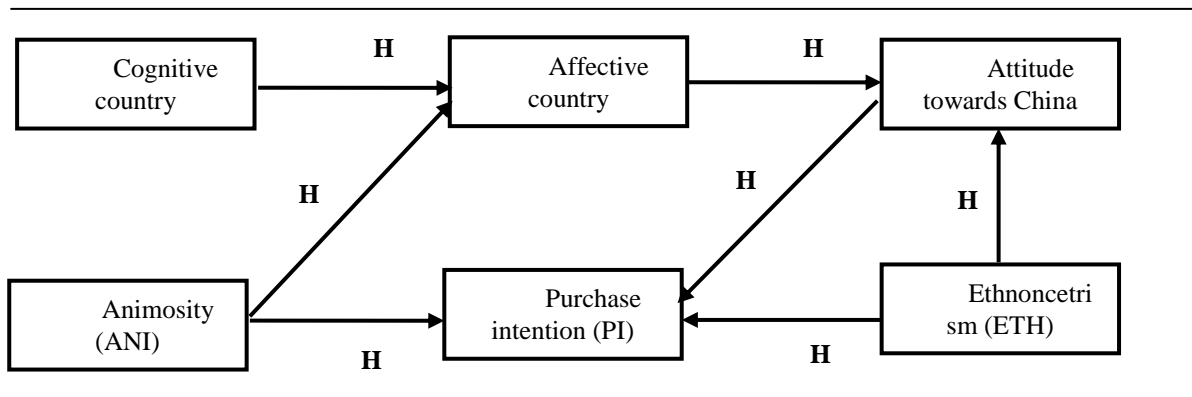

**Figure 1. The framework**

**Table 1. Results of demographic statistics**

Factors	Mean	Number of items
Animosity	<b>3.113</b>	10
Cognitive country image	3.235	6
Affective country image	2.375	7
Ethnocentrism	<b>3.785</b>	8
Attitude towards China food	2.675	4
Purchase intentions	1.895	6
Age	Distribution	

18-22		14.7%
22-25		54.3%
25-30		26.6%
Over 30		4.4%
Location	Value	Percent (%)
Ha Noi capital	168	28.6
Da Nang, Quang Nam	289	49.3
Ho Chi Minh city	129	22.1
<b>Total</b>	<b>586</b>	<b>100</b>

#### 4. Results and discussions

##### 4.1. Confirmatory Factor Analysis for model

In order to assess model fit of measurement model, confirmatory factor analysis is used to test for two - single constructs (exogenous group and endogenous group) in advance and full construct, then. Group of exogenous latent variables includes cognitive country image, animosity and ethnocentrism. Group of endogenous latent variables includes affective country image, attitude and purchase intention. In the procurement of analysis, factor loadings of items lower than 0.6 will be deleted and some items are also removed to increase the fit indices of constructs. Results indicated that 18 items are deleted, including: ETH5, ETH6, ETH7, ETH9, ETH10, ANI1, ANI2, ANI4, ANI9, ANI10, CCI2, ACI2, ACI5, ACI7, ATT3, PI1, PI3, PI4. The final results of CFA are presented in table 2. Basically, fit indices of two - single construct are good level. Although, the indices of full measurement model are lower than suggested value, all of them are accepted.

**Table 2. Results of Construct Measurement Model**

Construct	Cmin/df	RMSEA	GFI	AGFI	CFI	NFI
Benchmark value	≤3	≤0.08	≥0.9	≥0.8	≥0.9	≥0.9
Exogenous group	2.594	0.074	0.926	0.891	0.938	0.903
Endogenous group	2.156	0.063	0.955	0.923	0.971	0.948
Full measurement model	2.437	0.070	0.842	0.805	0.885	0.821

##### 4.2. Reliability and validity of model:

To check validity of model, convergent and discriminant validity will be evaluated. Convergent validity is satisfied as Average variance extracted (AVE) is higher than 0.5 (Merrilees et al., 2009). Discriminant validity is satisfied as the square root of each construct's AVE is larger than its correlations with other constructs (Chin, 1998). To conduct the reliability of model, Composite Reliability (CR) is the tool that was used to check (Werts et al., 1974). CR value above 0.7 is good for confirmatory purpose.

The results showed that all AVEs of each construct are higher than 0.5; CR are greater than 0.7 and square root of each construct's AVE is larger than its correlations with other constructs. It can be concluded that model satisfies about reliability, convergent and discriminant validity.

**Table 3. Results of CR, AVE and Correlation Matrix for Principal Construct.**

	CR (>0.7)	AVE (>0.5)	ANI	CCI	ACI	ATT	ETH	PI
ANI	<b>0.862</b>	<b>0.556</b>	<b>0.746</b>					
CCI	<b>0.857</b>	<b>0.502</b>	0.025	<b>0.709</b>				
ACI	<b>0.862</b>	<b>0.612</b>	0.129	0.315	<b>0.782</b>			
ATT	<b>0.844</b>	<b>0.645</b>	0.043	0.036	0.160	<b>0.803</b>		
ETH	<b>0.842</b>	<b>0.521</b>	0.310	0.264	0.057	0.165	<b>0.722</b>	
PI	<b>0.798</b>	<b>0.568</b>	0.135	0.020	0.0293	0.555	0.297	<b>0.754</b>

**Note:** This table 3 shows the square root of AVE in the diagonal blanks (in bold)

#### 4.3. Results of structure equation model

The results of the structural equation analysis are shown in Figure 2. The model achieved a good level of fit: CMIN/df = 2.345, GFI = 0.868, AGFI = 0.834, CFI = 0.904, RMSEA = 0.068, p-value = 0.000. Overall, purchase intention factor was explained approximately 36% by the model as a whole.

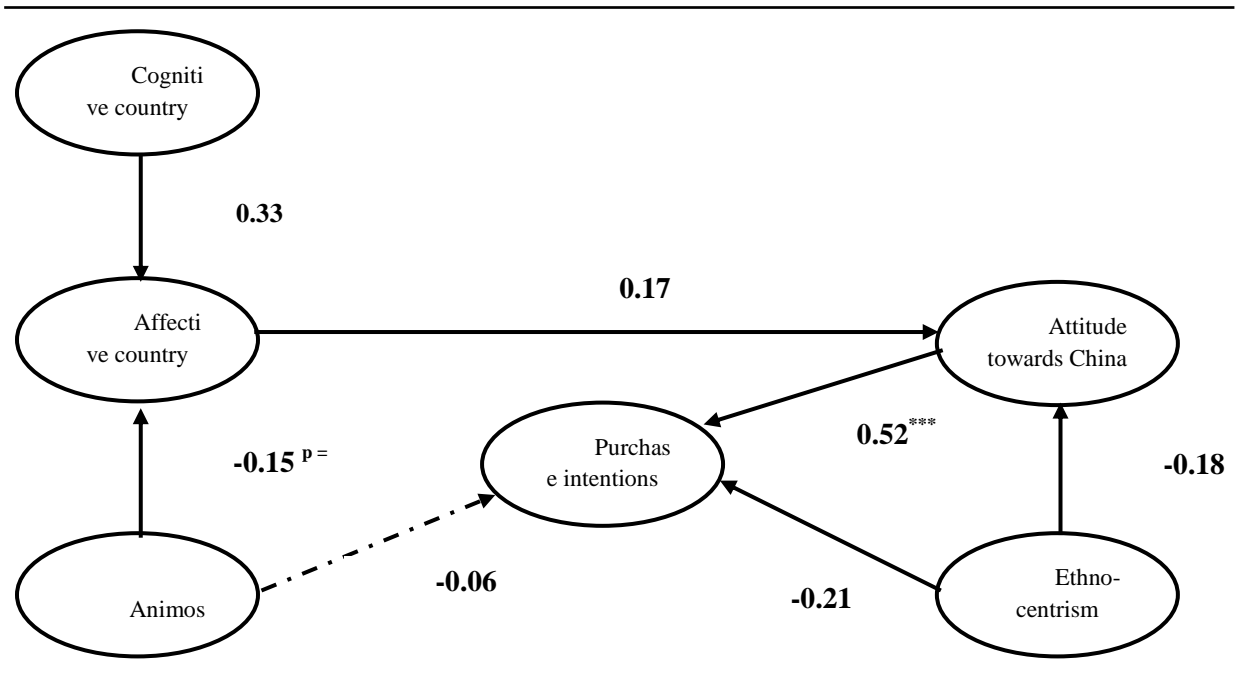

**Figure 2. Structural Equation Model Results**

The final findings showed that six proposed hypotheses were supported and one hypothesis was rejected. As predicted in H2, the path from cognitive country image to affective country image was significant and positive ( path coefficient = 0.33, p – value = 0.000). The findings also supports H3, negative relation between animosity and affective country image with its coefficient = -0.15, p – value = 0.024. As predicted in H4, the positive effects of affective country image on attitudes towards China foods was significant (path coefficient = 0.17, p – value = 0.012). The results support for H5 and H6, consumer ethnocentrism was a significant negative predictor of both attitude towards foreign products and purchase intentions (Coe<sub>h5</sub> = -0.18, p<sub>h5</sub> = 0.008; Coe<sub>h6</sub> = -0.21, p<sub>h6</sub> = 0.002). The high level of model fit demonstrate support for H7 because of positive relation between product evaluation and purchase intentions with its coefficient = 0.52, p - value = 0.000. But the findings rejected H1, path from consumer’s animosity to purchase intentions with p – value = 0.375 > 0.05.

#### 4.4. Discussion:

One of the most important purpose of this study is to test whether there really exists animosity and ethnocentrism among Vietnamese people towards consumption of Chinese food. According to te result of descriptive statistics, it revealed that Vietnamese people have both animosity towards China and ethnocentrism towards local products as their average value are greater than 3 point (3.113 and 3.785 in table 1).

Consumer ethnocentrism is recorded with high point approximately 3.785 among respondents. It means that most of the Vietnamese people have a more priority towards local products than products imported Chinese market. This findings are consistent with previous studies about consumer ethnocentrism among Vietnamese people towards various products like medicine and foods.

Customer animosity is recognized existing among Vietnamese people in spite of low level which is not consistent with author’s early expectation. It is very exciting to know that in spite of disputes about policy and economy between Vietnam and China, a large part of respondents still have positive attitude towards Chinese people. In the short interview conducted in collecting process, respondents represent an independent and distinct attitude between China government and Chinese people as they explained that such disputes almost origin from China government and not related to Chinese people. This can be considered as a significant reason to explain about the point level of customer animosity among Vietnamese people.



The analysis findings are consistent with the results conducted by the researchers in the past (Klein, 1999; Kaynak, 2002) except from effects of animosity on purchase intention (Cai et al., 2012). Although animosity still exists in customer evaluation, this however does not directly influence on purchase intention towards China food.

Attitude towards foreign products and ethnocentrism recorded large effect level on changes of behaviour (coe = 0.52 and -0.21, respectively). They are also consistent with the research about the impact of attitude and ethnocentrism on foreign products.

The findings also confirmed the effects of Cognitive country image on Affective country image as well as the indirect effects of Ethnocentrism on Purchase intention through Attitude. The key findings in this model are the negative impact between Animosity and Affective country image that recorded as a critical contribution in author's research. No lots of researches mentioned about this problem before.

Changes of customer behaviour was explained about 36 % by the rest of factors in research model. It means that the increasing in animosity, ethnocentrism level will result to the decrease in attitude towards imported products and it leads to strongly drop about shopping behaviour towards China food.

## 5. Contributions and implications:

Contribution: Author's findings delivers meaningful contributions in reality and academic field. In their study, Klein et al. (1998) did not indicate the indirect effects of animosity on attitude. They focused the effects of animosity and ethnocentrism on purchase intentions. Likewise, not lots of researches indicated significant correlation between animosity and affective country image in the past. Moreover, relationship between animosity and purchase intention existed in animosity model (Klein, 1998); in contrast, hypothesis is not supported in this study. It is considered as a controversial problem and it can be explained by slow animosity level that existing Vietnamese people. Therefore, country image keeps an important role in applying animosity model in the case of Vietnam by indirect effects of animosity on purchase intention.

Implication in marketing mix: The findings also recorded the positive effects of country image on attitude that leads increasing in purchase intentions. It means that country image was considered as an important aspect in promoting and advertising about the foreign products. This is a useful lesson that international marketers should consider in the global market.

Future suggestions: attitude towards foreign products is a key context of international marketing in present. The continous researches need to focus on explanation such factor in the market of Vietnam towards not only China products but also foreign products generally.

### APPENDIX.

#### LIST OF ITEMS

##### ANIMOSITY.

We feel angry toward the Chinese

We will never forgive the Chinese for what they did in the past

The Chinese should pay for what they did in the past

We dislike the Chinese

We feel antipathy towards the Chinese

We avoid the Chinese whenever possible

We have aversion to anything linked to the Chinese

China is not a reliable trading partner

China has too much economic influence in Vietnam

10.China is doing business unfairly with Vietnam.

##### COGNITIVE COUNTRY IMAGE.

China has high quality of life

China has a good economy

China is a country with rich people

China has high technology level

China has a good education

China is a modern country

##### AFFECTIVE COUNTRY IMAGE

The Chinese are friendly

China is a safe country

The Chinese are trustworthy

The Chinese are pleasant

The Chinese people are hard working

The Chinese are likeable

The Chinese are creative

##### ATTITUDE

Food imported from China are so diverse  
 Packages of China are designed beautifully  
 Food imported from China are reliable about quality  
 Food imported from China are a good value for the money  
 Food imported from China are suitable about price  
 Food imported from China assure about food safety.

**PURCHASE INTENTION**

I would feel guilt if I bought a Chinese food  
 Whenever possible, I avoid buying Chinese food  
 I reject the possibility of buying Chinese food  
 I like the idea of owning Chinese food  
 I am willing to buy Chinese food  
 I will consider buying Chinese food

**ETHNOCENTRISM**

Vietnamese people should always buy Vietnam food instead of import from China  
 Only food that are unavailable in Vietnam should be import from China  
 Buy Vietnam food, keep Vietnamese people working  
 We should purchase Vietnam food instead of letting China get rich off us.  
 It is always best to purchase Vietnam food  
 There should be very little trading or purchasing of goods from China unless out of necessity.  
 Vietnamese people should not buy China food, because this hurts Vietnam business and causes unemployment.  
 China traders should be allowed to put their products on our markets  
 China food should be taxed heavily to reduce their entry to Vietnam market  
 10. We should buy from China only those food that we can not plant in our country.

**References**

- [1] Aaij & Van Beuzekom, M. (2010). Measurement of at in the forward region. *Physics Letters B*, 694(3), 209-216.
- [2] Averill, J. R. (1982). Anger and aggression: An essay on emotion.
- [3] Beerli, A., & Martin, J. D. (2004). Factors influencing destination image. *Annals of tourism research*, 31(3), 657-681.
- [4] Birkinshaw, J. M., & Morrison, A. J. (1995). Configurations of strategy and structure in subsidiaries of multinational corporations. *Journal of international business studies*, 729-753.
- [5] Buckley, P. J., & Ghauri, P. N. (2004). Globalisation, economic geography and the strategy of multinational enterprises. *Journal of International Business Studies*, 35(2), 81-98.
- [6] Cai & Song, H. (2012). Implicit Consumer Animosity: A Primary Validation 1. *Journal of Applied Social Psychology*, 42(7), 1651-1674.
- [7] Clements, M. A., & Georgiou, A. (1998). The impact of political instability on a fragile tourism product. *Tourism Management*, 19(3), 283-288.
- [8] Coshall, J. T. (2003). The threat of terrorism as an intervention on international travel flows. *Journal of Travel Research*, 42(1), 4-12.
- [9] Dennis, C., Merrilees, B., Jayawardhena, C., & Tiu Wright, L. (2009). E-consumer behaviour. *European Journal of Marketing*, 43(9/10), 1121-1139.
- [10] Diamantopoulos, A., & Zeugner-Roth, K. P. (2010). "Country of Origin" as Brand Element. *Wiley international encyclopaedia of marketing*.
- [11] Echtner, C. M., & Ritchie, J. B. (1993). The measurement of destination image: An empirical assessment. *Journal of travel research*, 31(4), 3-13.
- [12] Elliott, G. R., & Cameron, R. C. (1994). Consumer perception of product quality and the country-of-origin effect. *Journal of International Marketing*, 49-62.
- [13] Gartner, W. B. (1993). Words lead to deeds: Towards an organizational emergence vocabulary. *Journal of business venturing*, 8(3), 231-239.
- [14] Ginn, Tasci, A. D., & Gartner, W. C. (2007). Destination image and its functional relationships. *Journal of travel research*, 45(4), 413-425.
- [15] Gunn, C. (1972). *Vacation scape: Designing Tourist Regions*. Austin: Bureau of Business Research: University of Texas.
- [16] Hall, C. M., Timothy, D. J., & Duval, D. T. (2004). Security and tourism: towards a new understanding. *Journal of Travel & Tourism Marketing*, 15(2-3), 1-18.
- [17] Herche, J. (1992). A note on the predictive validity of the CETSCALE. *Journal of the Academy of Marketing Science*, 20(3), 261-264.
- [18] Jung, B., A. (2002). Consumers 'attitude towards imported food products. *Food quality and Preference*, 9(6), 431

– 441.

- [19] Kaynak, E. and Kara, A. (2002). Consumer perceptions of foreign products: An analysis of product-country images and ethnocentrism. *European Journal of Marketing*, 36:7/8, pp. 928-949.
- [20] Kaynak, E., & Cavusgil, S. T. (1983). Consumer attitude towards products of foreign origin: do they vary across product classes. *International Journal of Advertising*, 2(2), 147-157.
- [21] Klein, J. G., & Ettenson, R. (1999). Consumer animosity and consumer ethnocentrism: An analysis of unique antecedents. *Journal of International Consumer Marketing*, 11(4), 5-24.
- [22] Klein, J. G., Ettenson, R., & Morris, M. D. (1998). The animosity model of foreign product purchase: An empirical test in the People's Republic of China. *The Journal of Marketing*, 89-100.
- [23] Knight, G. A., & Calantone, R. J. (2000). A flexible model of consumer country-of-origin perceptions: A cross-cultural investigation. *International Marketing Review*, 17(2), 127-145.
- [24] Kotler, P., & Gertner, D. (2004). Country as brand, product and beyond: a place marketing and brand management perspective. *Destination branding: Creating the unique destination proposition*, 2, 40-56.
- [25] Laroche, M., Papadopoulos & Mourali, M. (2005). The influence of country image structure on consumer evaluations of foreign products. *International Marketing Review*, 22(1), 96-115.
- [26] Martin, I. M. – Eroglu, S. (1993): Measuring a Multi Dimensional Construct: Country Image. *Journal of Business Research*, 28, p.193.
- [27] Nagashima, A. (1970): A Comparison of Japanese and U.S. Attitude toward Foreign Products. *Journal of Marketing*, Vol.34, January, pp.6874.
- [28] Nijssen, E. J. (1999). Success factors of line extensions of fast-moving consumer goods. *European Journal of Marketing*, 33(5/6), 450-474.
- [29] Orbaiz, L. V., & Papadopoulos, N. (2003). Toward a model of consumer receptivity of foreign and domestic products. *Journal of International Consumer Marketing*, 15(3), 101-126.
- [30] Papadopoulos, G. A., & Arbab, F. (1998). Coordination models and languages. *Advances in computers*, 46, 329-400.
- [31] Robert K. Merton (1996). A Modern Sociological Classic. *Journal of Classical Sociology*. 7: 131-136
- [32] Rozin, P., & Fallon, A. (1988). Body image, attitude to weight, and misperceptions of figure preferences of the opposite sex: A comparison of men and women in two generations. *Journal of Abnormal Psychology*, 97(3), 342.
- [33] Shimp, T. A., & Sharma, S. (1987). Consumer ethnocentrism: construction and validation of the CETSCALE. *Journal of marketing research*, 280-289.
- [34] Terry, D. J., & Hogg, M. A. (1996). Group norms and the attitude-behaviour relationship: A role for group identification. *Personality and Social Psychology Bulletin*, 22(8), 776-793.
- [35] Vietnam General Statistics Office (2016)
- [36] Werts, C. E., Linn, R. L., & Jöreskog, K. G. (1974). Infraclass reliability estimates: Testing structural assumptions. *Educational and Psychological measurement*, 34(1), 25-33.
- [37] Zafer Erdogan, B., & Uzkuurt, C. (2010). Effects of ethnocentric tendency on consumers' perception of product attitudes for foreign and domestic products. *Cross Cultural Management: An International Journal*, 17(4), 393-406.
- [38] Zafer Erdogan, B., & Uzkuurt, C. (2010). Effects of ethnocentric tendency on consumers' perception of product attitude for foreign and domestic products. *Cross Cultural Management: An International Journal*, 17(4), 393-406.

# Determinants of Employee Work Innovation: Critically Review and Integrated Model

Pham Hong Liem\*

University of Khanh Hoa, 1 Nguyễn Chánh Str., Nha Trang City, Khanh Hoa Province, Viet Nam.  
PhD candidate, University of Economics - The University of Da Nang

## ABSTRACT

This study is to systematically reviews and integrates research that has examined the factors that influence employee work innovation. The study is based on more than 70 articles published by magazines in the fields of business, management, marketing, and behaviour throughout the world nearly the past three decades. Such factors have been categorized into organizational, team, job, and individual. Next, the author mentions possible determinants of employee's innovation that have received little research attention, present a new research direction for theory building. Psychological capital and brand supporting behaviour, job design, corporate social responsibility (CSR) and organizational climate have been identified as individual, job and organizational factors, in turn. This is also the proposed theoretical framework to provide holistic view of various factors that influence employee work innovation. The result of this paper has important HR and political implications for managers and policy makers to better foster organizational innovation..

**Keywords:** Work innovation; CSR; psychological capital; brand; climate.

## 1. Introduction

This is the time for Vietnamese businesses to innovate in line with the general trend of integration. Because, today's consumers with more choices but less satisfaction [54] will be attracted by more diverse products and services to better satisfy their needs. Innovation is seen as the right solution to balance the interests of customers and service providers.

Encouraging employee's innovation is one of the ways that organizations respond to expectations and expand employee autonomy, give them the opportunity to express themselves, control the work and improve the performance of the organization [40]. This is considered a way to help businesses deal with their difficulties and challenges. One of the major challenges now is the rapid and large-scale change of the business environment, creating psychological pressure for both businesses and employees to adapt and accept risk [20]. To compete in that uncertainty, businesses always asked employees to be innovative in work place by creating new and suitable ideas for products or processes [60].

## 2. Method

The study is based on more than 70 papers published over the past three decades by business, management, marketing and behavioral magazines. The search and collection of related papers starts with a review of the most recent published research on employee's innovation in the workplace, based on scientific databases, using keywords: Innovation, Innovative work behaviour, and creativity. The abstract of each paper is prioritized for verification to verify and select articles that are most relevant to the topic of study. Materials such as books or research reports are also considered. Furthermore, the selection of articles is also not limited by the measures used for innovation: self-staff or through third-party. Articles with duplicate content are removed. The next results are grouped and categorized into groups of similarities.

\* Corresponding author. Tel.: +84 987692279.  
E-mail address: phamhongliem@ukh.edu.vn

### 3. Results

#### 3.1. Definition of work innovation

Innovation has been defined by various authors and expresses some important aspects of it, but all emphasize “novelty” as the core of innovation. Most definitions of innovation involve the development and implementation of new ideas. Innovation is defined “as the development and implementation of new ideas by people who over time engage in transaction with others within an institutional order” [73:591]. In more detail, Scott & Bruce defined innovation as “a multistage process, with different activities and different individual behaviors necessary at each stage” [59:582]. And according to Amabile, innovation is “the successful implementation of creative ideas within an organization” [2:1].

Although innovation is a multi-stage process, it is characterized by real activities. Therefore, employees may participate in the innovation process at any stage and at any time.

#### 3.2. Determinants of employee work innovation

##### 3.2.1. Organizational label factors

Employee work innovation, considered from the behavioural perspective as innovative work behaviour, is seen as an important factor to increase the effectiveness of organizational innovation performance [16,32,59]. The next section evaluates the organizational, team, job, and individual label factors that influence the innovation of employees in the organization.

First of all, that's the organizational strategy. It's a strategy where innovation is first and foremost emphasized [82], a long-term goal-setting strategy, accepting initial difficulties, as well as allowing employees to learn from work and from failures [43,72]. In addition, strategic co-operation and connecting with customers are also key drivers of creativity and innovation [50].

Organizational structure is also a key factor for the success of organizational innovation. It is a clear structure of function, flexibility, and adaptability [72], and the coordination of activities of the members [58]. In contrast, an organizational structure characterized by bureaucracy, formalization and rigid principles would be a barrier to innovation processes [14]. As the business environment is variable and difficult to predict, the organic organization structure is considered appropriate for creating a climate and culture that encourages employee work innovation [45,72].

Studies have also shown the indispensable role of organizational culture in creating the basis for stimulating innovation [44,72]. A culture with innovation drivers will foster a firm-wide recognition of the necessity to innovate [65]. More concretely, dimensions such as high autonomy, tolerance of and not afraid of mistakes, and continuous learning [44,51], equality in the exchange of information, as well as honest publicity of feedback [6,26,77] and fairness in distribution [63] are some of the most prevalent characteristics of innovative culture.

In addition, accepting cultural diversity and respecting individual differences, as well as increasing connectivity within organizations, is the foundation of organizational culture, thereby forming an environment for innovation [43,72]. Noor & Dzulkifli [47] have shown the effect of organizational climate on internal motivation motivating employees to innovate. That climate is psychological safe, proactive supporting and supporting for innovation [7]. Moreover, when workers feel the concern of their colleagues, they will have a safe psychology, thereby creating motivation for innovation in the workplace [75] and effort to complete the work more than expected [44].

The important factor that can have a significant impact on the employees' creativity and innovation is the leadership style. It is a democratic leadership style, respecting the employees' opinions in the decision-making process [17], always engage with employees, create connections, increase communication between managers and subordinates, thereby adjusting and changing the values and beliefs of employees in accordance with organizational values [57]. However, Basu & Green [6] argues that transformational leadership under certain circumstances deters innovation.

##### 3.2.2. Team label factors

The characteristics and tasks of the team have a positive influence on the innovation of the workers [76, 82]. The team members' coordinating and working together on a project that is seen as a mechanism for increasing employee innovation [3, 31]. The existing research findings indicate team composition plays an important role in creating and promoting innovation based on the diversity of workers' skills and knowledge [35, 64, 76].

Diversity, however, can easily cause communication problems, stress and conflict among team members, thus threatening the environment of psychological safety and integration. Therefore, diversity can also have a negative impact on innovation, if it threatens the team's safety and integration [35, 71].

Researchers have also emphasized the role of social relations, trust and fairness in promoting innovation. Scott & Bruce [59] have suggested that positive interactions and the quality of team member exchange relationships play a central role in supporting innovation. Specifically, goals of the team and interdependency in team members' work create interpersonal connectivity, and contribute to the member's ability to produce innovative results [71]. Fairness

contributes to reducing uncertainty, which often surrounds innovativeness [33], reduces conflicts among members, solves all problems, and works together for the common goal [68]. When hotel staff interacts with and act together for the reputation of the team, it creates innovative behaviors and services [15, 30].

### 3.2.3. Job label factors

Specific tasks and jobs plays an important role in influencing employee's decision whether or not to involve in the innovation process, partially through motivating employees [1,74]. That is, the job is designed to require employees to have control and appropriate working methods [18,28], and the contextual characteristics of the work [48] that have influence an employee work innovation.

Autonomy in the workplace has probably received the most attention in innovation research [60,61]. Especially in the context of high conflict between individuals, the higher the autonomy, the more it promotes employee innovation [27]. Besides, The more complex and demanding workers' jobs, the more effort they have to work and look at the various solutions to solve [7,60]. The job challenges also motivate employees' creativity to achieve better results [32,49]. Innovative behavior can also start from employee dissatisfaction with the current situation, and innovation is a requirement of the job. Then, they will make effort to improve the situation, and to achieve better results [82]. But too much challenge may cause over-stimulation, exhaustion and stress, thereby overwhelming the employee and killing creativity [14,76].

### 3.2.4. Individual label factors

Humans are one of the organization's main resources. Therefore, there are many studies that are concerned with the influence of personality or person-specific on employee innovation. In his study, Feist [21] suggested that creative individuals are high in confident, autonomy, impulsive, dominant, ambitious, hostile, extravert and open to new experiences. Personality traits as consistency with criticism or judgment, and confidence are also common characteristics of creative employees [1,25,29]. Flexibility and a preference for a change and novelty [12,34,44] and self-esteem [56] are also mentioned by scholars in several studies.

Openness to new experiences and extraversion has been consistent personality characteristics among more creative employees [79]. Those who are willing to work on new ideas, curiosity, exploration of the world and others inner ideas [23,55]. Furthermore, openness is an important moderate factor in the process of employees' innovation. In addition, openness combined with high-activated positive mood creates a powerful resonance for innovation [26,42]. Employee's proactive behavior is also mentioned in innovation studies, including self-initiated actions, changes and improvements in the current situation [52], as well as the skills, proactiveness in adjusting attitudes and behavior to achieve desired results [11]. Studies also highlight the importance of individual internal force for innovation. That is because, employees also need to have certain internal force to be able to persevere in the face of troubles or challenges in the innovation [12,60,82].

Besides, in order to successfully innovate, the skills, abilities and personality that are required from employees in contemporary organizations include those related to connecting [4], learning skills [12], knowledge and wisdom [7], creative thinking, multi-dimensional thinking, forming alternative alternatives [34,60,74], personal approach [67], and positive emotions [78].

The above review has introduced the label factors that affect the innovation of employees. This is a considerable knowledge base. However, there are several issues that still need to be discussed.

First, most studies conducted only on single-level analysis in their proposed theoretical models (e.g. organization or individual), thus ignoring the complex and process-nature of innovation [3]. For example, an organizational culture that supports learning, and creating psychological safety in the team can positively influence the risk-taking of employees in innovation. In turn, these innovative activities are reflected in the performance of the team and the organization. Therefore, researches should provide a more general view of the factors that influence innovation: Employee work innovation is not only enhanced by single factors such as individuals, job or organizational characteristics but also by the interaction of those factors.

Second, for businesses today, social responsibility is not only "the right thing to do" but also "the smart thing to do" [66:60]. The more the business contributes to society, the better the reputation of the business [8], the more contributing to the competitive advantage of the business [22]. The efforts of the service staff to meet the diverse customer's needs create working pressure for them, leading to stress, exhaustion and rest [53]. Therefore, employees need to balance their workplace morale, in order to provide consumers with the best possible service. This also implies that the next study should address the role of CSR, the working environment, as well as the psychology of the worker.

Finally, the discovery of the factors that influence employee work innovation is necessary, but we need to better understand the role of each of these factors in the innovation process. From that, there are practical suggestions for managers in the innovation strategy.

### 3.3. Integrated model of innovation

Innovation is an important subject of research in tourism. The tourism sector recognizes increasing competition worldwide, not only between destinations but also between firms within the destinations [19,70]. With the ability to offer differentiated products and services, innovative hotels are more successful than non-innovative competitors. In service, employee work innovation is the result of interaction with the customer [29]. In the process, employees should behave in accordance with customer's requests or feedbacks. And employee brand-supporting behaviour is evident to the customer to assess the quality of hotel service [38]. The studies also show the role of brand-supporting behaviour in positively influencing the hotel brand [10], and are the basis for better employee performance [5,69]. To make a difference, the accommodations always have specific standards to form a style of their own specific service, and they need employees who are not only good at the job but also have confidence in the job, have the optimism to serve the client better, know how to stand up after failure, and have motivation to complete goal. These are the employees who have high psychological capital. Employees will work harder, and have a safe work environment, have the opportunity to develop their career, develop their own capacity, if they have a psychological capital [41,46]. Studies (e.g. [39]) also point out that, employees with high self-esteem are creative and tend to develop into innovative behaviors. In addition, knowledge sharing, as well as interpersonal interactions among employees, also increases the behavior and capacity for innovation of workers in general [80], and in the service sector in particular [30].

Many factors have been consistently found to be facilitators of innovation at differing levels of analysis. These are organizational, team, job, and individual level factors. However, there is a small body of research that focuses on environmental factors. Environmental factors also contribute to employee individuality. When employees work in an organization where they are recognized and rewarded appropriately, trained and developed, and confident, it will stimulate and motivate them to share their knowledge with colleagues [37], as well as increase the satisfaction and commitment to the organization, develop their own capacity, thereby improving the efficiency of the work of employees [41,62]. Therefore, the innovative process can progress steadily, organizations need to shape and develop an environment in which employees' creativity is encouraged to thrive and be realized through their actions. From there, spread organizational brand image to the customer. However, Basu & Green [6] also notes that, the lack of a relationship between autonomy and innovative behaviors can perhaps be attributed to the work environment. To the extent that followers could not vary their work, their opportunities for stumbling upon new ways of doing things or willfully trying out new ideas are likely to be limited.

Two important components that affect customer's perception of a company's products are the company's ability and CSR [9]. The influence of CSR on employee behavior in the organization has also been mentioned by scholars. These are positive influences on the behavior and behavior of employees (e.g. [13,36,81]).

Employee work innovation is directly affected by the nature of work [32,59]. And effective job design has become one of the most prominent aspects of human resource management, organizational behavior, as well as to survive in the global business environment [24]. Employees will be motivated to engage in innovative activities as they perform tasks designed to create flexibility for employees [18], employees control their work, as well as be confidently asked to solve problems that arise [28].

Based on the presented theoretical analysis, theoretical model of innovation in the workplace of employees is shown in Figure 1.

**Figure 1. Theoretical model of work innovation of employee in hospitality industry.**

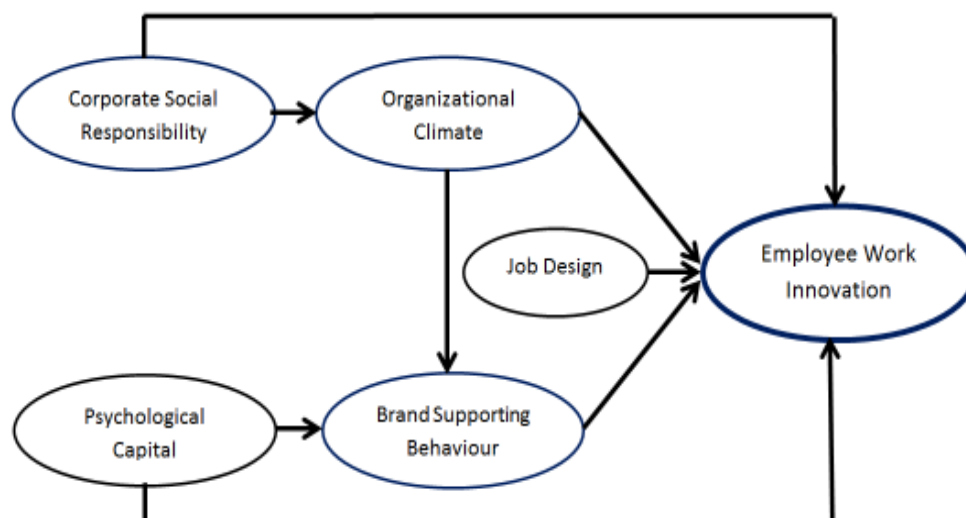

#### 4. Conclusion

This article provides a holistic picture of the key factors that influence employee innovation in the workplace. From the in-depth review of past studies on employee work innovation, it can be concluded that framework to measure the employee work innovation is organizational, team, job and individual label factors. To achieve a comprehensive understanding of innovation, we need to look at the relationship between the various factors, as well as the relationship between the individual, the team, the job, and the organization. Individual innovation can be affected by the environment of the team, as well as organizational climate. And in turn, innovation also contributes to the organizational culture, and the working environment of the team. Therefore, the employee work innovation is a complex process, as a result of the connections of the elements together.

This study has contributed to providing a holistic view of the factors that play an important role for employee work innovation, as mentioned in previous studies. The integrated framework presented here portrays the linkages among cross-level factors related to employee work innovation. To achieve a comprehensive understanding of employee work innovation, managers need to look at the correlation between the different factors, such as the relationship between the individual, job, team, and organizational label factors. Such an understanding may facilitate evolving better plans and making rational decisions of managers, as well as creating innovative climate and exploiting innovative potential of the workers. Integrated view of multiple factors that influence employee work innovation as presented in this article makes a positive contribution for both theory and practice and it contributes significant value addition to the body of knowledge. This is also an implication for businesses to promote the effectiveness of creative and innovative activities in the organization.

#### References

- [1] Amabile, T.M., (1988). A model of creativity and innovation in organizations. *Research in Organizational Behavior*, 10, 123-167.
- [2] Amabile, T.M. (1996). Creativity and innovation in organization. Harvard Business School Background Note 396-239, January, 1-15.
- [3] Anderson, N.N.R., De Dreu, C.K.W. & Nijstad, B.A., (2004). The routinization of innovation research: A constructively critical review of the state-of-the-science. *Journal of Organizational Behavior*, 25, 147-173.
- [4] Baer, M., (2012). Putting creativity to work: The implementation of creative ideas in organizations. *Academy of Management Journal*, 55, 1102-1119.
- [5] Baker, T.L., Rapp, A., Meyer, T. & Mullins, R., (2014). The role of brand communications on front line service employee beliefs, behaviors, and performance. *Journal of Academy of Marketing Science*, 42, 642-657.
- [6] Basu, R. & Green, S.G., (1997). Leader-Member exchange and transformational leadership: An empirical examination of innovative behaviors in Leader-Member dyads. *Journal of Applied Social Psychology*, 27(6), 477-499.
- [7] Binnewies, C. & Gromer, M., (2012). Creativity and innovation at work: The role of work characteristics and personal initiative. *Psicothema*, 24(1), 100-105.
- [8] Bronn, P.S. & Vrioni, A.B., (2001). Corporate social responsibility and cause-related marketing: an overview. *International Journal of Advertising*, 20, 207-222.
- [9] Brown, T. J. & Dacin, P.A., (1997). The company and the product: Corporate associations and consumer product responses. *Journal of Marketing*, 61(Jan), 68-84.
- [10] Burmann, C., Zeplin, S. & Riley, N., (2009). Key determinants of internal brand management success: an exploratory empirical analysis. *Journal of Brand Management*, 16(4), 264-284.
- [11] Carmeli, A., Meitar, R. & Weisberg, J. (2006). Self-leadership skills and innovative behaviour at work. *International Journal of Manpower*, 27, 75-90.
- [12] Carmeli, A. & Spreitzer, G.M. (2009). Trust, connectivity, and thriving: Implications for innovative behaviors at work. *The Journal of Creative Behavior*, 43(3), 169-191.
- [13] Clarkson, M. (1995). A stockholder framework for analyzing and evaluating corporate social performance. *Academy of Management Review*, 20(1), 92-117.
- [14] De Clercq, D., Dimov, D. & Belausteguigoitia, I. (2016). Perceptions of adverse work conditions and innovative behavior: The buffering roles of relational resources. *Entrepreneurship Theory and Practice*, 40(3), 515-542.
- [15] De Dreu, C.W., & West, M.A. (2001). Minority dissent and team innovation: The importance of participation in decision making. *Journal of Applied Psychology*, 86(6), 1191-1201.
- [16] De Jong, J. & Den Hartog, D. (2007). How leaders influence employees' innovative behaviour. *European Journal of Innovation Management*, 10(1), 41-64.
- [17] De Jong, J. & Den Hartog, D. (2010). Measuring innovative work behavior. *Creativity and Innovation Management*, 19(1), 23-36.
- [18] Dorenbosch, L., van Engen, M.L. & Verhagen, M. (2005). On-the-job Innovation: The impact of job design and human resource management through production ownership. *Creativity and Innovation Management*, 14(2), 129-



- 141.
- [19] Dwyer, L., Edwards, D., Mistilis, N., Roman, C. & Scott, N. (2009). Destination and enterprise management for a tourism future. *Tourism Management*, 30(1), 63-74.
- [20] Trần Kim Dung (2009). *Quản trị nguồn nhân lực*. NXB Thống kê, TP.HCM
- [21] Feist, G.J. (1998). A meta-analysis of personality in scientific and artistic creativity. *Personality and social psychology review*, 2(4), 290-309.
- [22] Filho, J.M.S, Wanderley, L.S.O., Go1mez, C.P. & Farache, F. (2010). Strategic corporate social responsibility management for competitive advantage. *Brazilian Administration Review*, 7(3), 294-309.
- [23] Furnham, A. & Bachtiar, V. (2008). Personality and intelligence as predictors of creativity. *Personality and Individual Differences*, 45(7), 613-617.
- [24] Garg, P. & Rastogi, R. (2006). New model of job design: motivating employees' performance. *Journal of Management Development*, 25(6), 572-587.
- [25] George, J.M. & Zhou, J. (2001). When openness to experience and conscientiousness are related to creative behavior: An interactional approach. *Journal of Applied Psychology*, 86, 513-524.
- [26] George, J.M. & Zhou, J. (2007). Dual tuning in a supportive context: Joint contributions of positive mood, negative mood, and supervisory behaviors to employee creativity. *Academy of Management Journal*, 50, 605-622.
- [27] Giebels, E., de Reuver, R.S.M., Rispens, S. & Ufkes, E.G. (2016). The critical roles of task conflict and job autonomy in the relationship between proactive personalities and innovative employee behavior. *The Journal of Applied Behavioral Science*, 52(3), 320-341.
- [28] Holman, D., Totterdell, P., Axtell, C., Stride, C., Port, R., Svensson, R. & Zibarras, L. (2012). Job design and the employee innovation process: The mediating role of learning strategies. *Journal of Business and Psychology*, 27(2), 177-191.
- [29] Hsu, M.L., Hou, S.T. & Fan, H.L. (2011). Creative self-efficacy and innovative behavior in a service setting: Optimism as a moderator. *Journal of Creative Behavior*, 45(4), 258-272.
- [30] Hu, M.L.M. (2009). Knowledge sharing and innovative service behavior relationship: Guanxi as mediator. *Social Behavior and Personality*, 37(7), 977-992.
- [31] Hu, M.M., Horng, J. & Sun, Y.C. (2009). Hospitality teams: knowledge sharing and service innovation performance. *Tourism Management*, 30, 41-50.
- [32] Janssen, O. (2000). Job demands, perceptions of effort-reward fairness and innovative work behaviour. *Journal of Occupational and Organizational Psychology*, 73(3), 287-302.
- [33] Janssen, O. (2004). How fairness perceptions make innovative behavior more or less stressful. *Journal of Organizational Behavior*, 25(2), 201-215.
- [34] Kalyar, M. (2011). Creativity, self-leadership and individual innovation. *The Journal of Commerce*, 3(3), 20-28.
- [35] Keller, R.T. (2001). Cross-functional project groups in research and new product development: diversity, communications, job stress and outcomes. *Academy of Management Journal*, 4, 546-555.
- [36] Kim, H.R., Lee, M., Lee, H.T. & Kim, N.M. (2010). Corporate social responsibility and employee-Company Identification. *Journal of Business Ethics*, 95(4), 557-569.
- [37] Kim, Y.W. & Ko, J. (2014). HR practices and knowledge sharing behavior: Focusing on the moderating effect of trust in supervisor. *Public Personnel Management*, 43(4), 586-607.
- [38] King, C. (2010). One size doesn't fit all: Tourism and hospitality employees' response to internal brand management. *International Journal of Contemporary Hospitality Management*, 22(4), 517-534.
- [39] Kumar, R. & Uzkuurt, C. (2010). Investigating the effects of self-efficacy on innovativeness and the moderating impact of cultural dimensions. *Journal of International Business and Cultural Studies*, 4, 1-15.
- [40] Nguyễn Hữu Lam (2007). *Hành vi tổ chức*. NXB Thống kê, Hà Nội.
- [41] Luthans, F., Norman S.M., Avolio, B.J. & Avey, J.B. (2008). The mediating role of psychological capital in the supportive organizational climate: Employee performance relationship. *Journal of Organizational Behavior*, 29, 219-238.
- [42] Madrid, H.P., Patterson, M.G., Birdi, K.S., Leiva, P.I. & Kausel, E.E. (2014). The role of weekly high-activated positive mood, context, and personality in innovative work behavior: A multilevel and interactional model. *Journal of Organizational Behavior*, 35, 234-256.
- [43] Messman, G. & Mulder, R.H. (2011). Innovative work behaviour in vocational colleges: understanding how and why innovations are developed. *Vocations and Learning*, 4, 63-84.
- [44] Miron, E., Erez, M. & Naveh, E. (2004). Do personal characteristics and cultural values that promote innovation, quality, and efficiency compete or complement each other? *Journal of Organizational Behavior*, 25(2), 175-199.
- [45] Moenaert, R.K., Caeldries, F., Lievens, A. & Wauters, E. (2000). Communication flows in international product innovation teams. *Journal of Product Innovation Management*, 17(5), 360-377.
- [46] Nafei, W. (2015). Meta-analysis of the impact of psychological capital on quality of work life and organizational citizenship behavior: A study on Sadat City University. *International Journal of Business Administration*, 6(2), 42-59.
- [47] Noor, H.M & Dzulkifli, B. (2013). Assessing leadership practices, organizational climate and its effect towards

- innovative work behaviour in R&D. *International Journal of Social Science and Humanity*, 3(2), 129-133.
- [48] Ohly, S., Sonnentag, S. & Pluntke, F. (2006). Routinization, work characteristics and their relationships with creative and proactive behaviors. *Journal of Organizational Behavior*, 27, 257-279.
- [49] Ohly, S. & Fritz, C. (2010). Work characteristics, challenge appraisal, creativity, and proactive behavior: A multi-level study. *Journal of Organizational Behavior*, 31, 543-565.
- [50] Ottenbacher, M. (2007). Innovation management in the hospitality industry: Different strategies for achieving success. *Journal of Hospitality & Tourism Research*, 31(4), 431-454.
- [51] Park, Y.K., Song, J.H., Yoon, S.W. & Kim, J. (2014). Learning organization and innovative behavior: The mediating effect of work engagement. *European Journal of Training and Development*, 38(1/2), 75-94.
- [52] Parker, S.K., Williams, H.M. & Turner, N. (2006). Modeling the antecedents of proactive behavior at work. *Journal of Applied Psychology*, 91(3), 635-652.
- [53] Pavesic, D.V. & Brymer, R.A. (1990). Job satisfaction: what's happening to the young manager? *Cornell Hotel and Restaurant Administration Quarterly*, 30(4), 90-96.
- [54] Prahalad, C.K. & Ramaswamy, V. (2004). Co-creating unique value with customers. *Strategy and Leadership*, 32(3), 4-9.
- [55] Raja, U. & Johns, G. (2010). The joint effects of personality and job scope on in-role performance, citizenship behaviors and creativity. *Human Relations*, 63, 981-1005.
- [56] Rank, J., Nelson, N.E., Allen, T.D. & Xu, X. (2009). Leadership predictors of innovation and task performance: Subordinates' self-esteem and self-presentation as moderators. *Journal of Occupational & Organizational Psychology*, 82, 465-489.
- [57] Reuvers, M., van Engen, M.L., Vinkenbug, C.J. & Wilson-Evered, E. (2008). Transformational leadership and innovative work behaviour: Exploring the relevance of gender differences. *Creativity and Innovation Management*, 17(3), 227-244.
- [58] Salaman, G. & Storey, J. (2002). Managers' theories about the process of innovation. *Journal of Management Studies*, 39(2), 147-165.
- [59] Scott, S.G. & Bruce, R.A. (1994). Determinants of innovative behaviour: a path model of individual innovation in the workplace. *Academy of Management Journal*, 37(3), 580-607.
- [60] Shalley, C.E., Gilson, L.L. (2004). What leaders need to know: A review of social and contextual factors that can foster or hinder creativity. *The Leadership Quarterly*, 15(1), 33-53.
- [61] Shalley, C.E., Gilson, L.L. & Blum, T.C., (2000). Matching creativity efforts and the work environment: effects on satisfaction and intentions to leave. *Academy of Management Journal*, 43(2), 215-223.
- [62] Sheikhepoor, Z. & Sheikhepoor, M. (2015). Explaining the relationship between empowerment and work life quality: A case study on the staff of social security hospital of Zahedan city. *Journal of Health Management and Informatics*, 2(3), 101-107.
- [63] Shih, H.A. & Susanto, E. (2011). Is innovative behavior really good for the firm? Innovative work behavior, conflict with coworkers and turnover intention: moderating roles of perceived distributive fairness. *International Journal of Conflict Management*, 22(2), 111-130.
- [64] Shin, S.J., Kim, T.Y., Lee, J.Y. & Bian, L. (2012). Cognitive team diversity and individual team member creativity: A cross-level interaction. *Academy of Management Journal*, 55, 197-212.
- [65] Skerlavaj, M., Song, J. & Lee, Y. (2010). Organizational learning culture, innovative culture and innovations in South Korean firms. *Expert Systems with Applications*, 37(9), 6390-6403.
- [66] Smith, N.C. (2003). Corporate social responsibility: whether or how?. *California Management Review*, 45(4), 52-76.
- [67] Subramaniam, I.D. (2012). Determinant of innovative behavior in the workplace: A case study of a Malaysian public sector organisation. *American Journal of Social Issues & Humanities*, 2(6), 384-397.
- [68] Thamhain, H.J. (2003). Managing innovative R&D teams. *R & D Management*, 33(3), 297-311.
- [69] Thomson, K., deChernatony, L., Arganbright, L. & Khan, S. (1999). The buy-in benchmark: How staff understanding and commitment impact brand and business performance. *Journal of Marketing Management*, 15, 819-835.
- [70] Tseng, C.Y., Kuo, H.Y. & Chou, S.S. (2008). Configuration of innovation and performance in the service industry: evidence from the Taiwanese hotel industry. *The Service Industries Journal*, 28(7), 1015-1028.
- [71] Van der Veegt, G. & Janssen, O. (2003). Joint Impact of Interdependence and Group Diversity on Innovation. *Journal of Management*, 29(5), 729-751.
- [72] Van der Panne, G., Van der Beers, G. & Kleinknecht, A. (2003). Success and failure of innovation: A literature review. *International Journal of Innovation Management*, 7(3), 309-339.
- [73] Van de Ven, A.H. (1986). Central problems in the management of innovation. *Management Science*, 32, 590-607.
- [74] Vincent, A.S., Decker, B.P. & Mumford, M.D. (2002). Divergent thinking, intelligence and expertise, a test of alternative models. *Creativity Research Journal*, 14, 163-178.
- [75] Vinarski-Peretz, H. & Carmeli, A. (2011). Linking care felt to engagement in innovative behaviors in the workplace: The mediating role of psychological conditions. *Psychology of Aesthetics, Creativity, and the Arts*, 5,

43-53.

- [76] West, M.A. & Hirst, G. (2003). Cooperation and teamwork for innovation. In M.A. West., D. Tjosvold, and K.G. Smith (eds.): *International Handbook of Organizational Teamwork and Cooperative Working*. Chichester: John Wiley Sons, Ltd., 297-319.
- [77] Zhou, J. (2003). When the presence of creative coworkers is related to creativity: Role of supervisor close monitoring, developmental feedback, and creative personality. *Journal of Applied Psychology* , 88(3), 413-422.
- [78] Zhou, Z., Ma, Y., Cheng, W. & Xia, B. (2014). Mediating role of employee emotions in the relationship between authentic leadership and employee innovation. *Social Behavior and Personality*, 42(8), 1267-1278.
- [79] Yesil, S. & Sozbilir, F. (2013). An empirical investigation into the impact of personality on individual innovation behaviour in the workplace. *Procedia-Social and Behavioral Sciences*, 81, 540-551.
- [80] Yu, C., Yu, T.F., & Yu, Chin-Cheh (2013). Knowledge sharing, organizational climate, and innovative behavior: A cross-level analysis of effects. *Social Behavior and Personality: An International Journal*, 41(1), 143-156.
- [81] Yu, Y. & Choi, Y. (2014). Corporate social responsibility and firm performance through the mediating effect of organizational trust in Chinese firms. *Chinese Management Studies*, 8(4), 577-592.
- [82] Yuan, F. & Woodman, R.W. (2010). Innovative behavior in the workplace: The role of performance and image outcome expectations. *Academy of Management Journal*, 53(2), 323-342.

# Adapting Digital Technology to Accelerate Financial Inclusion: The Case of Vietnam Banking Sector

Tran Nguyen Minh Hai <sup>a\*</sup>

<sup>a</sup>Banking University of HCMC, 36 Ton That Dam Street, District 1, HCMC, Viet Nam.

## ABSTRACT

Since financial inclusion is universal access, at a reasonable cost, to a wide range of financial services, provided by a variety of sound and sustainable institutions (UN, 2017), the paper focused on an overview of adapting digital technology in Viet Nam banking sector to accelerate financial inclusion in the context of industrial revolution 4.0. This adaptation of digital technology in banking sector requires expanding internet banking and mobile banking, banking services, providing information and increasing understanding of banking services, completing the legal regulation framework, and completing the financial and telecom infrastructure (VNS, 2017). By qualitative analysing the respective secondary data collected from reliable sources such as World Bank (WB), International Monetary Fund (IMF), State Bank of Viet Nam (SBV), the paper emphasized the necessary role of using modern technology as favourable condition to Viet Nam banking sector with the “fit-to-purpose” approach in speeding up financial inclusion, enhancing the quality of financial services as well as expanding their financial services to remote and rural areas, SMEs, saving expenditure and developing sustainably.

**Keywords:** Banking; Digital technology; Financial inclusion; Fit-to-purpose; Viet Nam

## 1. Introduction

Since finance is the system of economic relations that arises in the process of creating and using respective monetary funds to meet the consumption and accumulation needs of the subjects in society, especially individuals and businesses, financial inclusion is becoming a priority for policymakers, regulators and development agencies globally (WB, 2015; UN, 2015). Countries, which have achieved the most progress toward financial inclusion, have put in place an enabling regulatory and policy environment, and have encouraged competition allowing banks and non-banks to innovate and expand access to financial services. The opportunities of industrial revolution 4.0, especially the development of digital financial technology and the global spread of using smart phone, has facilitated expanding access to financial and banking services to hard-to-reach populations and small businesses at low cost and risk. Digital technology has already emerged as a game-changing enabler across many industries, and is now beginning to create a similar impact in financial services. According to the estimated report of Wyman, O. (2016), digital technology could result in \$1 trillion of increased revenue and cost savings, equivalent to about 17% of global financial services industry revenue in 2016.

The paper focuses on the application of digital technology to promote financial inclusion Viet Nam banking sector. Specifically, the paper reviews (i) the current situation of financial inclusion in Viet Nam and the penetration of digital technology adaption in Viet Nam banking sector; (ii) the opportunities and challenges of applying digital technology in Viet Nam banking sector by PEST model.

The rest of the paper is structured as followings: (i) section 2 presents the theoretical background; (ii) section 3 describes the methodology; (iii) section 4 presents the findings and results; and (iv) conclusions place in section 5.

\* Tel.: 0902 927 929

E-mail address: minhhai2407@gmail.com

## 2. Theoretical framework

### 2.1. The concept of financial inclusion

The concept of financial inclusion can be decomposed into two dimensions as following:

Firstly, financial inclusion refers to a customer having access to a range of formal financial services, from simple credit and savings services to the more complex such as insurance and pensions;

Secondly, financial inclusion implies that customers have access to more than one financial services provider, which ensures a variety of competitive options.

According to CFI (2008), financial inclusion is as a state in which everyone who can use them has access to a range of quality financial services at affordable prices delivered by a range of providers in a competitive market with convenience, dignity and consumer protections, to financially capable clients.

Meanwhile, GPFI (2012) emphasizes the suitable age to access financial inclusion in their definition. Hence, financial inclusion refers to a state in which all working age adults have effective access to credit, savings, payments, and insurance from formal service providers. “Effective access” involves convenient and responsible service delivery, at a cost affordable to the customer and sustainable for the provider, with the result that financially excluded customers use formal financial services rather than existing informal options.

And WB (2017a) defines generally that financial inclusion relates to the needs of individuals and businesses. Hence, financial inclusion means that individuals and businesses have access to useful and affordable financial products and services that meet their needs – transactions, payments, savings, credit and insurance - delivered in a responsible and sustainable way.

The UNCDF (2016) also agrees that financial inclusion means that individuals and enterprises can access and use a range of appropriate and responsibly provided financial services offered in a well-regulated environment. There is a growing evidence that increased levels of financial inclusion - through the extension of savings, credit, insurance, and payment services - contributes significantly to sustainable economic growth.

In generally, financial inclusion is universal access, at a reasonable cost, to a wide range of financial services, provided by a variety of sound and sustainable institutions. Inclusive finance strives to enhance access to financial services for both individuals and micro-, small and medium-sized enterprises. In developing countries, access to financial services is crucial to strengthen financial sectors and domestic resource mobilization and can therefore make a significant contribution to social and economic development (UN, 2017).

### 2.2. The role of financial inclusion toward sustainable development

Since finance is the system of economic relations that arises in the process of creating and using monetary funds to meet the consumption and accumulation needs of the subjects in society, there is global attention paid to financial inclusion and policies as well as devoted to enhancing access to finance.

Having a transaction account is the first step toward broader financial inclusion because it allows people to store money, and send and receive payments. Moreover, a transaction account can also serve as a gateway to other financial services which is why ensuring that people worldwide can have access to a transaction account is the focus of the World Bank Group’s Universal Financial Access 2020 initiative. Accordingly, financial access facilitates day-to-day living, and helps families and businesses plan for everything from long-term goals to unexpected emergencies. As accountholders, people are more likely to use other financial services, such as credit and insurance, start and expand businesses, invest in education or health, manage risk, and weather financial shocks, all of which can improve the overall quality of their lives (WB, 2015; ACfA, 2017; Hoa, N. T., 2017).

The United Nations General Assembly adopted the 2030 Agenda for Sustainable Development, along with a new set of 17 development goals that are collectively called the Sustainable Development Goals (SDGs). Although the SDGs do not explicitly target financial inclusion, the greater access to financial services is a key enabler for many of countries toward sustainable development (UN, 2015; Klapper, L., El-Zoghbi, M., & Hess, J., 2016).

### 2.3. Financial inclusion in the digital age

Digital financial technology, or “fintech” and particularly the global spread of mobile phones, has facilitated expanding access to financial services to hard-to-reach populations and small businesses at low cost and risk in the financial inclusion market from the formal financial system (RBI, 2008; ACfA, 2017; Luc, C. V., 2017):

Digital IDs make it easier than ever before to open an account

Digitization of cash-payments is introducing more people to transaction accounts

Mobile-based financial services bring convenient access even to remote areas

Greater availability of customer data allows providers to design digital financial products that better fit the needs of unbanked individuals...

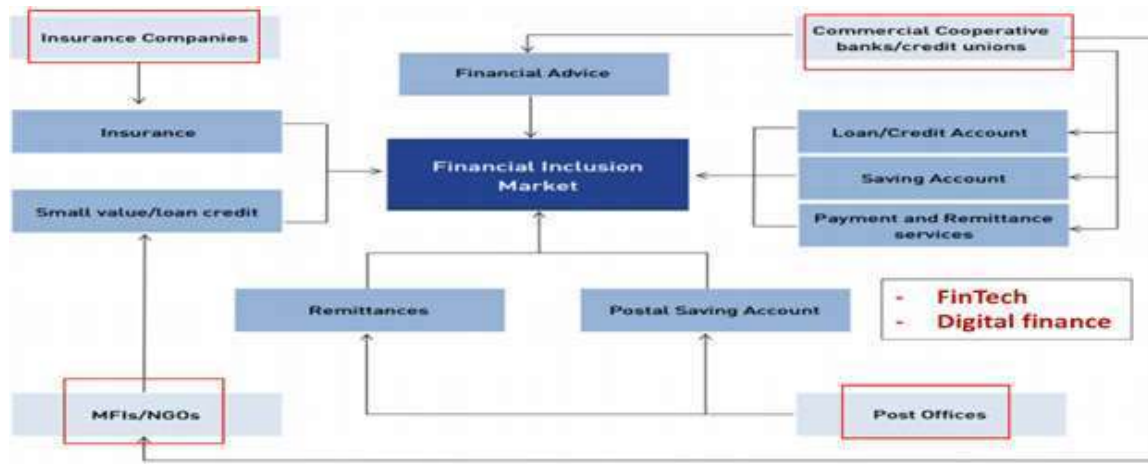

**Figure. 1. The institutional structure and financial products in financial inclusion market.**

Source: RBI (2008).

Therefore, businesses and governments have many opportunities to expand financial inclusion in emerging countries by digitizing cash payments of wages and transfers as a first important step (Klapper, L., El-Zoghbi, M., & Hess, J., 2016). It also implies that through the linking between financial inclusion and development, the financial services can help achieve the SDGs, especially in the current context of industrial revolution 4.0.

According to McKinsey (2016), two billion individuals and 200 million businesses in emerging economies today lack access to savings and credit, and even those with access can pay dearly for a limited range of products. Rapidly spreading digital technologies now offer an opportunity to provide financial services at much lower cost, and therefore profitably, boosting financial inclusion and enabling large productivity gains across the economy.

Recent research of ADB (2017) finds that digital financial solutions could play a significant part in closing gaps in financial inclusion. They could address about 40% of the volume of unmet demand for payments services and 20% of the unmet credit needs in the base of pyramid and micro, small, and medium enterprises segments. Digital finance alone cannot entirely close the gaps in financial inclusion but the cumulative effect of digitally driven acceleration in financial inclusion could boost GDP by 2% to 3% in markets like Indonesia and the Philippines, and 6% in Cambodia. For the population earning less than \$2 a day, that would translate to a 10% increase in income in Indonesia and the Philippines, and an increase of around 30% in Cambodia.

**Table 1. Some positive impacts of digital solution on financial inclusion.**

Key area	Impact	Combination
Customer identification and verification	Offering a fast, low-cost and convenient processes	National identification numbers, a real time verification infrastructure And supporting regulatory frameworks
Last-mile distribution and servicing issues	Meaningfully altering the economics of the supply side by addressing through low-cost, widespread, digitally-enabled points of physical access	Mobile phones and point-of-sale (POS) devices
The payments value chain and ecosystem	Supporting throughout prevalent electronic payments	The person-to-all payments systems, interoperable networks and open application programming interface platforms
Accessibility to credit	Significantly enhancing by using alternative sources of data, improving customer profiling, credit risk assessment and fraud detection	Payment transactions and telecoms data, as well as analytics
The mobilization of savings	Serving digitally through alternative, lower-cost origination and distribution channels and more-convenient product designs such as mobile wallets connected to savings accounts and intuitive goal-based savings	Regulatory frameworks and onboarding process

Source: ADB (2017).

With positive effects above, digital technology has not only increased the access to financial services from the formal financial system through electronic transaction channels, reduced costs, reduced the risk of loss, stealing as in the case of cash transaction but also added financial services tailored to the needs of customers on the digital platform by transitioning the procurement approach from “one size fits all” to “fit for purpose”.

However, although this innovation (including in payment services and market infrastructure; leveraging transaction data and other sources of data for credit appraisals; deposits, lending and capital raising; investment management) can provide a significant boost to financial inclusion, digital finance also presents new challenges in finance and banking regulations with awareness of protecting consumers in a rapidly changing and increasingly complex supply-side ecosystem, as well as dealing with the growing risks related to data governance ... (WB, 2016; ADB, 2017).

### **3. Methodology**

The concept of financial inclusion is still the new issue in Viet Nam. Hence, there is a lack of Viet Nam research on adapting digital technology to accelerate financial inclusion in banking sector in Viet Nam. Due to the limitation of time horizon, the qualitative approach is used in this paper with case of Viet Nam banking sector. By qualitative analyzing the respective secondary data collected from reliable sources such as World Development Indicators (WDI), World Bank (WB), International Monetary Fund (IMF), Financial Access Survey (FAS), International Financial Statistics (IFS), State Bank of Viet Nam (SBV), the paper is carried out in a top-down framework. The paper starts with the theoretical background, including the role of financial inclusion to sustainable development and financial inclusion in the digital age. Then, the paper focuses on the current situation of Viet Nam financial inclusion through the depth and accessibility of financial institutions as well as the opportunities and challenges from the application of digital technology in banking sector of Viet Nam by PEST model. Those findings will be the basis for conclusions to promoting financial inclusion by adapting digital technology in Viet Nam banking sector.

### **4. Findings**

#### **4.1. The current situation of financial inclusion from the formal financial system in Viet Nam**

According to the State Bank of Viet Nam, financial inclusion is understood as providing appropriate and convenient financial service to all individuals and organizations, specially low-income and vulnerable individuals, thereby increasing more opportunities to get access to financial services, contributing to creating livelihood opportunities, rotating the flows of investment capital to boost economic growth (SBV, 2016; SBV, 2017).

With this understanding, the measurement of financial inclusion in Viet Nam banking sector is not paid much attention to the efficiency and the stability aspects of financial institutions, but their depth and accessibility aspects. Consequently, there are two aspects of measurement to address the financial inclusion from the formal financial system in banking sector classified by the State Bank of Viet Nam as following:

The depth of financial institutions to private credits and deposits in the economy: This aspect describes the financial depth which captures the financial sector relative to the economy. It is the size of banks, other financial institutions, and financial markets in a country, taken together and compared to a measure of economic output. And the proxy variable that has received much attention in the empirical literature in this regard is private credit relative to GDP. More specifically, the variable is defined as domestic private credit to the real sector by deposit money banks as percentage of local currency GDP. The private credit, therefore, excludes credit issued to governments, government agencies, and public enterprises. It also excludes credit issued by central banks (WB, 2017b).

The accessibility of financial institutions to providing formal financial services: This includes the geographic penetration and demographic penetration, such as the number of branches of commercial banks, the number of ATMs per 100,000 adults, the bank accounts per 1,000 adults ...

##### **4.1.1. By the depth of financial institutions**

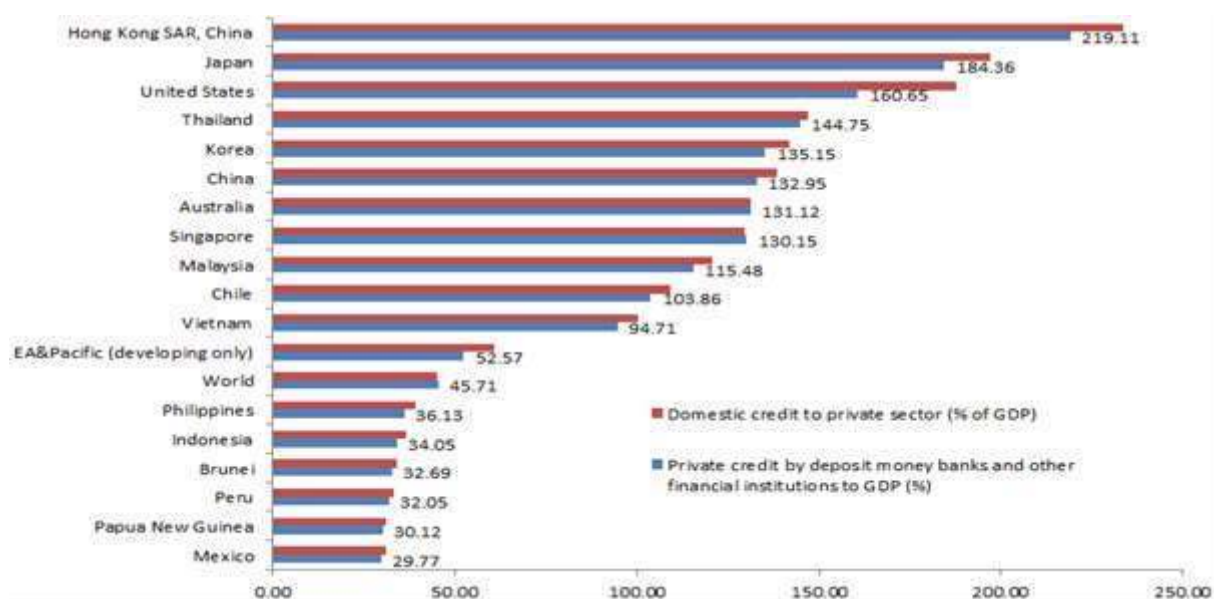

Figure 2. The depth of financial institution across economies in 2014 (%).

Source: WB (2014).

The monetary policy of Viet Nam pursues a multi-pronged policy of productivity, unemployment and inflation in the economy. Thus, the banking system of Vietnam plays an important role in developing the economy by coordinating the target credit growth.

The figure 1 points out that it is easy to see the far-reaching impact of lending from financial institutions, mainly from the banking sector, to the individuals and organizations in the economy relative to the average of the world, but still relatively low with comparison to other economies in the Asia-Pacific region.

However, although private credit by deposit money banks and other financial institutions has a high percentage to GDP, but when compared with the absolute figure for Viet Nam's GDP at about 200 billion USD, the volume is still very thin.

#### 4.1.2. By the accessibility of financial institutions

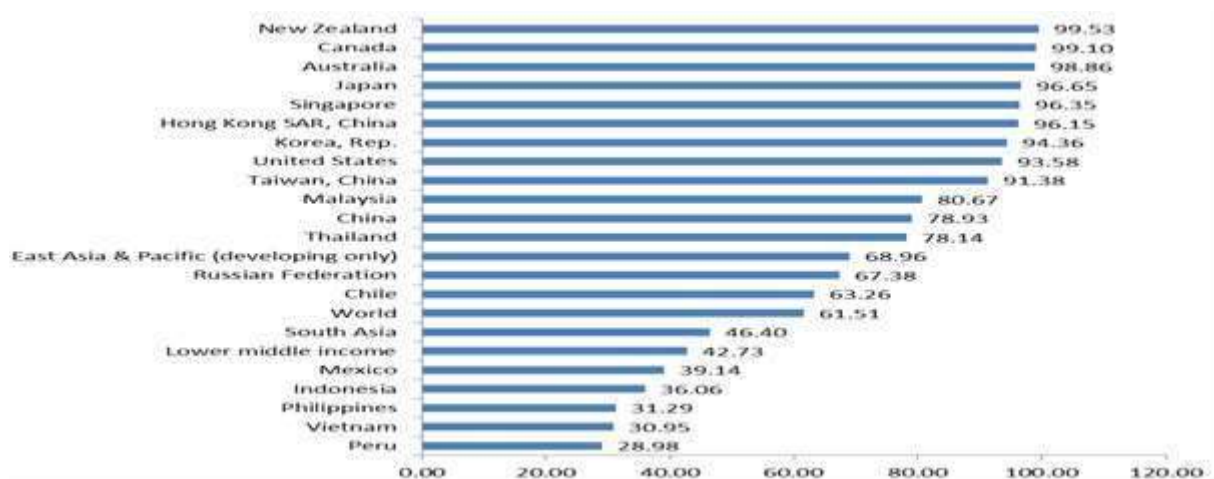

Figure 3. The rate of adults having account at a bank across economies in 2014 (%).

Source: WB (2014).

Regarding the individual accessibility to financial services and products, the WB data (2014) investigates that the rate of using basic financial products and services through the system of financial institutions such as money withdrawal, money transfer, savings, credits ... of the individuals in Viet Nam are gradually narrowing the gap to the average of low middle-income economies as well as developing economies in the Asia-Pacific region. However, the figure 2 shows that in 2014, the proportion of all adults with account (s) in Viet Nam financial institution is 30.95%. It



is still far below the global average rate, and even lower than the average 42.73% that low middle-income countries has achieved.

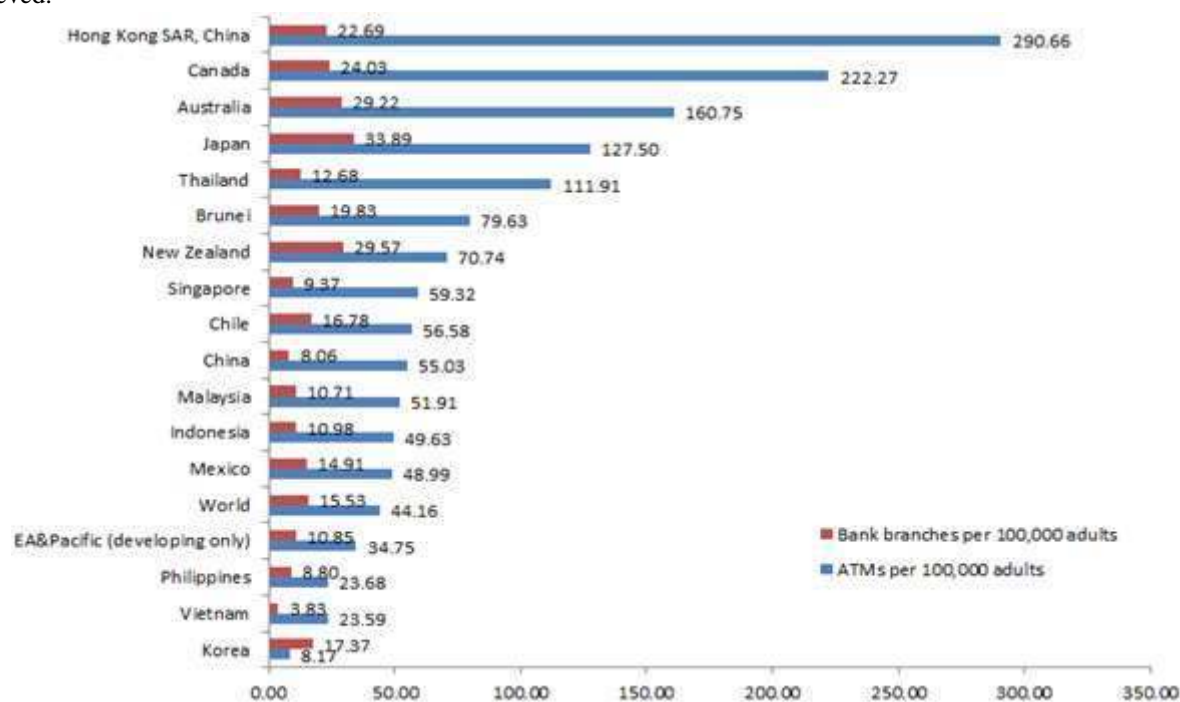

**Figure 4. The access to financial institutions across economies in 2014.**

Source: Financial Access Survey (FAS), International Monetary Fund (IMF) data.

Besides, the figure 3 shows that the number of ATMs and bank branches per 100,000 adults in Viet Nam is still low and concentrated in urban areas, especially in big cities such as Ho Chi Minh City, Ha Noi ... in comparison with the other economics.

Other measurements of financial access in the banking sector also share the same modest results. With a population of over 90 million, these evidences imply that access to formal financial services in Vietnam is still difficult due to geographic and demographic aspects of penetration.

In table 2, it is addressed that 10.8% of Viet Nam SMEs in 2016 still identify the access to finance as a major constraint and the access to formal financial services, especially business loans in terms of collateral assets from banks.

**Table 2. The access to finance for SMEs.**

Indicator	Viet Nam	East Asia & Pacific	All Countries
% of firms with a checking or savings account	55.8	77.0	86.8
% of firms with a bank loan/line of credit	40.8	28.3	33.8
% of loans requiring collateral	91.0	82.6	79.3
Value of collateral needed (% of the loan amount)	216.0	238.4	206.8
% of firms not needing a loan	50.0	50.7	46.5
% of firms whose recent loan application was rejected	5.6	6.4	11.9
% of firms using banks to finance investments	29.3	20.5	25.4
% of investments financed internally	67.3	77.8	71.2

% of investments financed by banks	15.4	10.4	14.4
% of firms using banks to finance working capital	32.3	25.4	30.3
% of firms using supplier/customer credit to finance working capital	21.2	21.0	31.0
% of working capital financed by banks	13.1	10.4	11.7
% of firms identifying access to finance as a major constraint	10.8	11.3	26.3

Source: WB Enterprise Surveys (2016).

## 4.2. The adaption of digital technology in accelerating financial inclusion in Viet Nam banking sector

### 4.2.1. The penetration of digital innovation in financial services of Viet Nam banking sector

As customers' experience, their expectations of using financial services are (i) the simplification with minimal operations required; (ii) personalization with guaranteed privacy and (iii) daily and seamless solutions. These features are well suited to explain the reason for popular mobile device usage in the economy as the compact and convenient devices for harnessing big data. On the other hand, a mobile device that is at high speed, always connected, aesthetically satisfaction, easy to utilize, light, free of annoying features with a wide array of optional applications.

In recent 10 years, the investment in technology application in the Viet Nam banking industry has been extensively. By approaching the concept of "fit to purpose" with peer-to-peer platform when using smart phones to access internet individually, most of the banks have provided internet banking, mobile banking, other non-cash payments (card transaction, ATMs & POS transaction, e-wallet, for example) for customers and computerized internal banking process.

Although the proportion of penetration is still low and concentrated in urban areas, especially big cities, it is expected that these applications and services of e-banking become accessible to individuals and organizations as well as the development of Fintech services provides multiple payment service channels, thereby, supporting to access to financial inclusion rapidly in Viet Nam banking sector.

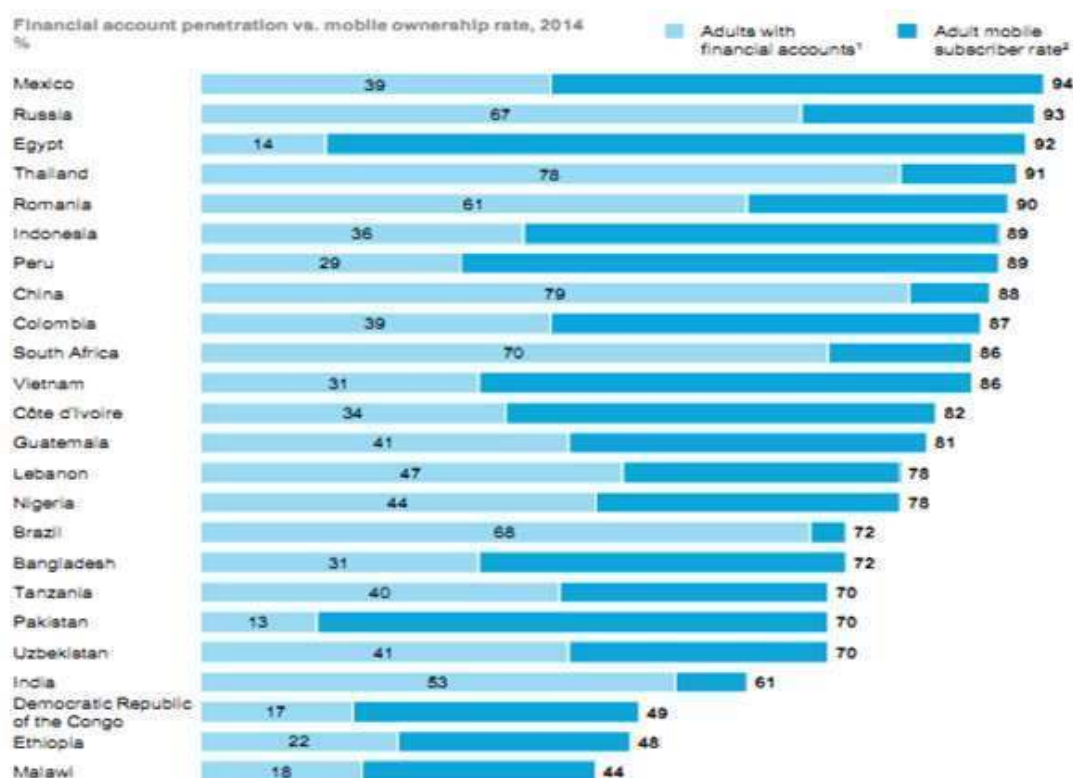

Figure 5. The digital financial penetration by country in 2014.

Source: McKinsey (2016).

The figure 3 shows the significant potential of providing financial services via mobile phone across economies in 2014 (McKinsey, 2016). With nearly 31% of the population aged 15 and above having bank accounts, but 86% of the total population having mobile phone subscriptions, hence, Viet Nam can fully use digital technology with great expectation to diversify financial services as well as promote financial inclusion in formal banking sector as figure 4 shown.



**Figure. 6. The diversification of digital financial services in banking sector.**

Source: Hanh, D. H. (2017).

#### 4.2.2. Opportunities and Challenges

By analyzing four macro-factors of PEST model, the opportunities and challenges of the adaption digital technology in accelerating financial inclusion in Viet Nam banking sector are as following:

**Table 3. The opportunities and challenges of adaption digital financial services.**

Key area	Opportunities	Challenges
P- Political	SBV has built several regulations to adapt digital technology to accelerate financial inclusion in banking sector related to non-cash payments, micro-finance, digital financial services, Fintech, information security ...	The incompleteness of legal regulatory framework in creating the enabling conditions for financial service providers while ensuring that risks are mitigated and consumers are properly protected
E – Economic	The cooperation of Financial service providers, telecom operators, Fintech has quickly grasped and focused on digital technology The expansion of distribution channel towards diversity, especially focus on new, high efficiency ones, such as internet banking, mobile banking	The increasing technological risks, investment cost, R & D cost, changing business model & processes The incompleteness of financial and telecommunication infrastructure
S – Social	Huge domestic market with young customers, easily access to new consumer trends The rate of internet & mobile user is among the highest globally	The lack of financial knowledge and awareness regarding complicated products and procedures to be able to understand and use the services provided The lack of financial product and service diversification that meets the needs of consumers
T - Technological	Industrial Revolution 4.0 and digital finance trends increased availability of modern financial products/services for customers as well as reduced cost, increased productivity	The imbalance between innovation and risk management, especially the information security and cyber security for finance sector

Source: Author's analysis.

The table 3 shows that the adaption of digital technology to accelerate financial institution in banking sector also encountered many obstacles from the macro factors. Because of the competitive market, banks must continually improve to provide the right products to lead or meet market demand. But in the digital financial trends, banks also raise their awareness of cyber security and promote the experience of customers.

Besides, The State Bank of Viet Nam also plays an important role in market surveillance through regulatory frameworks for parties involved in the application of digital technology, especially the protection of customers' rights.

The opportunities brought by Industrial Revolution and digital financial trends are not the miracle to make everything better instantly and easily. In the last 10 years, banking sector has been the first field applying technology in operation and organization compared to other industries in Viet Nam but the active volume of customers using digital financial services is still thin with low coverage. However, digital technology is the favourable condition to advancing the long term sustainable development of banking sector ahead, especially in accelerating financial inclusion with the "fit to purpose" approach.

## 5. Conclusions

In generally, in order to ensure that individuals and organizations in economy are able to access affordable financial services, the Viet Nam banking sector needs to focus more on depth level of penetration in enhancing service quality which will attract and promote more individuals and business organizations to access and use financial services to meet their needs. Besides, Viet Nam banking sector also needs to pay more attention to the groups of people such as the poor, rural and remote areas, especially SMEs to accelerate their accessibility to financial inclusion.

This also implies that Viet Nam banking sector is moving toward the approach of "fit-to-purpose" and the adaption of digital technology becomes the favourable condition to accelerate financial inclusion.

As the global digital economy grows rapidly and the economic development is usually a long journey, the adaption of digital technology in banking sector play an important role in speeding up the progress and at a relatively affordable cost by supplying a more convenient, low-cost way for individuals and businesses to take advantage of new opportunities. Furthermore, the digital infrastructure and legal regulations are being further upgraded to overcome its challenges as well as their benefits are within reach and available now from its opportunities. The sooner the adaption of digital technology is, the faster the rewards will come with the higher growth, greater innovation, and more inclusion.

### Acknowledgements

I am grateful to the State Bank of Viet Nam (SBV) and the Banking University of HCMC (BUH) for offering the opportunity of understanding the financial inclusion in the digital age at the Viet Nam Banking Conference 2017 in HCMC; my colleagues for valuable insights and helpful comments; my beloved mother for supporting me unconditionally; my students and my own business in fresh organic food sector named alofoods.vn for being my important motivations. All errors are my responsibility.

## References

- [1] ACfA (2017). Financial Inclusion. Online available at: <http://africancrowd.org/social-impact/financial-inclusion/> (Accessed 8th July, 2017).
- [2] ADB (2017). [Accelerating Financial Inclusion in South-East Asia with Digital Finance](https://www.adb.org/sites/default/files/publication/222061/financial-inclusion-se-asia.pdf). Online available at: <https://www.adb.org/sites/default/files/publication/222061/financial-inclusion-se-asia.pdf> (Accessed 8th July, 2017).
- [3] CFI (2008). Who we are – Our vision. Online available at: <http://www.centerforfinancialinclusion.org/about> (Accessed 25th Jun 2017).
- [4] GPFI (2012). Global Standard-Setting Bodies and Financial Inclusion for the Poor - Toward Proportionate Standards and Guidance (Accessed 25th June, 2017).
- [5] Hanh, D. H. (2017). Data analysis in Viet Nam banking sector. Banking Viet Nam Conference 2017 (Accessed 6th August, 2017).
- [6] Hoa, N. T (2017). The overview of financial inclusion and the role of digital technology in accelerating financial inclusion in Viet Nam. Banking Viet Nam Conference 2017 (Accessed 25th June, 2017).
- [7] Klapper, L., El-Zoghbi, M., & Hess, J. (2016). Achieving the Sustainable Development Goals, The Role of Financial Inclusion. United Nations Secretary General's Special Advocate for Inclusive Finance for Development.
- [8] Luc, C. V (2017). Opportunities, challenges and strategic solutions to accelerate financial inclusion in Vietnam in the digital age. Banking Viet Nam Conference 2017 (Accessed 25th June, 2017).
- [9] McKinsey (2016). [Digital finance for all: Powering inclusive growth in emerging.](#)
- [10] RBI (2008). Financial Inclusion. Publication of Reserve Bank of India. Online available at: <https://rbi.org.in/Scripts/PublicationsView.aspx?id=10494> (Accessed 23th July, 2017).
- [11] SBV (2016). Financial Inclusion in Viet Nam – Opportunities and Challenges. Online available at: [https://www.sbv.gov.vn/webcenter/portal/vi/menu/trangchu/ttsk/ttsk\\_chitiet?leftWidth=20%25&showFooter=false&showHeader=false&dDocName=SBV246671&rightWidth=0%25&centerWidth=80%25&\\_afrLoop=28183009](https://www.sbv.gov.vn/webcenter/portal/vi/menu/trangchu/ttsk/ttsk_chitiet?leftWidth=20%25&showFooter=false&showHeader=false&dDocName=SBV246671&rightWidth=0%25&centerWidth=80%25&_afrLoop=28183009)

8733000#%40%3F\_afrLoop%3D281830098733000%26centerWidth%3D80%2525%26dDocName%3DSBV246671%26leftWidth%3D20%2525%26rightWidth%3D0%2525%26showFooter%3Dfalse%26showHeader%3Dfalse%26\_adf.ctrl-state%3D2hncok8th\_9 (Accessed 5th August, 2017).

- [12] SBV (2017). Opening of Banking Vietnam 2017. Online available at: [https://www.sbv.gov.vn/webcenter/portal/en/home/sbv/news/news\\_chitiet?leftWidth=20%25&showFooter=false&showHeader=false&dDocName=SBV288551&rightWidth=0%25&centerWidth=80%25&\\_afrLoop=282682761463000#%40%3F\\_afrLoop%3D282682761463000%26centerWidth%3D80%2525%26dDocName%3DSBV288551%26leftWidth%3D20%2525%26rightWidth%3D0%2525%26showFooter%3Dfalse%26showHeader%3Dfalse%26\\_adf.ctrl-state%3D2hncok8th\\_51](https://www.sbv.gov.vn/webcenter/portal/en/home/sbv/news/news_chitiet?leftWidth=20%25&showFooter=false&showHeader=false&dDocName=SBV288551&rightWidth=0%25&centerWidth=80%25&_afrLoop=282682761463000#%40%3F_afrLoop%3D282682761463000%26centerWidth%3D80%2525%26dDocName%3DSBV288551%26leftWidth%3D20%2525%26rightWidth%3D0%2525%26showFooter%3Dfalse%26showHeader%3Dfalse%26_adf.ctrl-state%3D2hncok8th_51) (Accessed 5th August, 2017).
- [13] UN (2015). Sustainable Development Goals. Online available at: <http://www.un.org/sustainabledevelopment/sustainable-development-goals/> (Accessed 8th July, 2017).
- [14] UN (2017). Inclusive & Local Finance. Online available at: <http://www.un.org/esa/ffd/topics/inclusive-finance.html> (Accessed 25 Jun, 2017).
- [15] UNCDF (2016). Financial inclusion. Online available at: <http://www.uncdf.org/financial-inclusion> (Accessed 25th Jun, 2017).
- [16] VNS (2017). [Financial inclusion in VN revolves around technology: conference](http://bizhub.vn/banking/financial-inclusion-in-vn-revolves-around-technology-conference_286263.html). Online available at: [http://bizhub.vn/banking/financial-inclusion-in-vn-revolves-around-technology-conference\\_286263.html](http://bizhub.vn/banking/financial-inclusion-in-vn-revolves-around-technology-conference_286263.html) (Accessed 25th June, 2017).
- [17] WB (2014). Viet Nam. Financial inclusion data/Global Findex. Online available at: <http://datatopics.worldbank.org/financialinclusion/country/vietnam> (Accessed 24th July, 2017).
- [18] WB (2015). Financial inclusion overview. Online available at: <http://www.worldbank.org/en/topic/financialinclusion/brief/achieving-universal-financial-access-by-2020> (Accessed 8th July, 2017).
- [19] WB (2016). FinTech and Financial Inclusion. World Bank Group.
- [20] WB (2017a). Universal Financial Access by 2020. Online available at: <http://www.worldbank.org/en/topic/financialinclusion/overview> (Accessed 25th June, 2017).
- [21] WB (2017b). Financial Depth. Online available at: <http://www.worldbank.org/en/publication/gfdr/background/financial-depth> (Accessed 5th August, 2017).
- [22] WB Enterprise Surveys (2016). Viet Nam. Online available at: <http://www.enterprisesurveys.org/data/exploreeconomies/2015/vietnam#finance> (Accessed 24th July, 2017).
- [23] Wyman, O. (2016). Modular Financial Services – the new shape of the industry.

# Measuring Misalignment between Vietnam and The United States Through Purchasing Power Parity

Tran Quoc Khanh Cuong\* , Pham Hoang An, Nguyen Dang Hat

Van Hien University, 665 – 667 – 669 Dien Bien Phu Street, Ho Chi Minh City, Vietnam

## ABSTRACT

The objective of this research is to measure the misalignment between Vietnam and The United State using Dynamic Ordinary Least Square through Purchasing Power Parity (PPP) approach. Unit root test, Johansen Co-integration test, Vector Error Correction Model are employed to investigate the relationship of PPP between Vietnam and The United States (U.S) with monthly time series data spans from 2010:1 to 2015:12. The results support the theory of PPP hold between Vietnam and U.S. The results indicates that evaluation of VND is fluctuated and overvalued at present.

**Keywords:** PPP; real exchange rate; VECM; Johansen Cointegration test; misalignment.

## 1. Introduction

Purchasing Power Parity (PPP) has crucial efficiency on the economy. Firstly, using PPP, the economists are able to forecast the exchange rate in the long-term and short-term because exchange rate tends to move in the same direction of PPP. The valuation of real exchange rate is very important for Vietnam. Kaminsky et al., (1998) and Chinn (2000) states that the appreciation of the exchange rate can lead to the crisis of emerging economies. It also affects not only on international commodity market but also international finance through exchange rate; therefore, the policy makers have their plans to react when exchange rate volatility happen and managers of enterprises should have suitable strategy to deal with that situation. Furthermore, exchange rate is very important to trade balance or balance of payment of a country. Finally, PPP helps the countries in comparing the position and economic performance through adjusting Gross Domestic Product. As a result, PPP has probably become one of the most argumentative topics in the world. In short, PPP is a good indicator for policy makers, multinational enterprises and exchange rate market participants.

The presence of PPP is mixed. Tasta (2005) finds that the PPP does not exist between Turkey and US or between Turkey and England in the long-run. Nevertheless, Baharumshah et al., (2010) found out the relationship between six Asian countries against the United States.

The results of PPP depend on countries and currencies used to check. In this paper, the authors aim to find out the existence of PPP between Vietnam and the United States.

This paper includes five sections: Section 1 presents the introduction, section 2 reviews the literature for PPP approach; section 3 illustrates the model specification; section 4 describes the methodology and data; and section 5 provides results and discussion.

## 2. Literature Review

Salamanca School in Spain was the first school to introduce the PPP in the 16th century. At that time, the meaning of PPP is basically about the price level of every country that should be the same when the common currency was changed (Rogoff, 1996).

The purchasing power parity (PPP) was then introduced by Cassel in 1918. After that, PPP became the benchmark for a central bank in building up the exchange rates and the resources for studying about exchange rate determinants. Balassa and Samuelson then were inspired by Cassel's PPP model when setting up their models in 1964. They worked independently and gave the final explanation of the establishment of the exchange rate theory based on the absolute PPP

\* Corresponding author. Tel.: +84 976638811.  
E-mail address: cuong.tqk@vnp.edu.vn

(Asea & Corden, 1994). It can be explained that when we change any amount of money into the same currency, the relative price of each good in different countries should be the same.

There are two versions of the PPP, which are the absolute and relative PPP (Balassa, 1964). According to the first version, Krugman et al., (2012), defines the absolute PPP as the the exchange rate of pair countries equal to the ratio of the price level of those countries, meaning as follows:

$$s_t = \frac{P_t}{P_t^*} \quad (1)$$

On the other hand, Shapiro (1983) stated that the relative PPP can be defined as the ratio of domestic to foreign prices equal to the ratio change in the equilibrium exchange rate. There is a constant  $k$  modifying the relationship between the equilibrium exchange rate and price levels, as presented below:

$$s_t = k^* \frac{P_t}{P_t^*}$$

In the empirical studies, checking the validity of PPP by unit root test was popular in 1980s based on Dickey and Fuller approach, nevertheless, this approach has the low power (Ender & Granger, 1998).

After that, Johansen (1988) developed a method of conducting VECM, which has become the benchmark model for many authors test PPP approach.

The studies of PPP approach have linear and nonlinear models, which are the most popular ones. With the linear model, it can be seen that almost papers use the cointegration test, the Vector Error Correction Model (VECM), or unit root test to check whether or not all variables move together or their means are reverted. In contrast, with the latter, most studies applied the STAR-family model (Smooth Transition Auto Regressive) and then used the unit root test for the real exchange rate in the nonlinear model framework.

### 3. Model specification

#### 3.1. Linear model for PPP approach

The stationary of real exchange rate by using unit root test was tested by Tastan (2005) and Narayan in 2005. At the same time, there was an attempt from Tastan to search for the stationary of real exchange rate between Turkey and four other partners: the US, England, Germany, and Italy. From 1982 to 2003, the empirical result stated non-stationary in the long run between Turkey and the US, Turkey and England as well. While this author just used one single country, Narayan examined 17 OECD countries in which his results were mixed. If he uses currencies based on the US dollar, the three countries, France, Portugal and Denmark, will be satisfied. If the usage of currency is German based, Deutschmark, seven countries will be satisfied. In addition, univariate techniques were applied to find out the equilibrium of the real exchange rate. However, Kremers et al., (1992) argued that that technique might suffer low power against multivariate approach because the deception of improper common factor could be limited in the ADF test.

After Johansen's development of a method of conducting VECM in 1988, there has been various papers applied it to test PPP. Therefore, Chinn (2000) estimated whether the East Asian currencies were overvalued or undervalued with VECM. The results showed that the currencies of Hong Kong, Indonesia, Thailand, Malaysia, the Philippines and Singapore were overvalued.

Besides Chinn, there are many authors using the technique VECM to conduct tests of the PPP theory. There are some papers that have the validity in empirical such as Yazgan (2003), Doğanlar et al.(2009), Kim (2011), Kim & Jei (2013), Jovita Gudan (2016), and some papers does not have the validity such as Basher et al. (2004), Doğanlar (2006).

#### 3.2. Nonlinear model for PPP approach

Baharumshah et al., (2010), Ahmad and Glosser (2011) have applied the nonlinear regression model in recent years. However, Sarno (1999) stated that when we used the STAR model, the presumption of real exchange rate could lead to wrong conclusions.

Developed a new test (KSS test) was developed by Kapetanios et al., (2003) to test unit root for 11 OECD countries, applying the nonlinear Smooth Transition Auto Regressive model. They used monthly data for 41 years from 1957 to 1998 and the US dollar as a numeraire currency. While the KSS test did not accept unit root in some cases, the ADF test provided reverse results, implying that the KSS is superior to ADF test. Furthermore, Liew et al., (2003) used KSS test to check whether RER is stationary in the context of Asia. In his research, the data was collected in 11 Asian countries with quarterly bilateral exchange rate from 1968 to 2001 and US dollar and Japanese Yen represented as the Japanese currencies. The results showed that the KSS test and ADF test conflicted to each other when it comes to the unit root. Particularly, the ADF test can be applied in all cases, whereas the KSS test was not accepted in eight countries with US dollar numeraire and six countries where YEN was considered as a numeraire. The other kinds of unit root test for nonlinear model were applied by Saikkonen and Lutkepöl (2002) and Lanne et al., (2002), then used by Assaf (2006) to test the stability of the real exchange rate (RER) in eight EU countries. They came to the conclusion that there

was no stationary of the RER in the structural breaks after the appearance of the Bretton Woods era, which can be explained that the authorities may interfere with the exchange market to decide its value.

Besides, Baharumshah et al., (2010) attempted to test the nonlinear mean reverting of six Asian countries based on nonlinear unit root test and the STAR model. The authors used quarterly the data from 1965 to 2004 and US dollar as a numeraire currency. This was a new approach to test the unit root of the exchange rate for some reasons. First, real exchange rate was proved to be nonlinear, then the unit root of real exchange rate was tested in nonlinear model. The evidence indicated that RER of these countries were nonlinear, which mean reverting and the misalignment of these currencies should be calculated with US dollar as a numeraire. This evidence may lead to different results with the ADF test for unit root.

## 4. Methodology and data

### 4.1. Methodology

Take the log from the equation (1) we have:

$$\text{Log}(s_t) = \log(p_t) - \log(P_t^*)$$

So when we run regression, the formula is:

$$s_t = c + \alpha_1 p_t + \alpha_2 P_t^* + \varepsilon_t$$

Where:  $s_t$  is the natural log exchange rate in Vietnam,  $p_t$  and  $P_t^*$  the natural log CPI of Vietnam and CPI of the US, respectively.

Because of time series data, the most important issue is that  $s_t$ ,  $p_t$ , and  $P_t^*$  stationary or nonstationary. If the variable is nonstationary, there will be spurious when we run the model

Step 1: Testing  $s_t$ ,  $p_t$ , and  $P_t^*$  stationary or nonstationary by using Augmented Dickey Fuller test. A time series is an Augmented Dickey Fuller test based on the equation below:

$$\Delta Y_t = \beta_1 + \beta_2 t + \beta_3 Y_{t-1} + \sum_{i=1}^n \alpha_i \Delta Y_{t-1} + \varepsilon_t$$

Where:  $\varepsilon_t$  is a pure white noise error term and  $n$  the maximum length of lagged dependent variables.

$$H_0: \beta_3 = 0$$

$$H_1: \beta_3 \neq 0.$$

If the absolute value  $t^*$  exceeds ADF critical value, the null hypothesis could not be rejected, and this result implies that the variable is nonstationary.

If the ADF critical value is greater than the absolute value  $t^*$ , the null hypothesis will fail to reject, and this result suggests the stationary of the variables.

Step 2: Test of cointegration.

Johansen (1988) used the following VAR system to analyze the relationship among variables.

$$\Delta X_t = \Gamma_1 \Delta X_{t-1} + \dots + \Gamma_{k-1} \Delta X_{t-(k-1)} + \Pi X_{t-k} + \mu + \varepsilon_t$$

Where  $X_t$  ( $q, 1$ ) is the vector of observation of  $q$  variables at time  $t$ ,

$\mu$ : the ( $q, 1$ ) vector of constant terms in each equation

$\varepsilon_t$ : ( $q, 1$ ) vector of error terms.  $\Gamma_i$  ( $q, q$ ),  $\Pi$  ( $q, q$ ) are matrices of coefficients.

There were two tests in the Johansen (1988) procedure, which are Trace test and Maximum Eigenvalue to check the vectors cointegration. Trace test can be calculated by the formula as follows:

$$\text{LRtr}(r/k) = -T \sum_{i=r+1}^k \log(1 - \lambda_i)$$

Where  $r$  is the number of cointegrated equation  $r = 0, 1, \dots, k-1$  and  $k$  is the number of endogenous variables.

$H_0$ :  $r$  is the number of cointegrated equations.

$H_1$ :  $k$  is the number cointegrated equations

We can also calculate the maximum Eigenvalue test by the formula below:

$$\text{LRmax}(r/k+1) = -T \log(1 - \lambda)$$

Null hypothesis:  $r$  is the number cointegrated equations

Alternative hypothesis:  $r + 1$  is the number cointegrated equations

After using Johansen (1988) procedure, all the variables will be evaluated to see whether they are cointegration or not. If yes, it can be concluded that the three variables have a long run relationship or one or three variables will come back to the mean.

Step 3: Vector Error Correction Model (VECM)

If there are the cointegrated among the series, the long-term relationship happen; therefore VECM can be applied.

The regression of VECM has the form as follow:

$$\Delta e_t = \delta + \pi e_{t-1} + \sum_{i=1}^{\rho-1} \Gamma_i \Delta e_{t-1} + \varepsilon_t$$

Where  $e_t$ :  $n \times 1$  the exchange rates matrix,  $\pi = \alpha\beta$ :  $\alpha$  is  $n \times r$  and  $\beta$  is  $r \times n$  matrices of the error correction term,  $\Gamma_i$ :  $n \times n$  the short-term coefficient matrix, and  $\varepsilon_t$ :  $n \times 1$  vector of iid errors



If Error Correction Term is negative and significant in sign, there will be a steady long term relative among variables.

Step 4: Measuring misalignment

Using the simple approach that was provided by Stock and Watson (1993), Dynamic Ordinary Least Square (DOLS), to measure the misalignment between Vietnam and the United States. Stock-Watson DOLS model is specified as follows:

$$Y_t = \beta_0 + \beta X + \sum_{j=-q}^p \bar{d}_j \Delta X_{t-j} + u_t$$

Where  $Y_t$ : Dependent variable

X: Matrix of explanatory variables

$\beta$ : Cointegrating vector; i.e., represent the long-run cumulative multipliers or, alternatively, the long-run effect of a change in X on Y

p: lag length

q: lead length

## 4.2. Tables

Nominal exchange rate, the consumer price index of Vietnam and the U.S are in logarithm form. All data spanned monthly from 2010:1 to 2015:12.

**Table 1. Variable definition**

Variables	Variables definition	Sources
S	The nominal exchange rate, which is the number domestic currency units per unit of foreign currency.	ERIC indicator
CPIVN	Consumer price index of Vietnam, year 2010 = 100	IFS & GSO
CPIUS	Consumer price index of U.S, year 2010 = 100	OECD

## 5. Results and discussion

### 5.1. Unit root test

We applied the Augmented Dickey Fuller test to check the stationary of consumer price index of Vietnam (CPIVN) and the U.S (CPIUS) and nominal exchange rate (S) between Vietnam and U.S. All variables have log form. Mackinnon used Eview 8.1 package software as the critical value.

**Table 2. Unit root test for variables**

Variables	ADF			
	At level		At first different	
	t - statistic	p-value	t - statistic	p-value
CPIUS	0.324043	0.9780	-5.544508	0.0000**
CPIVN	1.674693	0.9995	-3.303306	0.0184*
S	0.662047	0.9905	-6.379588	0.0000 **

Note: \*, \*\* indicate significant at 5% and 1% levels respectively.

Table 2 showed the results of unit root test in time series of CPIVN and CPIUS, and the nominal exchange rate (S) between Vietnam and U.S. All variables have their t-statistic greater than the critical value. As a result, they have unit root or nonstationary at level.

On the contrary, the difference between S and CPIUS have the smaller t-statistic than the critical value at 1%. Therefore, S and CPIUS have not unit root or stationary at the first difference. Similarly, the t-statistic of CPIVN was smaller than the critical value at 5% so that was is stationary at the first difference.

As being analyzed above, all the variables are nonstationary at level and stationary at first difference; therefore, they cointegrated at I(1) or at the same order. As a result, Johansen (1988) procedure was examined to investigate the cointegration among these time series.

### 5.2. Optimal lag

We should choose optimal lag before conducting Johansen (1988) procedure. In view package, five lags length criteria have the same power. Therefore, if one lag is dominated by many criterions, this lag will be selected or else every lag is used for every case in VECM.

**Table 3. Lag criteria**

Criterion	LR	FPE	AIC	SC	HQ
Lag	3	3	3	2	3

LR: sequential modified LR test statistic

FPE: Final prediction error

AIC: Akaike information criterion

SC: Schwarz information criterion

HQ: Hannan-Quinn information criterion

Table 3 illustrated the three the criteria, which are LR, FPE and AIC choose lag 3. In other words, 3-lag was chosen for conducting Johansen (1988) procedure or testing cointegration of three variables.

### 5.3. Johansen (1988) procedure for cointegration test

For the reasons, all the variables are cointegrated at the first order I(1), Johansen (1988) cointegration with 3 lags was conducted to test the long run relationship among variables.

**Table 4. Johansen (1988) cointegration equation**

Number of Ccs	Cointegration equation			
	Trace test		Eigenvalue test	
	Statistic	P - valued	Statistic	P - valued
None*	30.34429	0.0432	23.52728	0.0226
At most 1	6.817003	0.5990	6.649302	0.5314
At most 2	0.167701	0.6822	0.167701	0.6822

Table 4 presents the Johansen (1988) cointegration test. The results indicated that both Trace test and Eigenvalue test were statistically significant at 5% (greater than the critical value of 5% or P-valued less than 5%). Hence, the null hypothesis of  $r = 0$  is rejected.  $R = 0$  implies one cointegration equation in the long run, so the VECM can be used for further investigation of variables.

### 5.4. Vector Error Correction Model

**Table 5. The speed of adjustment coefficient of long run**

	Coefficient	Std. Error	t-Statistic	Prob.
C(1)	-0.133156	0.038557	-3.453503	0.0011

The table 5 suggests the long run relationship of PPP between two countries. C(1) has negative in value (-0.133) and significant in sign (Prob = 0.0011), is error correction term. This implies that the variables move along together or have mean reverting. As a result, PPP exists between Vietnam and the U.S.

In conclusion, ADF, Johansen Cointegration and Vector Error Correction Model prove that PPP hold between Vietnam and the U.S. This is a good indicator for policy makers, multinational firms and exchange rate market members to set their plans for future activities.

Measuring the misalignment between Vietnam Dong and the United States Dollar

Because of the existence of PPP between Vietnam and the United States, DOLS approach is used to calculate the

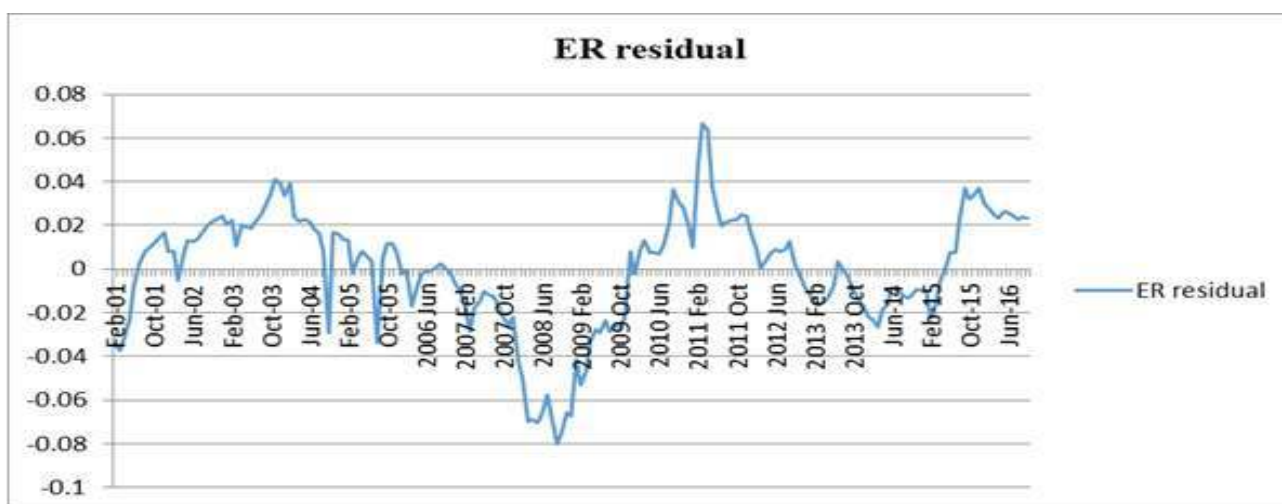

misalignment between two countries.

As can be seen from the graph, the ER residual (the misalignment between VND and USD) was very fluctuated during the whole period of time. In February 2001, this figure was around -0,04 or VND was undervalued 4%, then VND overvalued significantly soared to nearly 2% before falling down to negative zero in the following month. However, this decrease did not last long because it recovered in December and rocketed to reach 4% in November 2003. After that, VND experienced a decreasing time and dipped to the lowest point in September 2008 at about undervalued 8%. Then, it rapidly climbed up and peaked at more than 6% in March 2011 before gradually decreasing and increasing in the following months. After fluctuating, VND finally stood at nearly overvalued 4% in September 2015. In short, the misalignment between VND and USD changed in different periods of time, dived to the lowest point at 8% in September 2008 and overvalued peaked at more than 6% in March 2011.

This paper examines the relationship of Purchasing Power Parity (PPP) between Vietnam and the United States in Johansen cointegration and VECM frameworks. Using monthly data from 2010:1 to 2015:12, the econometrics tests proved that the PPP theory hold between Vietnam and the U.S. After that, DOLS was applied to measuring misalignment between VND and USD. The authors find out the misalignment between two countries very fluctuated and VND is overvalued at present.

## Reference

- [1] Ahmad, Y. & Glosser, S., (2011). "Searching for nonlinearities in real exchange rates". *Applied Economics*, 43(15), pp.1829-1845.
- [2] Asea, P. K. & Corden, W. M., (1994). "The Balassa-Samuelson model: an overview". *Review of international economics*, 2(3), pp.191 – 200.
- [3] Assaf, A., (2006). "Nonstationarity in real exchange rates using unit root tests with a level shift at unknown time". *International Review of Economics and Finance*, 17(2), pp.269–278. doi:10.1016/j.iref.2006.08.008
- [4] Baharumshah, Z. A., Liew, K. V. & Chowdhury, I., (2010). "Asymmetry dynamics in real exchange rates: New results on East Asian currencies". *International Review of Economics and Finance*, 19(4), pp.648–661.
- [5] Balassa, B., (1964). "The Purchasing-Power Parity doctrine: a reappraisal". *Journal of Political Economy*, 72(6), pp.584 – 596. Retrieved from: <http://www.jstor.org/stable/1829464>.
- [6] Basher, S. A. & M. Mohsin., (2004). "PPP Tests in Cointegrated Panels: Evidence from Asian Developing Countries". *Applied Economics Letters*, 11 (3), pp.163-166.
- [7] Chinn, D. M., (2000). "Before the fall: were East Asian currencies overvalued?" *Emerging Market Review*, 1(2), pp.101 – 126. Retrieved from: <http://www.sciencedirect.com/science/article/pii/S156601410000008X>
- [8] Doğanlar, M., (2006). "Long-run Validity of Purchasing Power Parity and Cointegration Analysis for Central Asian Countries". *Applied Economics Letters*, 13 (7), pp.457-461.
- [9] Doğanlar, M., H. Bal & M. Özmen., (2009). "Testing Long-Run Validity of Purchasing Power Parity for Selected Emerging Market Economies". *Applied Economics Letters*, 16 (14), pp.1443-1448.
- [10] Johansen, S., (1988). "Statistical Analysis of Cointegrated Vectors". *Journal of Economic Dynamics and Control*, 12(2-3), pp.231 -254.
- [11] Jovita G., (2016). "Modelling and forecasting exchange rate" *Lithuanian Journal of Statistics*, 55(1), pp.19 – 30.
- [12] Kapetanios, G. Shinb, Y. & Snell, A., (2003). "Testing for a unit root in the nonlinear STAR framework". *Journal of Econometrics*. 112(2), pp.359 – 379.
- [13] Kaminsky, G., Lizondo, S & Reinhart, C. M., (1998). "Leading Indicators of Currency Crises". *IMF Staff papers* 45(1), pp.1 - 48. Retrieved from: <http://www.jstor.org/stable/3867328>.
- [14] Kim, H-G., (2011). "VECM Estimations of the PPP Reversion Rate Revisited". *Journal of Macroeconomics*, DOI: 10.1016/j.jmacro.2011.10.004
- [15] Kim, H-G. & S. Y. Jei, (2013). "Empirical Test for Purchasing Power Parity Using a Time-Varying Parameter Model: Japan and Korea Cases". *Applied Economics Letters*, 20 (6), pp.525-529.
- [16] Kremers, M. J. J., Ericsson, R. J. J. M., & Dolado, J. J., (1992). "The power of cointegration tests". *Oxford Bulletin of Economics and Statistics*, 54(3). doi: 10.1111/j.1468-0084.1992.tb00005.x
- [17] Krugman, R. P., & Obstfeld, M., and Melitz, J. M., (2012). "Price levels and the exchange rate in the long run". In S. Yagan (Ed.), *International Economics theory and policy*, (pp. 385 – 386). Pearson Education.
- [18] Lanne, M., Lütkepohl, H., and Saikkonen, P., (2002). "Comparison of unit root tests for time series with level shifts". *Journal of Time Series Analysis*, 23(6), pp.667–685. Retrieve from: <http://onlinelibrary.wiley.com/doi/10.1111/1467-9892.00285/pdf>
- [19] Narayan, P. K., (2005). "New evidence on purchasing power parity from 17 OECD countries". *Applied Economics*, 37(9), pp.1063-1071.
- [20] Rogoff, K., (1996). *The Purchasing Parity Puzzle*. *Journal of Economic Literature*, 34, pp.647 – 668. Retrieved from: <http://scholar.harvard.edu/rogoff/publications/purchasing-power-parity-puzzle>
- [21] Saikkonen, P., & Lütkepohl, H., (2002). "Testing for a unit root in a time series with a level shift at unknown time". *Econometric Theory*, 18(2), pp.313–348.
- [22] Sarno, L., (1999). "Real exchange rate behavior in the Middle East: a re-examination". *Economics Letters*. 66(2),

pp.127–136.

- [23] Shapiro, C. A., (1983). “What does Purchasing Power Parity mean?” *Journal of International Money and Finance*, 2(3), pp.295 – 318.
- [24] Stock, J. and M. Watson, (1993). “A simple estimator of cointegrating vectors in higher order integrated systems”, *Econometrica* 61(4), pp.783-820.
- [25] Tastan, H., (2005). “Do real exchange rates contain a unit root? Evidence from Turkish data”. *Applied Economics*, 37(17), pp.2037–2053.
- [26] Yazgan, E., (2003). “The Purchasing Power Parity Hypothesis for a High Inflation Country: A Re-Examination of the Case of Turkey”, *Applied Economics Letters*, 10 (3), pp.143-147.

# Financial Supervision Unification and Central Bank Involvement in Supervision: Evidence from Before and After 2008 Global Financial Crisis

Pham Thi Thuy Diem<sup>a,1</sup>

<sup>a</sup>Banking University Ho Chi Minh city (PhD candidate at University of Economics Ho Chi Minh City), 36 Ton That Dam Street, District 1, Ho Chi Minh city, Vietnam

## ABSTRACT

The structure of financial supervision has received wide attention from policymakers over the past decade. The present study was undertaken to provide empirical evidence on the association between supervision unification and central bank involvement. Using ordered Logit and ordered Probit functions for 47 countries before and after the 2008 global financial crisis, the findings suggest that the central bank involvement did not influence the degree of supervision unification before the Crisis – 2006. However, the involvement of central bank had a positive impact on degree of supervisory unification after the Crisis – 2013. In addition, our results imply that the impact of controlled variables may vary between before the Crisis – 2006 and after the Crisis – 2013. Before the Crisis – 2006, the supervision unification depended on the index of good governance, the ratio of stock market capitalization to GDP, and geographical dummies (Europe). In contrast, the indicator of financial system structure, the index of good governance, and the legal origin of country were three controlled variables which influenced the supervision unification.

**Keywords:** The structure of financial supervision; supervision unification; central bank involvement; the single financial authority.

## 1. Introduction

The structure of financial supervision has traditionally been a central issue in the agenda of finance and banking research. There are many studies examining the impact of the structure of financial supervision like central bank independence, central bank involvement in supervision and supervisory unification on bank performance and stability (e.g. Barth et al., 2003; Gaganis and Pasiouras, 2013; Doumpos et al., 2015; Tabak et al., 2016). However, research on the relationship between the degree of financial supervision unification and the role of the central bank has received considerably less attention.

Up to date, only a couple of studies have focused on this topic using descriptive analysis (e.g. Masciandaro, 2004, 2007, 2009; Masciandaro et al., 2009). Hence, these studies focus on analyzing the trade off between central bank involvement in supervision and supervisory unification at a time. Nonetheless, as mentioned in Masciandaro and Quintyn (2009), many countries are considering reforms in their supervisory structure in the wake of the 2008 global financial crisis. The present study aims to close the aforementioned gap in the literature, by investigating whether and how financial supervision unification is influenced by central bank involvement in supervision.

Using a sample of 47 countries over the period before and after the 2008 global financial crisis, the present study analyses the trade off between central bank involvement in supervision and supervisory unification. To investigate the impact of central bank involvement in supervision on financial supervision unification, the paper uses ordered Logit and ordered Probit functions while controlling for various country-specific characteristics. These data suggest that the central bank involvement did not influence the supervision unification before the Crisis – 2006. However, the involvement of central bank had a positive and significantly impact on degree of supervisory unification after the Crisis – 2013.

The rest of the paper is as follows. Section 2 provides a background discussion. Section 3 describes the data and methodology. Section 4 discusses the empirical results, and Section 5 concludes the study.

## 2. Background discussion

Masciandaro (2007) stated that financial supervision unification and central bank involvement in supervision were not determined simultaneously through the political process. In a given country, we assume that the policymakers must decide whether to set up a unified supervision because of the blurring process in the financial sectors. Consequently, the

\* Corresponding author. Tel.: +841696320258.  
E-mail address: diem.ptt@vnp.edu.vn

degree of central bank involvement in supervision may be low or high in that country.

Let us first consider the case where the degree of central bank involvement in supervision is low. It is explained that the policymakers may not wish to involve the role of central bank in supervisory to avoid moral hazard phenomenon in the controlled intermediaries, which is called “moral hazard effect”. Or the policymakers may not wish to strengthen the bureaucratic powers of the central bank because it is already responsible for monetary policy, which is called “bureaucracy effect”. Hence, if central bank is not responsible for supervising the financial markets, the policymakers will strengthen the current role of the central bank in terms of supervisory duties, and the supervision unification degree can be raised by creating a single financial authority (Masciandaro, 2007, 2009).

If the central bank is mainly responsible for supervising, the policymakers may increase the supervision concentration degree may be increased by one of two ways: (i) increasing the powers of the central bank or (ii) unifying them in the hands of a single financial authority. Again, the policymakers might be afraid the spreading of the safety net if the central bank is also involved in supervising insurance and securities sectors, which is called “moral hazard effect”. In addition, the policymakers might be afraid the creation of an overly powerful bureaucratic agency, which is called “bureaucracy effect”. Thus, they may refuse the idea of further increasing the central bank involvement (Masciandaro, 2007, 2009).

At the same time, if the policy of the central bank has been effective, which is called “reputation endowment effect”, the policymakers may not reduce the degree of the central bank involvement in supervision, or may not regard it as advisable. Because the policymakers have decided neither to reduce nor increase central bank involvement, they also decide not to increase the degree of supervision unification. Consequently, in such cases, if the central bank is mainly responsible for supervising, there is a trend not to increase the degree of supervision unification. On the other hand, if the central bank’s reputation is tenuous or declining, the establishment of a single financial authority might be the more likely choice (Masciandaro, 2007, 2009). In summary, the degree of central bank involvement in supervision may be the condition that policymakers make their decision to alter the degree of supervisory concentration. As a result, there is a trade off between supervision unification and central bank involvement.

Several studies attempt to establish a relationship between the degree of financial sector unification and the role of the central bank. However, research on the impact of central bank involvement in supervision on financial supervision unification remains scarce. Masciandaro (2007) examined whether and how the role of the central bank influenced the unification of the overall financial supervision architecture. Using ordered logit and probit regressions on a dataset of 89 countries, the results showed that the position of the central bank decided the degree of unification in supervision. In addition, if the reputation of central bank and its involvement in supervision were high, the degree of financial sector unification was likely to be low, and vice versa. There were three possible channels could explain the central bank fragmentation effect including moral hazard, bureaucracy, and reputation endowment effects. Masciandaro (2009) investigated the robustness of the central bank involvement in supervision in explaining the recent trend in supervision consolidation, employing ordered Logit and ordered Probit functions on an updated dataset. The findings stated that the supervision unification was mainly influenced by the quality of public sector governance. The “good” policymakers would prefer the single financial authority outside the central bank if the correspondent welfare gains were closely related to at least one of the three effects: (i) moral hazard; (ii) conflict of interest; (iii) bureaucracy - were considered high. The “bad” policymakers would choose a unified financial authority if the financial sectors liked it, and the central bank was not a captured one. Masciandaro et al. (2009) considered current trends in reforms of the supervisory architecture of each of the 27 European Union (EU) countries and evaluated their degree of institutional convergence. Using descriptive analysis, the results showed that there was no single superior model of bank supervision while the degree of supervisory convergence was low. The objective of Masciandaro (2004) was to analyse world-wide trends in financial supervision architectures. The paper showed that there was a trade off between the degree of financial supervision unification and the central bank involvement in supervision. The blurring hazard effect and the monopolistic bureau effect were two possible explanations of this relationship.

### 3. Methodology and data

#### 3.1. Methodology

In order to examine the impact of central bank involvement in supervision on financial supervision unification, this study follows Masciandaro (2007). The general specification is represented by Eqs. (1):

$$\begin{aligned} (FSU)_i = & \alpha_0 + \alpha_1(CBFA)_i + \alpha_2(MvB)_i + \alpha_3(mcap)_i + \alpha_4(goodgov)_i + \alpha_5(gdp)_i \\ & + \alpha_6(OECD)_i + \alpha_7(Europe)_i + \alpha_8(SandinavianL)_i + \alpha_9(GermanL)_i + \alpha_{10}(SocialistL)_i \\ & + \alpha_{11}(FranceL)_i + \alpha_{12}(LatitudeL)_i + \varepsilon_i \end{aligned} \quad (1)$$

Where country  $i = 1 \dots 47$ ;  $(FSU)_i$  refers to index of supervision unification;  $(CBFA)_i$  refers to index of central bank’s involvement in financial supervision;  $(MvB)_i$  refers to dummy variable that expresses bank-based versus market-based countries;  $(mcap)_i$  refers to stock market capitalization to GDP (%);  $(goodgov)_i$  refers to index of good governance;  $(gdp)_i$  refers to gross domestic product;  $(OECD)_i$  refers to dummy variable that expresses whether a given country is a member of the OECD or not;  $(Europe)_i$  refers to dummy variable that expresses whether a given country is European or not;  $(SandinavianL)_i$  refers to dummy variable that signals whether the legal origin of a given country is Sandinavian or not;  $(GermanL)_i$  refers to dummy variable that signals whether the legal origin of a given country is German or not;  $(SocialistL)_i$  refers to dummy variable that signals whether the legal origin of a given country is

Socialist or not; (Latitude)<sub>i</sub> refers to the latitude of the country;  $\mathcal{E}_i$  is an error term.

Because FSU is a dependent variable which is ordered categories, Eqs. (1) is estimated with ordered Logit model and ordered Probit model following Masciandaro (2007, 2009). Note that as we excluded EnglishL in Eqs. (1) to avoid dummy trap, the estimations were interpreted by comparing the one of EnglishL. We also controlled for country-specific variables including MvB, mcap, goodgov, gdp, OECD, Europe, Law, and Latitude.

### 3.2. Data

Data have been collected country by country, using official documents and web sites. Our final sample consists of 47 countries for which complete data and 90 countries for FSU and CBFA data for 2006 and 2013. This results in an balanced dataset of 658 country-specific observations for each year.

All country-specific variables were collected from the World Bank database and The World FactBook (Central Intelligence Agency). Specifically, data for financial supervisory architecture variables (FSU, CBFA) were constructed by Melecky and Podpiera (2013) from the World Bank database on the Organization of Financial Sector Supervision. Data for the indicators of financial system structure (MvB) and stock market capitalization to GDP (mcap) were obtained from Financial Development and Structure Dataset (World Bank). Data for the six dimensions of governance and gross domestic product (GDP) was collected from Worldwide Governance Indicators (World Bank) and Financial Development and Structure Dataset (World Bank), respectively. Information for dummy variables (OECD, Europe, Latitude) were obtained from World FactBook (CIA). Finally, Information for legal origin of countries were constructed by Easterly (2001) from Global Development Network Growth Database. For a description of variables, see Table 1.

**Table 1. Definition of variables.**

Variable	Description	Source
Dependent variable		
FSU	Index of supervision unification. It takes the following values: 4 = there is a single authority for all three sectors (total number of supervisors = 1); 3 = there is a single authority for banking and securities (total number of supervisors = 2); 2 = there is a single authority for insurance and securities or insurance and banking (total number of supervisors = 2); 1 = there is a specialized authority for each sector (total number of supervisors = 3) (Masciandaro, 2004, 2005, 2006).	Author's calculations based on information from the World Bank database on the Organization of Financial Sector Supervision constructed by Melecky and Podpiera (2013)
Independent variables		
CBFA	Index of central bank's involvement in financial supervision. It takes the following values: 1 = the central bank is not assigned the main responsibility for banking supervision; 2 = the central bank has the main or sole responsibility for banking supervision; 3 = the central bank has responsibility in any two sectors; 4 = the central bank has responsibility in all three sectors (i.e. insurance, securities, banking) (Masciandaro, 2004, 2005, 2006).	Author's calculations based on information from the World Bank database on the Organization of Financial Sector Supervision constructed by Melecky and Podpiera (2013)
MvB	Bank-based versus market-based countries. This index is built following Demirguc-Kunt and Levine (1999), Deltuvaitė and Sinevičienė (2014). $MvB = \frac{PCR}{STM + PRB + PUB}$ Where PCR refers to private credit by deposit money banks and other financial institutions to GDP in country i; STM refers to stock market capitalization to GDP in country i; PRB refers to private bond market capitalization to GDP in country i; PUB refers to public bond market capitalization to GDP in country i. MvB takes the following values: 2 when MvB > 1.1 [Bank-based financial system]; 1 when MvB = [0.9; 1.1] [mixed financial system]; 0 when MvB < 0.9 [Market-based financial system].	Financial Development and Structure Dataset, World Bank
mcap	Stock market capitalization to GDP (%)	Financial Development and Structure Dataset, World Bank
goodgov	The index of good governance. This index is built using all the indicators proposed by Kaufmann et al. (2004). For every country, this research calculates the	Worldwide Governance Indicators, World Bank

	mean of the six dimensions of governance: (i) voice and external accountability; (ii) political stability and lack of violence; (iii) government effectiveness; (iv) lack of regulatory burden; (v) rule of law; (vi) control of corruption.	
gdp	Gross domestic product. This quantitative variable is relevant to economic size factor.	World Development Indicators, World Bank
OECD	Dummy variable that expresses whether a given country is a member of the OECD or not.	World FactBook, CIA
Europe	Dummy variable that expresses whether a given country is European or not.	World FactBook, CIA
Law	Legal origin of countries including Scandinavian, German, Socialist, English, and France. See Beck et al. (2001) for details.	Global Development Network Growth Database constructed by Easterly (2001)
Latitude	The variable is estimated as the absolute value of the latitude of the country. It takes values between 0 and 1. See Beck et al. (2001) for details.	World FactBook, CIA

**4. Empirical results**

**4.1. Descriptive analysis**

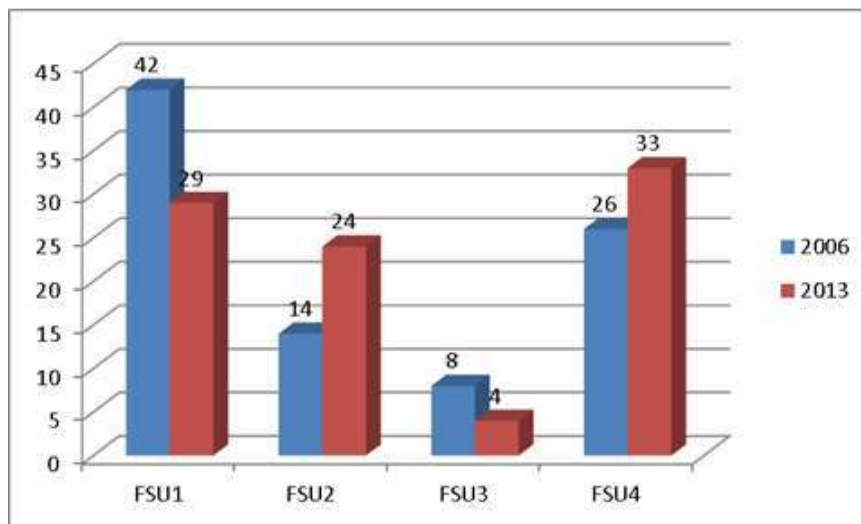

**Figure 1. FSU index description.**

Using the FSU index, Fig. 2 and Table 2 present the situation before and after the 2008 global financial crisis. Before the Crisis – 2006, blue bars – the degree of supervision unification was on average lower than for after the Crisis – 2013 (red bars): 2.53 versus 2.81. Before the Crisis – 2006, there were 56 countries with a low consolidation of supervision (FSU was equal to 1 or 2). On the contrary, there were 34 countries that established a single financial authority with a high level of supervision consolidation (FSU was equal to 3 or 4). After the Crisis – 2013, there were 53 countries with a low consolidation of supervision (FSU was equal to 1 or 2). In contrast, there were 37 countries that established a single financial authority with a high level of supervision consolidation (FSU was equal to 3 or 4).

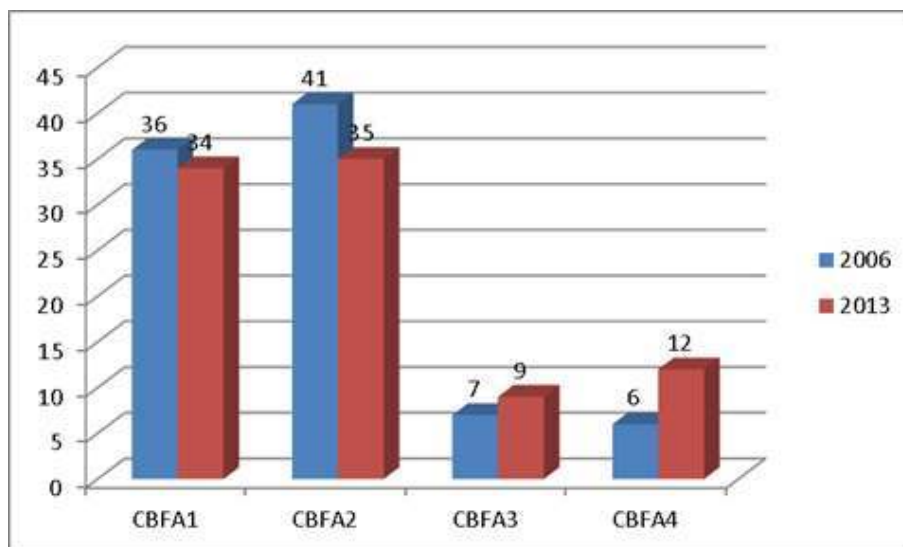

**Figure 2. CBFA index description.**



Figure 2 and Table 2 show the changes in the CBFA Index before and after the 2008 global financial crisis. Before the Crisis – 2006, blue bars – the degree of central bank’s involvement in financial supervision was on average lower than for after the Crisis – 2013 (red bars): 1.77 versus 1.98. Before the Crisis – 2006, there were 54 countries that the central bank was not the main supervisor (CBFA was equal to 2, 3, and 4), while there were 36 countries the central bank was not assigned the main responsibility for banking supervision (CBFA was equal to 1). After the Crisis – 2013, there were 56 countries that the central bank was not the main supervisor (CBFA was equal to 2, 3, and 4), while there were 34 countries the central bank was not assigned the main responsibility for banking supervision (CBFA was equal to 1). All descriptive statistics are reported in Tables 1.

**Table 2. Description results.**

Variable	Mean <sup>b</sup>	Mean <sup>a</sup>	Std. Dev. <sup>b</sup>	Std. Dev. <sup>a</sup>	Min <sup>b</sup>	Min <sup>a</sup>	Max <sup>b</sup>	Max <sup>a</sup>
Fsu	2.53	2.81	1.36	1.36	1	1	4	4
Cbfa	1.77	1.98	0.91	1.11	1	1	4	4
mybindex	0.17	0.43	0.52	0.77	0	0	2	2
Mcap	92.54	87.96	107.59	156.70	5.91	4.88	714.66	1073.85
goodgov	0.75	0.74	0.82	0.79	-0.75	-0.72	1.88	1.86
Gdp	915035	1410877	2134079	2820612	6760	10131	13900000	16691517
Oecd	0.45	0.45	0.50	0.50	0	0	1	1
europa	0.57	0.57	0.50	0.51	0	0	1	1
scandinavian	0.11	0.11	0.31	0.31	0	0	1	1
german	0.11	0.11	0.31	0.31	0	0	1	1
socialist	0.17	0.17	0.38	0.38	0	0	1	1
french	0.36	0.36	0.49	0.49	0	0	1	1
english	0.26	0.26	0.44	0.44	0	0	1	1
latitude	0.41	0.41	0.198	0.19	0.01	0.01	0.72	0.72

Note: <sup>b</sup>, <sup>a</sup> denote before the Crisis – 2006 and after the Crisis – 2013, respectively.

#### 4.2. Empirical results

Table 3 and Table 4 present the correlation coefficients of the variables used as determinants of the degree of supervision unification for before the Crisis – 2006 and after the Crisis – 2013. For example, the correlations between the two main variables of interest for before and after the 2008 global financial crisis were -0.12 (FSU and CBFA) and 0.02 (FSU and CBFA), respectively. These results emphasized that the correlation coefficients did not suggest multicollinearity problems. This research included all the interactions in the regression due to low correlation (correlation coefficients < 0.8).

Table 5 shows the estimations of the influence of central bank involvement in supervision and controlled variables on supervisory unification for before the Crisis – 2006 and after the Crisis – 2013, based on Masciandaro (2007).

Before the Crisis - 2006, we start using the central bank involvement in supervision as a proxy of its influence in our estimation. The first result did not find a significant relationship between supervision unification and central bank involvement. This evidence did not support the view that there was a trade off between supervision unification and central bank involvement (Masciandaro, 2004, 2007, 2009). Looking at the controlled variables, our results highlight a relationship between the index of good governance and the degree of supervision unification. This variable was positive and highly significant. Many of the studies stressed the importance of the characteristics of the good governance as determinants in the choice for a total or partial unification of the supervisory regimes (Masciandaro, 2007, 2009). In addition, the probability that a country could move toward a single financial authority was higher if the ratio of stock market capitalization to GDP was smaller. Finally, in order to test the possible presence of some sort of “mimic effect” among neighbouring countries, we used a dummy for Europe. Geographical dummies were also considered to interpret the existence of international agreements between countries which may influence their national behaviour. The geographical testing supports the endowment view (Beck et al., 2001). According to Beck et al. (2001), historically, lands with high rates of disease and inhospitable conditions are not able to support the overall institutional development, which improves the quality of the financial structures. These results indicated that the choice of the degree of supervisory unification was influenced by the European continent. More specifically, if Europe variable expresses a given country is European, it seems that the probability of consolidation will decrease.

Table 3. Correlation matrix (year 2006).

	FSU	CBFA	MvB index	mcap	goodgov	GDP	OECD	Europe	Scandinavian	German	Socialist	French	Latitude
FSU	1.00												
CBFA	-0.12	1.00											
MvB index	-0.10	0.13	1.00										
Mcap	-0.06	0.06	-0.12	1.00									
goodgov	0.55	-0.00	-0.04	0.35	1.00								
GDP	-0.09	-0.02	-0.13	0.04	0.16	1.00							
OECD	0.22	0.04	0.04	-0.05	0.57	0.21	1.00						
Europe	0.24	0.06	0.12	-0.17	0.50	-0.15	0.60	1.00					
Scandinavian	0.32	-0.14	0.02	0.06	0.44	-0.11	0.11	0.30	1.00				
German	0.32	-0.29	-0.11	0.04	0.26	0.15	0.11	0.02	-0.12	1.00			
Socialist	-0.09	0.24	0.40	-0.24	-0.20	-0.14	0.05	0.28	-0.16	-0.16	1.00		
French	-0.20	-0.05	-0.25	-0.26	-0.39	-0.10	-0.14	-0.16	-0.26	-0.26	-0.34	1.00	
Latitude	0.35	-0.11	0.10	-0.09	0.57	0.07	0.54	0.78	0.49	0.13	0.27	-0.31	1.00

Table 4. Correlation matrix (year 2013).

	FSU	CBFA	MvB index	mcap	goodgov	GDP	OECD	Europe	Scandinavian	German	Socialist	French	Latitude
FSU	1.00												
CBFA	0.02	1.00											
MvB index	-0.13	-0.04	1.00										
mcap	-0.15	0.03	-0.22	1.00									
goodgov	0.46	-0.04	-0.01	0.20	1.00								
GDP	-0.24	-0.06	-0.02	-0.01	-0.02	1.00							
OECD	0.16	0.17	0.00	-0.16	0.52	0.09	1.00						
Europe	0.29	0.22	0.37	-0.27	0.48	-0.25	0.60	1.00					
Scandinavian	0.31	-0.31	0.26	-0.08	0.45	-0.13	0.11	0.30	1.00				
German	0.31	-0.31	-0.19	0.00	0.28	0.11	0.11	0.02	-0.12	1.00			
Socialist	0.06	0.32	0.34	-0.18	-0.20	0.03	0.05	0.28	-0.16	-0.16	1.00		
French	-0.16	-0.11	-0.13	-0.17	-0.38	-0.14	-0.14	-0.16	-0.26	-0.26	-0.34	1.00	
Latitude	0.34	0.08	0.34	-0.22	0.54	-0.00	0.54	0.78	0.49	0.13	0.27	-0.31	1.00

However, after the Crisis - 2013, the findings of the estimates show that the probability of a single financial authority was no always inversely related to the central bank involvement in supervision. In contrast Masciandaro (2004, 2007, 2009) found, the involvement of central bank had a positive impact on degree of supervisory unification. Considering the controlled variables, the probability that a country could move toward a single financial authority model is higher: 1) the smaller the indicator of financial system structure; 2) the higher the index of good governance; 3) when the jurisdiction adopts the legal origin of country, particularly if the legal framework was characterized by Socialist and French roots. These results (1,3) were not in line with previous evidence found by Masciandaro (2007, 2009), in which the indicator of financial system structure, and Socialist and French roots did not ensure mores degree of supervisory unification.

**Table 5. Choice supervisory unification before and after 2008 crisis – ordered Logit and ordered Probit estimations.**

	Before crisis (year 2006)		After crisis (year 2013)	
	Ologit	Oprobit	Ologit	Oprobit
CBFA	-0.16 (0.43)	-0.07 (0.24)	0.84* (0.48)	0.53* (0.30)
MvB index	-0.75 (0.72)	-0.44 (0.41)	-1.29* (0.73)	-0.82* (0.44)
mcap	-0.75** (0.01)	-0.01** (0.01)	-0.01 (0.00)	-0.003 (0.00)
goodgov	3.40*** (1.06)	1.89*** (0.51)	2.31** (0.94)	1.44** (0.56)
GDP	-0.0000004 (0.0000003)	-0.0000002 (0.0000002)	-0.0000005 (0.0000005)	-0.0000003 (-0.0000003)
OECD	-0.77 (1.05)	-0.39 (0.62)	-1.31 (1.25)	-0.85 (0.74)
Europe	-2.59* (1.62)	-1.28* (0.84)	-0.50 (1.63)	-0.23 (1.00)
Scandinavian	-0.23 (1.86)	0.04 (1.02)	20.23 (4339.45)	7.08 (610.49)
German	1.21 (1.56)	0.94 (0.94)	20.42 (4544.57)	6.96 (638.63)
Socialist	0.43 (1.48)	0.20 (0.88)	3.34** (1.60)	2.14** (0.94)
French	-0.04 (1.06)	-0.11 (0.62)	1.87* (1.06)	1.17* (0.65)
Latitude	1.97 (3.98)	0.74 (2.23)	-1.02 (3.91)	-0.82 (2.30)
LR chi2(12)	32.51	32.90	37.73	38.43
Prob > chi2	0.0012	0.0010	0.0002	0.0001

Note: \*\*\*, \*\*, \* denote statistical significance at 1%, 5%, and 10%.

## 5. Conclusions

The structure of financial supervision has received wide attention from policymakers over the past decade. As a result a number of questions have emerged, such as: Is there a trade off between supervision unification and central bank involvement? Whether and how the role of the central bank influences the unification of the overall financial supervision architecture? Which determines the degree of supervision unification?

The empirical evidence on the topic focused mostly on descriptive data analysis. Only more recently a handful number of papers have investigated the impact of central bank involvement in supervision on financial supervision unification using econometrics. The present study aimed to add to this literature by providing empirical evidence on the association between supervision unification and central bank involvement.

This paper presents and studies a new dataset of the financial supervisory structures and their evolution before the Crisis – 2006 and after the Crisis – 2013 for 98 countries. Using ordered Logit and ordered Probit functions, the results of this study could be of interest to both policymakers and supervisory authorities. First, they suggest that the central bank involvement did not influence the supervision unification before the Crisis – 2006. However, the involvement of central bank had a positive impact on degree of supervisory unification after the Crisis – 2013. Second, our results imply that the impact of controlled variables may vary between before the Crisis – 2006 and after the Crisis – 2013. Before the Crisis – 2006, the supervision unification depended on the index of good governance, the ratio of stock market capitalization to GDP, and geographical dummies (Europe). In contrast, the indicators of financial system structure, the index of good governance, and the legal origin of country were three controlled variables which influenced the supervision unification.

## References

- [1] Barth, J. R., Nolle, D. E., Phumiwasana, T., & Yago, G. (2003). A cross-country analysis of the bank supervisory

- framework and bank performance. *Financial Markets, Institutions & Instruments*, 12(2), 67-120.
- [2] Beck, T., Demirgüç-Kunt, A., & Levine, R. (2001). *Law, politics, and finance* (Vol. 2585). World Bank, Development Research Group, Finance.
- [3] Deltuvaitė, V., & Sinevičienė, L. (2014). Research on the relationship between the structure of financial system and economic development. *Procedia-Social and Behavioral Sciences*, 156, 533-537.
- [4] Demirguc-Kunt, A., Levine, R., 1999. *Bank Based and Market Based Financial Systems: Cross Countries Comparisons*. Policy Research Working Paper Series, vol. 2143. World Bank, Washington D.C.
- [5] Doumpos, M., Gaganis, C., & Pasiouras, F. (2015). Central bank independence, financial supervision structure and bank soundness: An empirical analysis around the crisis. *Journal of Banking & Finance*, 61, S69-S83.
- [6] Gaganis, C., & Pasiouras, F. (2013). Financial supervision regimes and bank efficiency: International evidence. *Journal of Banking & Finance*, 37(12), 5463-5475.
- [7] Kaufmann, D., Kraay, A., & Mastruzzi, M. (2004). Governance matters III: Governance indicators for 1996, 1998, 2000, and 2002. *The World Bank Economic Review*, 18(2), 253-287.
- [8] Masciandaro, D. (2004). Unification in financial sector supervision: The trade-off between central bank and single authority. *Journal of Financial Regulation and Compliance*, 12(2), 151-169.
- [9] Masciandaro, D. (2007). Divide et impera: Financial supervision unification and central bank fragmentation effect. *European Journal of Political Economy*, 23(2), 285-315.
- [10] Masciandaro, D. (2009). Politicians and financial supervision unification outside the central bank: Why do they do it?. *Journal of Financial Stability*, 5(2), 124-146.
- [11] Masciandaro, D. (Ed.) (2005), *Handbook of Central Banking and Financial Supervision in Europe*, Edward Elgar, Cheltenham.
- [12] Masciandaro, D., & Quintyn, M. (2009). Regulating the regulators: the changing face of financial supervision architectures before and after the crisis. *Eur. Company L.*, 6, 187.
- [13] Masciandaro, D., Nieto, M., & Quintyn, M. (2009). Financial supervision in the EU: is there convergence in the national architectures?. *Journal of Financial Regulation and Compliance*, 17(2), 86-95.
- [14] Melecký, M., & Pruteanu-Podpiera, A. (2012). *Institutional structures of financial sector supervision, their drivers and emerging benchmark models*. University Library of Munich, Germany.
- [15] Tabak, B. M., Fazio, D. M., Karine, C. D. O., & Cajueiro, D. O. (2016). Financial stability and bank supervision. *Finance Research Letters*, 18, 322-327.

# Rethinking about Vietnam Educational Reform in The Context of The Fourth Industrial Revolution

Thang Duong Duc<sup>a\*</sup>, Hong Nguyen Anh<sup>b</sup>

<sup>a</sup> Department of International finance, Academy of Finance\*

Number 1, Le Van Hien street, Duc Thang precinct, Bac Tu Liem district, Hanoi, Vietnam

<sup>b</sup> Vietnam Academy of Social Sciences

Number 1, Lieu Giai street, Ba Dinh district, Hanoi, Vietnam

## ABSTRACT

This research is not only show the backward of Vietnam educational system in present but also shows the reason why our education is out of date compared to the world. Because of the poor performance combined with the pressure of the fourth industrial revolution, based on the analytical framework of Tushman and Romanelli on the organizational behavior, we give the prediction about a revolution in Vietnam reform to catch up with the growth of international education.

**Keywords:** the fourth industrial revolution; Vietnam; education system; reform.

## 1. Introduction

Currently in Vietnam, each year, more than 200,000 students who graduated do not find work, while more than 500,000 positions in businesses that are "short" human. Even people graduating excellent, masters, doctors still can't get the job that makes them happy. So, what is wrong?

First, I present the development history of Vietnam educational system, which also partly explained why we have this system nowadays. After that, this research will compare current state of Vietnam education and the trend of education in the world to present that our education system is a little out of date. And at last, based on the analytical framework of Tushman and Romanelli, we show that the poor performance and the force of the industrial revolution will play important role to transform Vietnam education in recent years.

## 2. Literature Review

R. Halverson and A. Collins (2010) argued on the advantage and disadvantage of new technology that brings radical opportunities but also significant challenges to the education system. While, these technologies were predicted to shape a new system of education, the urgency of seeking of coherent model for the future of education in a technological age was stressed. [1]

Ilkka Tuomi and Riel Miller (2011) discussed history of international educational system with the aim of understanding the future, focusing on the foundations of the system. Existing educational institutions and economic, social and political is turning into a conflict. New model of value production will transform both the industrial system of production and the societal requirements for education. They conclude that the emerging society in present need less schooling and educational policies need to be based on redefined aims, objectives, and institutions of education. [8]

Joseph Murphy (2013), by providing an overview of Tushman and Romanelli's model that guides his analysis of change in schools over the last 125 years, showed how one major revolution produced an understanding of schooling, that defined the practice of education throughout the industrial era.[5].

\* Corresponding author. Tel.: +84 987869252.  
E-mail address: duongducthang@hvtc.edu.vn

### 3. Analytical Framework

In this research, we continue using the analytical framework of Tushman and Romanelli who built up their original theory of organizational evolution to explain how the fourth industrial revolution and less effective performance have important impacts on Vietnam education reform.

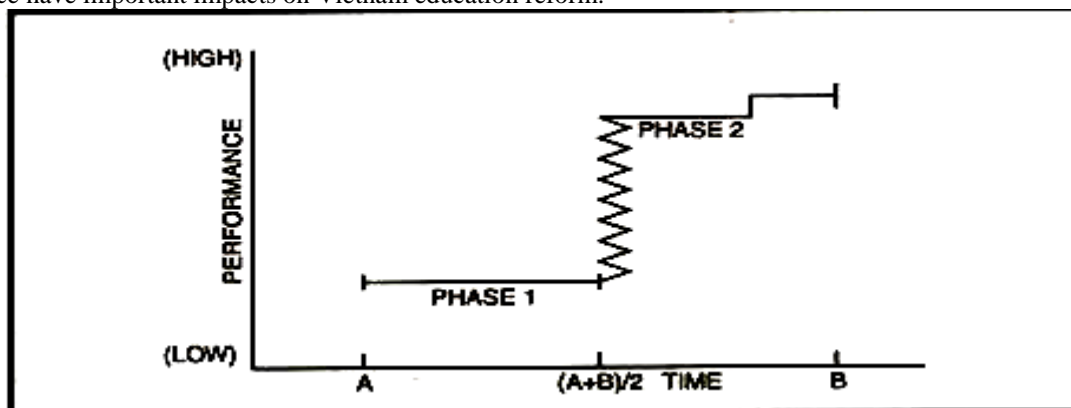

The Punctuated Equilibrium Model

The Punctuated Equilibrium Model developed by Tushman and Romanelli says that organisations have long periods of stability which are alerted by radical changes in the face of an environmental changes. In their research, Tushman and Romanelli (1985) pay special attention on the influence of environmental movements on the shape and functioning of institutions. At the core of the model, Tushman and Romanelli hypothesize that “organizations progress through convergent periods punctuated by reorientations which demark and set the bearings for the next convergent period” (p.173). According to the theory, convergent periods cover long time spans during which incremental and marginal shifts that refine and elaborate organizational elements (e.g., goals) toward increased alignment dominate. Reorientations, on the other hand, encompass “periods of discontinuous change where strategies, power, structure, and systems are fundamentally transformed toward a new basis of alignment” (p. 173). [9]

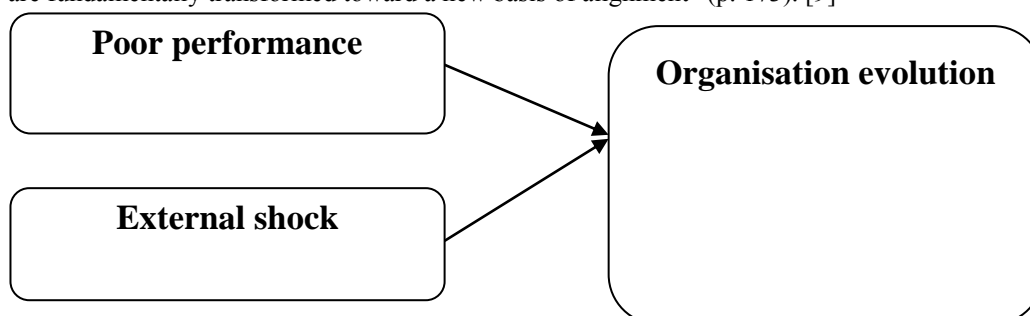

In other words, industries and organizations within them tend to go along for extensive periods of time with only marginal changes. Then, for some external shocks such as social, legal, cultural, political, economic and technological shifts in the environment which impact to the system, that causes the radical change. Tushman and Romanelli (1985) also conclude that a sustained period of poor performance can induce disturbances and demand transformation [9].

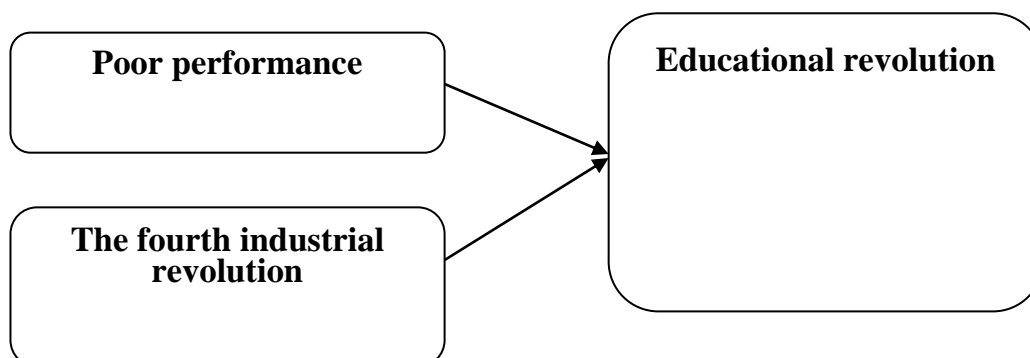

In our research, we review Vietnam educational system in term of history. Compared to international education, our system hasn't kept up with the current trend in the world. For example, when many educators saw the drawbacks of STEM and mass education, Vietnam is trying to repeat that mistakes. Consequences, a lot of students after graduating can not find a satisfied jobs while many companies are short of mankind. Another factor we analyse is the impacts of the fourth industrial revolution on education. The fourth industrial revolution is predicted to cause many problems for

developing countries such as Vietnam. Education reform will be considered as a key for Vietnam to react to the challenge of that.

#### **4. Vietnam education history.**

One way to consider the present state of schools is to contrast where we are with where we have been. In order to have a comprehensive view of the education system in Vietnam, it is necessary to understand the history of the formation and development of the education sector. The development history of the education sector can be divided into three main stages: Confucian Institutions, Colonialism, Anti-colonialism (1906 - 1945) and from State Formation to now.

##### **4.1. Confucian Institutions**

Confucian learning and all its accompanying elements still took deep roots in Vietnamese society in the early decades of XX century. Jonathan D. London (2011) give an definition about Confucianism that “Confucian institutions imposed constraints by linking organized education and the study of classics to governance and authority relations. Confucian ideals and institutions shaped attitudes and behaviors concerning education, but in non-determinant ways, contingent on actors' interests, capacities, and circumstances”. Speaking in a simple way, education focused on moral [4]. Tran Thi Phuong Hoa (2009) claimed that “The first and foremost moral lesson of the all three classes was duties. Family duty was considered the most important virtue. A man should show obligation towards all family members: parents, grandparents (obedience, respect, gratitude), brothers, sisters (love and defend each other), uncles, aunts, cousins, siblings (politeness, kindness). In addition, he must have obligation to teachers (obedience, respect), friends, colleagues (friendship, helpfulness). Moreover, he was supposed to have obligation to his servants, maids (politeness, kindness). A man was placed in a matrix of relations and he was trained to behave well and correctly” [3].

Confucianism is associated with the veneration of education and its development occurred in an age where access to education was limited. Girls and women were largely excluded and those who did receive instruction in the classics were mostly expected to learn and recite certain "virtues of feminine behavior", such as how to stand and sit, speak, cook and sew, and submit to male authority. Boys, in the contrast, had a standard and fairly extensive syllabus of Confucian classics they were expected to master. Up until the nineteenth century, education in Vietnam occurred largely in privately run village schools led by Confucian scholars, who trained local candidates - always boys or men. Beyond the village schools were state-sponsored prefectural schools, provincial schools, and the imperial college. The proportionately small number of people involved in formal studies meant that education took place through other means, especially through oral traditions, such as songs, storytelling, and epic poems. The organized study of Confucian classics and the regular conduct of competitive examinations [4]. During the period, in the context of lack of textbooks, when students owned only a reading book, other materials were mostly supplied by the teachers [3].

##### **4.2. Colonialism**

As soon as the French conquered Vietnam, they planned to set up their educational system, starting with schools for teaching French to Vietnamese and Vietnamese to French, in addition to missionary schools, which existed much earlier to train Vietnamese for religious purposes. During this period, the purpose and content of the training had changed considerably, not only focus on training moral man but also “attempt to build a newly economic and industrial man” [3]. Tran Thi Phuong Hoa (2009) showed that “The mixed Confucian and Western aesthetics were aiming at creating a moral individual with strong sense of duty, submissive characters on the one hand and building an economic individual with good organizing habits on the other hand.”

Many schools were opened that made education more popular than before. A World Bank research showed that “At the most prosperous period of French-invaded Indochina, Vietnam only had 2,322 elementary schools (for the first 3 years of primary education) with an average of one elementary school for every three villages, and the number of students accounted for 2% of total population; 638 primary schools (for the last years of primary education) with the number of students making up 0.4% of total population; 16 primary colleges (for 4 years of post-primary education) with students accounting for 0.05% of population; and 6 secondary schools of which 3 were public with only 0.019% of the population as state secondary students. The whole of French-colonized Indochina had only three universities (of Law, Medicine-Pharmacy and Sciences) located in Hanoi with 834 students, of which 628 were Vietnamese” [12].

In colonialism time, knowledge was almost transferred through education system, not by word of mouth like the previous stage. “Scholars agree that by the early twentieth century literacy rates in Vietnam had begun to increase, thanks to popularization and increasing availability of printed material in the Romanized Vietnamese language” [4].

##### **4.3. From State Formation to now**

With the establishment of the democratic republic, anti-illiteracy and improvement of people's learning

qualifications became the national policy. Learning how to read, write and calculate was perceived as a criterion for demonstrating a person's education.

During the 30 years of war between 1945 and 1975, Viet Nam's education system continued growing to meet the demand for national resistance and restructuring. A national education, that aimed to be imbued with national identity, to have a high scientific value and to be accessible to everyone, was formed and developed. In the late 1970s and early 1980s, Viet Nam faced serious economic difficulties, a lasting consequence of war, as well as the shortcomings in economic construction. To overcome the economic crisis, in 1986 Viet Nam implemented an innovative policy, moving from the centralized planning mechanism to a socialist-oriented market mechanism. Objective requirements were subsequently set forth to reform education [2].

The content and scope of the education reform focused on the following: adjust the ideas and solutions that were no longer suitable; boldly propose and implement solutions to stem the recession; stabilize the formation and consolidation of the system; create power and strength to continue developing in the direction of socialization, democratization, diversification, modernization, mobilization of all social sectors, families and schools in caring for the younger generation; make efforts to maintain, strengthen and further develop national education; care for the physical life and spirit of teachers and educational managers; and consider teachers and management staff to be the leading decisive factors in ensuring high quality and effective education [2].

## 5. Mass education in Vietnam.

### 5.1. Advantage

Alexander Woodside (1983) claimed that since Vietnam gained independence, starting from the philosophy "an illiterate nation is a powerless one", the Government issued, on 8 December 1945, important legal documents such as: Decree No. 17-SL: "Everyone in the country has to be literate"; Decree No. 19-SL: "For the entire country, there will be literacy classes established for farmers and workers to attend at night"; Decree No. 20-SL: "While waiting for the establishment of compulsory primary education, teaching the national language will be compulsory from now on and free for everyone"<sup>5</sup>. Then, on October 1945, President Ho Chi Minh issued the "Call for Anti-illiteracy" - That was the beginning of the mass education era in Vietnam [11].

What is "mass education era"? There is a definition by Yoshit Priya<sup>†</sup> that mass stands for 'on a big scale'. So mass education means you educate people on a vast scale. The advantage of mass education is there are more chance for people to access to education system. In Vietnam, according to the UNESCO's research, social equity in access to education has been improved, especially among ethnic minorities. Particular attention has been paid to increasing access to education for children from poor families, and for girls and marginalized children. During the period between 2001 and 2010, the net enrolment rates increased significantly. Enrolment of 5-year-old children in kindergarten increased from 72 per cent to 98 percent, primary education enrolment increased from 94 percent to 97 per cent, lower-secondary from 70 per cent to 85 per cent, and high school from 33 per cent to 50 per cent. Over the same period, training increased by a factor of 3.08, professional intermediate training increased by a factor of 2.69, and colleges and universities increased by a factor of 2.32. In addition, the trained employment rate reached 43 per cent. The network of education institutions across the country expanded, thereby increasing learning opportunities for everyone, supporting efforts towards achieving a learning society. The number of communes without ECCE was decreased; all communes gained primary and lower-secondary schools in communal or inter-communal areas; and high schools were established in the districts. The provinces and districts that have many people from ethnic minority groups were provided with boarding and semi-boarding schools [2].

### 5.2. Disadvantage

However, let professor Ken Robinson [6] tells the story of the failure of the "mass education" system in the world.

Why is education such a hot political issue? The first reason is economic. Educator has huge implications for economic prosperity. In the last twenty- five years, business has been transformed by the rapid development in digital technology and massive population growth. In the process, economic competition has intensified in trade, manufacturing, and services. Governments know that a well-educated workforce is crucial to national economic prosperity.

The second reason is cultural. Education is one of the main ways that communities pass on their value and traditions from one generation to the next. For some, education is a way of preserving a culture against outside influence; for others, it is a way of promoting cultural tolerance. It is partly because of its cultural significance that there is such political heat around the content of education.

The third reason is social. One of the declared aims of public education is to provide all students, whatever their backgrounds and circumstances, with opportunities to prosper and succeed and to become active and engaged citizens.

<sup>†</sup> B.TECH Civil Engineering, KIIT University



In practice, governments also want education to promote whatever attitudes and behaviors they think necessary for social stability. Those vary, of course, from one political system to another.

The fourth reason is personal. Most statements of public policy for education contain ritual passages about the need for all students to realize their potential and to live fulfilled and productive lives.

A high-performing education system is critical to national economic prosperity and to staying ahead of our competitors. Standards of academic achievement must be as high as possible, and schools must give priority to subjects and methods of teaching that promote these standards. Given the growth of the knowledge economy, it's essential that as many people as possible go on to higher education, especially four-year colleges and universities.

Because these matter are too important to be left to the discretion of schools, government needs to take control of education by setting the standards, specifying the content of the curriculum, testing students systematically to check that standards are being met, and making education more efficient through increased accountability and competition.

So what are the reformers doing to promote this agenda? There are three main strategies: standardization, competition, and corporatization.

### 5.2.1. Standardization

Formal education is made up of three main elements: curriculum, teaching, and assessment. The basic strategy is to standardize them as much as possible. Many countries now have firm guidelines for what schools should teach, usually year by year, in some sort of national curriculum.

Most national curriculums are based on the idea of discrete subjects. In most systems there is a hierarchy to these subjects. At the top are literacy, mathematics, and now the STEM disciplines (Science, technology, engineering, and math). Next come to the humanities, including history, geography, and social studies. Because the standards movement emphasizes academic study, it places less value on practical disciplines like art, drama, dance, music, design, and physical education and on "soft subjects" like communications and media studies, which are thought to be nonacademic. Within the arts, visual areas and music are usually given higher priority than drama and dance. Often these last two are taught at all. Vocational programs like shop and home economics have also disappeared from many schools. In some countries, provision for all of these "nonessential" disciplines has been devastated.

In term of teaching, the standards movement favors direct instruction of factual information and skills and whole-class teaching rather than group activities. It is skeptical about creativity, personal expression, and nonverbal, nonmathematical modes of work and of learning by discovery and imaginative play, even in preschool.

When it comes to assessment, the standards movement emphasizes formal, written examinations and extensive use of multiple-choice tests so that students' answers can be easily codified and processed. It is skeptical too of course work, portfolios, open-book tests, teacher evaluation, peer assessment, and other approaches that are not so easily quantifiable. This is partly why students spend so much time sitting at desks, working on their own.

### 5.2.2. Competition

One of the aims of testing is to increase competition between students, teachers and schools and on the assumption that it will drive up standards. In this new environment, students compete with each other, teachers are judged mainly on their students' test results, and schools and districts go head-to-head to win resources. Standards-based tests influence funding allocations, staff promotions, and whether or not schools stay open or are placed under different leadership.

### 5.2.3. *How it's going?*

The evidence is everywhere that the standards movement is largely failing by its own terms and creating more problems that it is solving.

In 2012, 17% of high school graduates in United States were unable to read or write fluently and had basic problems with spelling, grammar, and punctuation.

In term of elementary cultural knowledge, in 2006, National Geographic showed that 21% of young adults aged eighteen to twenty-four could not identify the Pacific Ocean on the map. Even more alarmingly, 65% could not identify the U.K on a map.

The standards movement is not meeting the economic challenges we face. Youth unemployment around the world is at record levels. There are about six hundred million people on Earth between the ages of fifteen and twenty-four. About seventy-three million of them are long-term unemployed [6]. Moreover, healthy economies depend on people having good ideas for new businesses and the ability to grow them and create employment. In 2008, IBM published a survey of what characteristics organization leaders need most in their staff. The two priorities were adaptability to change and creativity in generating new ideas. They found these qualities lacking in many highly qualified graduates. Moreover, Yong Zhao points out there is inverse relationship between countries that do well on standardized tests and those that demonstrate entrepreneurial flair.

The standards movement is not achieving the objectives it has set for itself. Meanwhile, it is having catastrophic

consequences on student engagement and teacher morale. In 1970, the United States had the highest rates of high school graduation in the world; now it has one of the lowest. Meanwhile, the teacher attrition rate is alarmingly high. In United States, more than a quarter of a million teachers leave the profession every year, and it is estimated that more than 40% of new teachers leave the profession within the first five years. The millions of students are bored and disaffected by the whole process. There are 63% students in North American, staying with the program reluctantly but have little interest in what they're doing and largely wait for the day to be over. The real costs of South Korea's high performance on international tests is the highest suicide rate of all industrialized OECD countries.

#### 5.2.4. So, what is wrong?

People do not come in standard sizes or shapes, now do their abilities and personalities. Understanding this basic truth is the key to seeing how the system is failing.

**Industrial structures:** Industrialism needed armies of manual workers for the repetitive and exhausting labor in the mines, factories, railways, and shipyards. It needed more-skilled technical workers in engineering and all the associated trades and crafts of mining, manufacturing and construction. It needed administrative workers to manage the new bureaucracies of trade and manufacturing. It needed a smaller professional class of lawyers, doctors, scientists and academics to provide expert services to those who could afford them.

**Industrial principles:** The purpose of industrial manufacturing is to produce identical version of the same products. Items that don't conform are thrown away or reprocessed. Systems of mass education were designed to mold students to certain requirement. But every individual is unique. We all differ physically and in our talents, personalities and interests. A narrow view of conformity inevitably creates enormous numbers of nonconformists who may be rejected by the system.

Industrial processes demand compliance with specific rules and standards. This principle is still applied to education. The standards movement is based on compliance in curriculum, teaching, and assessment. In a culture of compliance, students are not encouraged to ask questions, to look for alternative and unusual answers and to exercise their powers of creativity and imagination.

Industrial processes are linear. Raw materials are turned into products through sequential stages, each with some form of testing as a gateway to the next. Mass education was designed as a series of stages, from elementary school to high school to higher education. Students are typical organized into separate year groups and progress through the system in batches that are defined by date of birth. The principle of linearity works well for manufacturing; it doesn't for people because different students learn at different rates in different disciplines.

## 6. Trends of educational reform in the world.

A. Collins & R. Halverson (2010) claimed that: "We are now entering the lifelong learning era of education, having experienced the apprenticeship and schooling eras. These three eras differ in many aspects" [1]. The research showed clearly the shift of education from the agricultural to the industrial to the digital technology as below.

**Responsibility:** from parents to the state to the individual and parents. With the Industrial Revolution, the state took over responsibility for educating children from their parents. In the present era, responsibility for education is moving away from the state to the parents for younger children and the individual among teenagers and adults.

**Content:** From practical skills to basic skills and disciplinary knowledge to generic skills and learning to learn. The content of education before the Industrial Revolution focused on the skills and crafts of their parents and relatives, which children would need as adults. After the Industrial Revolution, schools stressed the learning of basic skills that children would need as adults. After the Industrial Revolution, schools stressed the learning of basic skills that children would need to function as intelligent citizens and workers and on the knowledge in the different disciplines. With the digital revolution, the focus is more on generic skills, such as problem solving and communication in different media, and on finding resource and learning from them.

**Pedagogy:** From apprenticeship to didacticism to interaction. The pedagogy of apprenticeship involves observation, coaching and practice. The adult shows how to do things and then watches while the learner tries, fading support as the learner gains experience. The pedagogy of school involves lecturing children, having them read texts and practice doing tasks, and testing to see if they have learned what was taught. The pedagogy of the current era is evolving towards reliance on interaction. Sometimes this involves interacting with a rich technological environment such as a computer tutor or a game on the web and sometimes with some other people by means of computer network.

**Assessment:** from observation to testing to embedded assessment. In the apprentice era, the master observed learners and corrected them as then went along, giving them tasks they were ready for and seeing if they completed them successfully. In the schooling era, testing emerged as the means to see if learners had acquired the skills and knowledge taught, before passing learner on to the next level. In the lifelong - learning era, assessment usually occurs as the learner progresses through a computer- learning environment in order to provide support to carry out the tasks and determine whether the learner has accomplished the goals. This looks more similar to the assessment in the apprenticeship era than the testing in school.

Location: centered in the home vs centered in the school and centered in multiple venues. In the apprenticeship era, most work was composed of household and domestic industries. Children usually learned to carry out adult tasks from parents or relatives. With the industrial revolution, children were gathered in schools to keep them off the streets and prepare them for industrial life. Schools are not very amenable to the customized education that is now sought, and so, education is moving into many different venues, such as homes, workplaces and learning centers, where learning materials can be accessed from computers and the web.

Culture: From adult culture to peer culture to mixed-age culture. Before the industrial revolution, children learned from the adults who were working around them. Peer culture arose with schooling and in many ways, adopted attitudes and beliefs that were opposed to learning. As learning moves out of a school setting, peer culture may weaken and there will be settings where children are working on tasks with their parents, other adults, peers and often in isolation from other people in a computer environment.

Relationships: from personal bonds to authority figure to computer-mediated interaction. In the apprenticeship era, children learned from adults that grew up around. With the advent of universal schooling they were learning from adults they did not know well and who did not understand their personal needs and abilities. As we move towards computer environment, learners will be interacting with the systems that are responsive to what they do but that have little understanding of them as individuals. However, at the same time, the systems will deal with them in a non-critical, impartial manner.

A general assessment of the educational model in Vietnam

Prof. Ken Robinson's arguments clearly explained UNESCO's assessment of Vietnam's education: "thinking about education has not been modernized. Strategic planning has not been fully recognized and human resource development has been insufficient at the national, ministerial and local levels. In society, the focus on examinations, degrees and achievements still dominates teaching and assessment" [10].

Comparing the status of educational development in Vietnam and the trend in the world shows that Vietnam is in the transition period between the industrial and technological era. In terms of responsibility, in the world the government is gradually redefining its role to individuals and families, in Vietnam, however in recent years there have been some significant shifts, learning almost depends on the national educational system. The content of teaching in Vietnam, especially in primary and tertiary education, mostly teaches students the knowledge of discipline. At higher education levels, such as masters or doctoral degrees, there are only a few schools for learning approaches or learning skills. In the light of learning method, we are deadlocked in didacticism, it means that lecturing children, having them read texts and practice doing tasks, and testing to see if they have learned what was taught. This way of education somewhat limits the creativity of the learner.

Jonathan D. London (2011) said that "Vietnam's education system is at a crossroads. Rapid economic growth over two decades has permitted unprecedented increases in the scale and scope of formal schooling. And yet there is a prevailing sense that Vietnam's current education system is inadequate to the country's needs" [4].

## **7. The fourth industrial revolution and Vietnam educational reform.**

### **7.1. What is the fourth industrial revolution?**

In Klaus Schwab's opinion [7], the first industrial revolution spanned from about 1760 to around 1840. Triggered by the construction of railroads and the invention of the steam engine, it ushered in mechanical production.

The second industrial revolution, which started in the late 19th century and into the early 20th century, made mass production possible, fostered by the advent of electricity and the assembly line.

The third industrial revolution began in the 1960s. It is usually called the computer or digital revolution because it was catalyzed by the development of semiconductors, mainframe computing (1960s), personal computing (1970s and 80s) and the internet (1990s).

The fourth industrial revolution is characterized by a much more ubiquitous and mobile internet, by smaller and more powerful sensors that have become cheaper, and by artificial intelligence and machine learning. The fourth industrial revolution is not only about smart and connected machines and systems, it also is the fusion of these technologies and their interaction across the physical, digital and biological domains. In this revolution, emerging technologies and broad-based innovation are diffusing much faster and more widely than in previous one, which continue to unfold in some parts of the world.

### **7.2. How the fourth industrial revolution impacts on Vietnam education.**

At the national level, "my view is that the competitiveness rules of the fourth industrial revolution economy are different from previous periods. To remain competitive, both companies and countries must be at the frontier of innovation in all its forms" [7]. For developing countries such as Vietnam, the story is getting tougher. "The fourth industrial revolution leads to significant "re-shoring" of global manufacturing to advanced economies, something very possible if access to low-cost labor no longer drives the competitive of firms. The ability to develop strong

manufacturing sectors serving the global economy based on cost advantages if a well-worn development pathway, allowing countries to accumulate capital, transfer technology and raise incomes. If this pathway closes, many countries will have to rethink their models and strategies of industrialization” [7]. Therefore, the skilled workforce is the critical factor to innovation, competitiveness and growth.

Moreover, when innovation is the most vital factor for economy to survive, the author of “The fourth industrial revolution” predicted that there are “many new positions and professions will emerge, driven not only by the fourth industrial revolution, but also by non-technological factors such as demographic pressures, geopolitical shifts and new social and cultural norms”. He also emphasized that “Given the increasing rate of change of technologies, the fourth industrial revolution will demand and place more emphasis on the ability of workers to adapt continuously and learn new skills and approaches within a variety of contexts.” So, “the aims of education are to enable students to understand the world around them and the talents within them so that they can become fulfilled individuals and active, compassionate citizens.”[6].

Vietnam Competitiveness Report (2010) showed that “Vietnam’s growth has been driven by market opening that has enabled it to realize its existing comparative advantages, primarily the abundance of low cost labor. The competitiveness fundamentals are broadly in line with the growing but still relatively low level of prosperity reached so far.” (p. 14) [2]. It is clear that the fourth industrial revolution is threatening the Vietnam economic growth in the long run and educational reform is the root for the sustainable development in Vietnam. In other words, the fourth industrial revolution will play the role of the external force driving the Vietnam educational reform.

## 8. Conclusion

This research showed that Vietnam education recently have poor performance and do not catch up with the education trend in the world. Moreover, the fourth industrial revolution will be motivation as well as pressure to promote the process more strongly and comprehensively. Based on the analytical framework of Tushman and Romanelli on the organizational behavior, it can be seen that in the future, Vietnam education will have a revolution.

## References

- [1] A. Collins & R. Halverson (2010) The second educational revolution: rethinking education in the age of technology, *Journal of Computer Assisted Learning* (2010), 26, p 18-27, Blackwell Publishing Ltd.
- [2] *Economica Viet Nam* (2011), Vietnam competitiveness report 2010. <http://www.economica.vn/Portals/0/Documents/Vietnam%20Competitiveness%20Report%202010Eng.pdf>
- [3] Tran Thi Phuong Hoa (2009), Franco - Vietnamese schools and the transition from Confucian to new kind of intellectual in colonial context of Tonkin, Havard - Yenching institute working paper series.
- [4] London, Jonathan D (2011), Education in Vietnam: Historical roots, recent trends, in *Education in Vietnam*, Institute of Southeast Asian Studies.
- [5] Murphy, Joseph and Mayborn, Frank W (2013), *Schooling in the Post-Industrial World: The North Star for Leadership*.  
[https://peabody.vanderbilt.edu/docs/pdf/lpo/schooling\\_post\\_industrial\\_murphy.pdf](https://peabody.vanderbilt.edu/docs/pdf/lpo/schooling_post_industrial_murphy.pdf)
- [6] Robinson, Ken and Aronica, Lou (2015), *Creative schools – The grass roots revolution that’s transforming education*, first published by Viking Penguin, a member of Penguin Group (USA).
- [7] Schwab, Klaus (2016), *The fourth industrial revolution*, the World Economic Forum.
- [8] Tuomi, Ilkka and Miller, Riel (2011), *The Learning teacher network*.
- [9] Tushman and Romanelli (1985), *Organizational Evolution: A Metamorphosis Model of Convergence and Reorientation*
- [10] UNESCO (2015), *The National Education For All 2015 review report: Viet Nam*  
[https://peabody.vanderbilt.edu/docs/pdf/lpo/schooling\\_post\\_industrial\\_murphy.pdf](https://peabody.vanderbilt.edu/docs/pdf/lpo/schooling_post_industrial_murphy.pdf)
- [11] Woodside, Alexander (1983), *The Triumphs and Failures of Mass Education in Vietnam*
- [12] World Bank (2015), *Education in Vietnam development history, challenges and solutions*.  
[http://siteresources.worldbank.org/EDUCATION/Resources/2782001121703274255/1439264-1153425508901/Education\\_Vietnam\\_Development.pdf](http://siteresources.worldbank.org/EDUCATION/Resources/2782001121703274255/1439264-1153425508901/Education_Vietnam_Development.pdf)

# Factors Influencing Mobile Banking Adoption in Ho Chi Minh City Based on The Technology Acceptance Model

Nguyen Dang Hai Yen

Master of Banking and Finance, Faculty of Finance, Banking University of Ho Chi Minh City, Viet Nam Country

---

---

## ABSTRACT

With the rapid development of technology, the change in demography and human lifestyle, the traditional bank industry is giving way to electrical bank (online banking) and the recent update – mobile banking (m-banking). However, statistics showed that the technology acceptance percentage is still very low. The lacks of recognition, the concern about security and technical issues are the reasons for the disapproval of clients to m-banking. Therefore, providers must understand and solve clients' need to maximize the m-banking experience. The present research is to show the using scales of m-banking clients and determine the influential factors on using m-banking. Data are obtained by using self-administrated questionnaire and analyzed with use of SPSS V.20. Out of the 600 questionnaires, only 450 useable questionnaires were returned. Results were subsequently analyzed by using multiple regression and correlation analysis. Factors such as Trust in mobile banking (TM), Social Influences (SI), Perceived Risk (PR), Perceived Compatibility (PC), Perceived Usefulness (PU) were found positively related with the intention to adopt mobile banking services. In which risk perception is a negative influence on the intention to use the service. From the results, some requests were given to raise the Mobile Banking approach ability for clients in Ho Chi Minh City, and from that advance the activity of commercial banks.

**Keywords:** Mobile Banking services, The 4.0 Industrial Revolution, Technology Acceptance Model (TAM), Adoption of mobile banking, Compatibility, Trust

---

---

## 1. Introduction

The world is stepping to the fourth industrial revolution – the era in which technologies such as visual reality, internet of things, 3D Printer, enormous data, and artificial intelligence apply in every aspect of life, economy, and society. This revolution is a big trend that has an impact on every country's economic – social development, every area and global, and there is Vietnam. The Fourth Industrial Revolution – FIR is formed on the foundation of the third revolution – the digital revolution, using electrical devices, information technology to automate the production process – (Larry Hatheway, 2016). Even though not being in nine areas/field influenced the most by the 4.0 industrial revolution, commerce banking – the area is seen in the top applying information technology and definitely in the range of the 4.0 industrial revolution. In the past ten years or so, the appearance of smart phones has changed completely the way people communicate and interact, results in the change in the distribution channel, selling network and product design of banks. Business experts think that electrical media can make the customer's approach method more efficiency than ever. It also saves a big amount of expense and eliminates the limitation of time and place. With this technology, they can provide products, services, sell or buy them to clients. Moreover, one of the new features using electrical technology services is providing banking and commerce service through internet and cell phones. Mobile banking created in 2010. Up till now, there are 32 banks that have developed this service; about 14-15 million transactions occurred monthly, the total value is up to thousands of billions every month. In the next 2-3 year, most of the banks are predicted to provide Mobile Banking service to clients. The service coverage in Vietnam will reach 20% population (Banknet.vn, 2014). Mobile banking service brings the highest customer care quality such as quick and safe transaction; clients can use it anytime that they need and at everywhere which has mobile signal or Wi-Fi network. Catching the market trend and the importance of Mobile Banking application in future, banks need to know clients' expectation from the Mobile Banking services, as well as their behaviours, factors affecting the acceptance of Mobile Banking to link more tightly with clients. This research focuses on exploring the different aspect of the factors of accepting Mobile Banking at ten Commercial banks in Ho Chi Minh City. The research points out the factors that influence the ability to

use Mobile Banking in Ho Chi Minh City. And from that comes some solution to assist banks into contemplating when building an online payment system.

## 2. Literature Review

WellFargo is the first bank to provide online banking in the U.S.A in 1989. Since then there have been many diggings, trials, successes as well as failures on the road building a perfect online banking, catering the best service for clients. Online banking services and products include: Call centre, Phone banking, Mobile banking, Home banking and Internet banking.

Therein, Mobile Banking is a modern banking service that allows clients use cell phones to perform transactions with the bank. It's an online payment method through cell phones (clients don't need to come to the bank and still be able to access to every service 24/7 in everywhere). This method was established to resolve the need to pay for small transactions or automated services without a server. Mobile banking is an application of m-commerce which enables customers to access bank accounts through mobile devices to conduct and complete bank-related transactions such as checking balance, checking account statuses, transferring money and selling stocks (Kim et al, 2009; Tiwari and Buse, 2007). Luo et al (2010), defined mobile banking as an innovative method for accessing banking services via a channel whereby the customer interacts with a bank using a mobile device. Now, there are many different models used to explain adoption of a new technology. One of the models has been widely used by various scholars for explaining technology adoption intentions is the Technology Acceptance Model (TAM) (Davies, 1989). Davis (1989) defines perceived ease of use as "the degree to which a person believes that using a particular system would be free from effort" and perceived usefulness as "the degree to which a person believes that using a particular system would enhance his or her job performance". In view of the different constructs being used, this paper extends the TAM by including Trust in mobile banking, Social Influences, Perceived Risk, Perceived Compatibility, Perceived Usefulness in which these constructs are believed to affect the behavioural intention to adopt mobile banking services.

### A. Trust in mobile banking.

Customer trust is considered to be an important factor for the success and growth of mobile banking. In a study by Kim et al. (2009) shown that whether or not the use of the technology depends on the first on the credibility of the customer and trust was defined as a psychological expectation that a trusted party will not behave opportunistically.

### B. Social Influence

The level of social influence affects the adoption of a new technology. Research by H. Amin et al. (2007) shows that the impact of community as well as the impact of family members (S.Sing et al. 2010) intend to adoption their technology. Along with the group idea, study (C.-S. Yu, 2012), explaining entrepreneurs' Behavioural Intention to use computerized accounting system by social influences. This shows that for individuals with less information and experience in new technology services, social influence becomes very important (S. S. Nawaz và A.M. Sheham, 2015)

### C. Perceived Compatibility

Compatibility is an important aspect that affects the psychology of service users that can be defined as the extent of relevance of the service to the present value of the user such as beliefs, habits, how to do it, previous experiences (Chen et al, 2008). Rogers (1995) and studies (Agarwal and Karahanna, 1998; Wu and Wang, 2005) show that compatibility will lead to higher perceived ease of use as less effort is required

### D. Perceived Risk (PR)

Perceived risk can be interpreted as uncertainty about the outcome and safety of using a new service (Gerrard and Cunningham, 2003). In a study by Luo et al. (2010) shows that adopt to new technology is limited when users perceive that the use of new technology is at higher risk than using traditional technology. The findings show that perceived risk has negative significant relationship towards behavioral intention on mobile banking adoption

### E. Perceived Usefulness (PU)

Perceived usefulness is measured by the degree to which new technologies are delivering to customers (Davis, 1989). That is, one will compare the effectiveness between before and after applying new technology in terms of time, cost ... (Chan, 2004). Actually, a new system is not as effective as expected, it will not be widely accepted and used. (Venkatesh et al., 2003). Therefore, Perceived usefulness is recognized as having a strong positive impact on the intent of the adopter to use the innovation.

## 3. Research's model and hypothesis

This study has postulated to test the following hypotheses which have been developed from the review of literature.

H1: Trust in Mobile Banking service will be proportional to the accessibility of clients. As the Mobile Banking service's credibility increase, the accessibility will also increase.

H2: Social Influences will be proportional to the accessibility of clients. As the Mobile Banking service's interaction increase, the accessibility will also increase.

H3: Perceived Risk of Mobile Banking service will be proportional to the accessibility of clients. As the Mobile

Banking service's risk increase, the accessibility will also decrease.

H4: Perceived Compatibility of Mobile Banking service will be proportional to the accessibility of clients. As the Mobile Banking service's compatibility increase, the accessibility will also increase.

H5: The Perceived Usefulness of Mobile Banking service will be proportional to the accessibility of clients. As the Mobile Banking service's usefulness increase, the accessibility will also increase.

#### 4. Research Methodology

In this section, we discuss the sampling and data collection procedures followed by variables operational measurement and statistical tests used to evaluate hypotheses.

The sample selected by the convenient sampling method. According to Hair & ctg (1998), to be able to analyze the discovery factor (EFA), it was necessary to collect data sets with at least 5 samples per observation variable. In addition, to conduct regression analysis in the best way, Tabachnick & Fidell (1996) suggested that the sample size must be guaranteed by the formula:  $n > 8m + 50$ . Therein:  $n$  is the sample size and  $m$  is the independent variable of the model.

Thus, the model of five independent factors with 25 observable variables should have a sample size greater than 90. To ensure the sample representation of the survey, 600 questionnaires were sent to the interview and collected 480 questionnaires. There were 30 invalid questionnaires due to lack of information in the 480 questionnaires that were collected. As a result, there were 450 valid questionnaires used as data for the study.

To have a solution for developing Mobile Banking services for clients in the East of Ho Chi Minh City, the author uses this model of Davis (1989) to analyse user behaviour, especially in applications of different types of information systems. This model is, in fact, a combination of factors affecting the adoption of technology.

Applying the TAM model into practice in Vietnam, the elements used to assess the clients' adoption of technology consist of 5 independent Variables and one of dependent variables.

The regression equation is written as below:

$$BI = \beta_0 + \beta_1X_1 + \beta_2X_2 + \beta_3X_3 + \beta_4X_4 + \beta_5X_5 + E_i. \text{ Such as:}$$

Dependent variable BI: Behavioural intention

Independent variables includes: X1: Variable Trust in mobile banking (TM); X2: Variable Social Influences (SI); X3: Variable Perceived Risk (PR); X4: Variable Perceived Compatibility; X5: Variable Perceived Usefulness;  $\beta_0, \beta_1, \beta_2, \beta_3, \beta_4, \beta_5$ : regression coefficients;

$E_i$ : remainders

#### 5. Data Analysis

##### 5.1. Description sample

Sample from surveyed respondents is shown in Table 1.

**Table 1: Demographic Profile of Respondents**

Demographic Variables	Groups	Frequency	Percentage (%)
Gender	Male	194	43.1
	Female	256	56.9
Age (in years)	18-25	124	27.6
	26-35	150	33.3
	36-45	144	32.0
	45 and above	32	7.1
Academic Qualification	Bachelor's Degree	181	40.2
	Master's Degree	115	25,6
	Ph. D	95	21.1
	No College Degree	59	13.1
Adopted Device	Smart Phone	213	47.33
	3G Mobile Phone	175	38.89
	Basic Phone	89	13.78

Mobile Banking Usage Frequency	More than 5 transactions per month.	157	34.89
	Maximum up to 5 transactions per month	293	65.11

Source: Author's synthesis.

Sample survey is distributed by gender is 43.1 percent for males and 56.9 percent for females, with the age group 26-35 with 33.3 percent. Majority of respondents have bachelor's degree qualification with 40.2 percent, Master's degree with 25.6 percent and rest 13.1 percent do not have a college degree. The data also show that in the survey sample, the proportion of smart phone users accounted for a high proportion, with 47.33 percent. However, the frequency of mobile phone transactions is not high, with 65.11% of customers using up to five transactions within a month.

**Table 2: Encoding the scale for components**

No.	Encryption	Description
	TRUST IN MOBILE BANKING (TM)	
	TM1	Provides the service like commitment
:	TM2	Do not disclose personal information
:	TM3	Secure in every transaction
:	TM4	Exactly in take notes
	SOCIAL INFLUENCES (SI)	
	SI1	There are support forums
:	SI2	There is a large community in use.
:	SI3	Network of acquaintances to use.
:	SI4	Quick registration procedures
:	SI5	Interface is intuitive, easy to customize as desired
	PERCEIVED RISK (PR)	
	RR1	Password integrity
:	RR2	Privacy
:	RR3	Data encryption
:	RR4	Hacking
:	RR5	The protection of personal information
	PERCEIVED COMPATIBILITY (PC)	
	PC1	Consistent with the user's lifestyle
:	PC2	Compatible with most banking operations
:	PC3	Compatible with the user's situation
:	PC4	Compatible with user-requested functions.
:	PC5	Have convenient transaction time with customers
	PERCEIVED USEFULNESS (PU)	
	PU1	Mobile banking service has many benefits.
:	PU2	Improve your way to work with bank: fast, convenient.
:	PU3	Variety of services and more convenient.
:	PU4	Advanced technology and high security, and can be used everywhere
	BEHAVIORAL INTENTION TO ADOPT MOBILE BANKING (BI)	
	BI1	Overall, Mobile banking meets my aspirations
:	BI2	I am completely satisfied with the mobile banking services
:	BI3	In the future I will use Mobile banking service
:	BI4	I will introduce mobile banking service to others

Source: Author's synthesis.

## 5.2. Cronbach Alpha confidence factor Analysis

**Table 3: Results of Multiple Scale Analysis**

Scale Mean if Item Deleted	Scale Variance if Item Deleted	Corrected Item-Total Correlation	Cronbach's Alpha if Item Deleted
----------------------------	--------------------------------	----------------------------------	----------------------------------



Prestige of banks (TM) Alpha: .658				
TM1	11.98	3.307	.509	.543
TM2	12.01	3.474	.459	.578
TM3	11.75	3.622	.434	.595
TM4	11.92	3.214	.374	.649
Social Influences (SI) Alpha: .758 (Run the second time after removing SI1 variable and have coefficient of correlation variable total <0.3)				
SI2	11.35	3.958	.548	.706
SI3	11.37	3.842	.577	.690
SI4	11.43	3.792	.507	.730
SI5	11.34	3.588	.595	.679
Perceived Risk (PR) Alpha: .754 (Run the second time after removing PR4 variable and have coefficient of correlation variable total <0.3)				
PR1	11.36	3.932	.545	.701
PR2	11.38	3.827	.571	.687
PR3	11.44	3.762	.503	.726
PR5	11.35	3.581	.590	.675
Perceived compatibility (PC) Alpha: .728				
PC1	13.90	5.642	.542	.661
PC2	14.11	5.677	.603	.643
PC3	14.84	5.850	.393	.722
PC4	14.23	5.659	.453	.779
PC5	13.93	5.822	.479	.685
Perceived Usefulness (PU) Alpha: .757				
PU1	11.46	3.629	.565	.694
PU2	11.57	3.225	.604	.673
PU3	11.69	3.866	.573	.695
PU4	11.62	3.760	.490	.735
The behavioral Intention to adopt Mobile banking (BI) Alpha: .818				
BI1	11.62	3.769	.658	.765
BI2	11.74	3.589	.656	.763
BI3	11.39	3.767	.616	.781
BI4	11.56	3.263	.640	.775

Source: Author's synthesis.

Thus, after testing Cronbach's Alpha and comparing the coefficients of the variables total of the variables to the Cronbach's Alpha confidence of variables are a value of 0.6, the results show that a SI1, PR4 observation variable needs to be removed before include the EFA discovery factor analysis.

### 5.3. The EFA discovery factor.

After checking the reliability of the scale, exploratory factor analysis was conducted. The extraction method chosen for factor analysis is the principal components method with varimax rotation. Discovery factor analysis in the second time with model after removal of three PC3, TM4, SI3. KMO and Bartlett's tests in the factor analysis showed that the high KMO variables ( $0.877 > 0.5$ ), Bartlett's test value was significant (Sig. = 0.000 < 0.05) indicating that the EFA factor analysis was appropriate.

The Intention to adopt Mobile banking scale is measured by four observation variables. After testing reliability with Cronbach's Alpha, these four variables ensure reliability. The EFA Discovery Factor Analysis is used to re-evaluate the convergence of observable variables by components.

Testing KMO and Bartlett's in factor satisfaction analysis showed that the KMO coefficient was satisfactory (= 0.803 Bartlett's test value and significance level (Sig. = 0.000 < 0.05)) showed that the EFA factor analysis was appropriate.

**Table 4. Summary of factors after KMO and Bartlett's Test**

No.	Factor	Observation variables	Type
1	Trust in mobile banking	TM1, TM2, TM3 (3 variables)	Independent
2	Social Influences	SI2, SI4, SI5 (3 variables)	Independent
3	Perceived risk	PR1, PR2, PR3, PR5 (4 variables)	Independent
4	Perceived Compatibility	PC1, PC2, PC4, PC5 (4 variables)	Independent

5	Perceived Usefulness	PU1,PU2, PU3, PU4 (4 variables)	Independent
6	The Behavioral intention to adopt Mobile banking	BI1, BI2, BI3, BI4 (4 variables)	Dependent

Source: Author's synthesis.

#### 5.4. Correlation Analysis

The purpose of Pearson correlation analysis is to examine the relationships among variables. Table 4 represents correlation coefficients among dependent variable and independent variables. The highest correlation shown in the table is 0.657 (< 0.8). Hence, there is no multi co linearity problem in this study.

**Table 5: Correlation Analysis of the Independent Variables**

Variables	Trust in the mobile banking	Social Influences	Perceived risk	Perceived Compatibility	Perceived Usefulness
Trust in the mobile banking (TM)	1	0.411	0.322	- 0.460	0.498
Social Influences (SI)	0.411	1	0.600	- 0.589	0.497
Perceived Risk (PR)	0.322	0.600	1	- 0.515	0.355
Perceived Compatibility (PC)	- 0.460	- 0.589	- 0.515	1	0.657
Perceived Usefulness (PU)	0.498	0.497	0.335	0.657	1

Source: Author's synthesis.

#### 5.5. Multiple Regression Analysis

After testing the scales by EFA, Cronbach's Alpha we have identified five factors that affect the ability to use mobile banking services of the bank's research group. They are: Prestige of banks, **Social Influences**, **Perceived Compatibility**, **Perceived Risk**, **Perceived Usefulness**. As a result of running regression model, the variables have a Sig coefficient of less than 0.05, so that these independent variables are meaningful explanation for the dependent variable, none of them is excluded from the model. The VIF coefficients of independent variables <10 therefore there is not occur with multi- collinearity. The regression coefficients are all greater than 0. So all the independent variables included in the regression model analysis are work in the same direction on the dependent variable.

**Table 6: Results of Multiple Regression Analysis**

Model	Standardized Coefficients ( $\beta$ )	t value	Significance
Constant	-.006	-.038	0.969
Trust in mobile banking (TM)	0.183	5.119	0.000
Social influences (SI)	0.096	2.272	0.024
Perceived Risk (PR)	-0.187	-4.846	0.000
Perceived Compatibility (PR)	.234	5.217	0.000
Perceived Usefulness (PU)	0.303	7.258	0.000
R2	0.608		

Adjusted R <sup>2</sup>	0.604
Significant F	0.000

Source: Author's synthesis.

So, with 5 hypotheses from H1 to H5 which authors have set out above hypotheses, all of the five hypothesis are accepted corresponding variables: Prestige of banks, Social Influences, Perceived Compatibility, Perceived Risk, Perceived Usefulness. Standardized regression equation:

$$BI = 0.303*PU + 0.234*PC - 0.187*PR + 0.183*PB + 0.096*SI$$

## 6. Discussion and Summary of Findings

According to experts, Vietnam is a very potential market for Mobile Banking. However, the growth rate between mobile users and mobile banking users in Vietnam is not adequate. It can be said that this is a very rich market and not thoroughly explored by banks. Ho Chi Minh City is the centre of exciting economic and political activities of the country, the population here is very crowded. Therefore, the study of key factors affecting the ability to use mobile banking services of clients in Ho Chi Minh City is very necessary. In this study, the factors affecting the use of customer's mobile banking service are five factors. Research results show that all 5 factors have significant effect on whether or not individuals accept the use of mobile banking services, namely:

The factor of Perceived Usefulness ( $\beta = 0.303$ ) perceives the customer in relation to the potential advantage for their decision. This factor is used in many studies involving the application of new technologies. Moreover, the usefulness factor has a direct and strong impact on the intention to use mobile banking, in line with the findings of Drennan and Wessels (2010). As mentioned, Mobile banking brings great benefits and convenience to customers. Therefore, banks should pay attention to the value of experience and increase utility for customers.

The next factor is Perceived compatibility with lifestyle ( $\beta = 0.234$ ). In the Koenig-Lewis study, compatibility has a strong positive effect on consumer intent toward adoption of mobile banking. However, in the Wessels and Drennan study of the year (2010) compatibility was the second strongest factor influencing the intention to use Mobile-banking, the results of other studies also show the importance of compatibility with the customer's life. So banks need to research to offer services, as well as create the right software to integrate deeply into the lives of their clients.

The third factor is Perceived risk ( $\beta = -0.187$ ). This is a matter of top concern. When the risks occur, what is the bank's responsibility and what will they do to overcome it? Risks in transactions are one of the factors mentioned so much in research. Whether a person decides to use mobile banking or not is due to this factor in part, they are worried that hackers will be attacked. And another factor is that they fear of dealing with a mobile device will not be as secure as fixed devices. The bank must take measure to resolve the situation. The author's findings are consistent with those of previous authors such as: Luo et al. (2010); Mitchell (1999), Laforet and Li, (2005); Luarn and Lin, (2005); and Gu, et al., (2009). Therefore, banks and service providers should continuously innovate and offer better security and reliable applications to enhance users' confidence towards adoption and continuous usage of mobile banking services.

The fourth factor is Trust in the mobile banking ( $\beta = 0.183$ ). This result is consistent with previous studies such as the Luarn and Lin (2005) study, which finds credibility that significantly influences mobile-banking adoption. Customer perception from transactional security and the sending and receiving of information affects their use and trust on mobile banking. Therefore, banks need to improve and enhance the security of their mobile banking. From that point it may be necessary to further enhance security to meet the needs of our customers.

Finally, the Social Influences factor ( $\beta = 0.096$ ) also plays an important role. This result is consistent with previous studies such as V.Venkatesh, etc, (2003) study, which finds credibility that significantly influences mobile-banking adoption. Therefore, banks should encourage people to use this service by providing information about its use and using incentive policies, procedures are neatly reduced and have quick and timely support staff. In addition to encouraging banks, it is advisable to provide referrals and advertisements to make it known to the public and clients.

## 7. Conclusion and Recommendation

In summary, the results of the study show that perceived usefulness, perceived ease of use, relative advantages, perceived risks and personal innovativeness were the factors affecting the behavioral intention of mobile users in this city. In particular, awareness of risk is the only factor that has a negative impact on the application of this service. The value of research has provided valuable knowledge and information to banks, service developers, and software engineers to enhance consumers' intention to use mobile banking services in future. After reviewing the findings of this study, there are several important implications recommended for banks, service developers and software engineers in order to provide better strategic insight to design and implement mobile banking services that yield higher consumer acceptance in Ho Chi Minh City, such as:

First, it is necessary to increase the availability of mobile payment connectivity among three banking units, telecommunications companies and service providers in a systematic way.

Second, the registration of Mobile Banking services is mainly carried out at transaction offices and branches of banks so it is not convenient for customers to sign up for special services for remote clients who wish to register for services in a short time. Therefore, banks need to expand their cooperation with various service providers to deploy payment on Mobile Banking and Mobile Payment and allow clients to subscribe to Mobile Banking on electronic channels such as the Internet. Banking, Phone Banking, Digital Branches ... or at shops that have cooperation with banks.

Third, to increase the security of Mobile Banking, during the transaction: messages need to be encrypted in combination with the use of other security measures such as entering PIN identifiers or one time password (OTP). In addition, other security measures such as password matrix (Matrix- Password) can be used.

Finally, to increase confidence in transactions via Mobile Banking, banks need to upgrade their technology systems, automatically handle transaction errors, and improve customer support through contact centre system.

## References

- [1] Agarwal, R. and Karahanna, E, (1998), "On the multi-dimensional nature of compatibility beliefs in technology acceptance, digit, available at: <http://disc-nt.cba.uh.edu/chin/digit98/first>.
- [2] H. Amin, R. Baba, and M.Z. Muhammad, "An analysis of mobile banking acceptance by Malaysian customers," Sunway University College Academic Journal , pp. 1-12, 2007.
- [3] C.-S. Yu, (2012), "Factors affecting individuals to adopt mobile banking: empirical evidence from the UTAUT Model."
- [4] Chan S. C., Lu M. T.(2004)"Understanding internet banking adoption and use behavior: A Hong Kong perspective", Journal of Global Information Management, Vol. 12, No. 3, pp. 21-43.
- [5] Chen, L.D. (2008), "A model of consumer acceptance of mobile payment", International Journal of Mobile Communications, 6 (1), pp. 32-52.
- [6] Davis F. D, (1989), "Perceived usefulness, perceived ease of use, and user acceptance of information technology", MIS Quarterly, Vol. 13, No. 3, pp. 319-340.
- [7] Gerrard, P. and, Cunningham, J. (2003), "The diffusion of internet banking among Singapore consumers", International Journal of Bank Marketing, 21(1), pp. 16-28.
- [8] Gu J. C., Lee S. C., Suh Y. H.,(2009), "Determinants of behavioral intention to mobile banking", Expert Systems with Applications, Vol. 36, No. 9, pp. 11605-11616.
- [9] Kim, G., Shin, B. and Lee, H.G. (2009), "Understanding dynamics between initial trust and usage intentions of mobile banking", Information Systems Journal, 19 (3), pp. 283-311.
- [10] Laforet, S. and Li, X.(2005), "Consumers' attitudes towards online and mobile banking in China ", International Journal of Bank Marketing, 23(5), pp. 362-380.
- [11] Larry Hatheway (2016), Mastering the Fourth Industrial Revolution, Project Syndicate.
- [12] Luarn, P. and, Lin, H. H.(2005), " Toward an understanding of the behavioral intention to use mobile banking ", Computers in Human Behavior, 21( 6), pp. 873-891.
- [13] Luo, X., Li, H., Zhang, J., & Shim, J. P. (2010), "Examining multi-dimensional trust and multifaceted risk in initial acceptance of emerging technologies: An empirical study of mobile banking services". Decision Support Systems, 49(2), pp. 222-234.
- [14] Mitchell, V. W.(1999), "Consumer perceived risk: Conceptualizations and models", European Journal of Marketing, 33(1/2), pp. 163-195.
- [15] S.S. Nawaz and A.M. Sheham, (2015), "Evaluating the Intention to use Accounting Information Systems," Research Journal of Finance and Accounting, pp. ISSN 2222-1697 (Paper) ISSN 2222-2847.
- [16] Siau, K., & Shen, Z. (2003), "Building customer trust in mobile commerce", Communications of the ACM, 46(4), pp.91-94.
- [17] S. Singh, V. Srivastava and R.K. Srivastava (2010) " Customer acceptance of mobile banking: A conceptual framework," SIES Journal of Managementen , pp. 55-64.
- [18] Tiwari, R. and Buse, S. (2007). The Mobile Commerce Prospects: A Strategic Analysis of opportunities in the Banking Sector. Hamburg: Hamburg University Press.
- [19] Venkatesh, V., Morris, M. G., Davis, G. B. & Davis, F. D. (2003), "User acceptance of information technology: Toward a unified view", MIS Quarterly, 27(3), pp.425-478.
- [20] Wessels, L., Drennan, J., (2010), "An investigation of consumer acceptance of M-banking", International Journal of Bank Marketing 28 (7), pp. 547-568.
- [21] Wu, J., and Wang, S. (2005), "What drives mobile commerce?: An empirical evaluation of the revised technology acceptance model", Information & Management, 42(5), pp.719-729.

International Conference For Young Researchers In Economics And Business, ICYREB 2017, October 30<sup>th</sup> 2017  
Da Nang, Vietnam

## Brand Image of Retailer in Electronic Consumer: The Study of Pico and Mobile World

NGUYEN Thu Huong\*, DAO Cao Son\*, LE Thi Duyen\*

NGUYEN Thu Huong, Brand Management Department, Marketing Faculty, Thuongmai University

DAO Cao Son, Brand Management Department, Marketing Faculty, Thuongmai University

LE Thi Duyen, Brand Management Department, Marketing Faculty, Thuongmai University

### ABSTRACT

The purpose of this study is to demonstrate the overall brand image of retailer in electronic consumer sector, typically in the electronics consumer sector such as Pico and Mobile World. From that, there are several suggestions for retailers based on customer's review. Secondary data from external publications and primary data from survey method with structured questionnaire collected as well as analyzed with reference from well-known methodological theories. This research reveals that the need of improving accessibility, providing promotion programs creatively and training staff more effectively. Besides, price and product assortments should be suited for customer's requirements. These results could be a compelling evidence for retailers to consider their brand management and business in general.

**Keywords:** brand image, retailer, electronic consumer

### 1. Introduction

Vietnam retail market has received a lot of attention from both domestic and foreign investors as its total volume exhibited a remarkable rise by 10.6% [GSO] and increased significantly in 2016, according to Deloitte and Statista. This comes from (1) the succession of signing trade agreements, for example, Viet Nam – Japan, Viet Nam – Korea, or ASEAN – Australia – New Zealand, etc.; (2) the rapid growth of a young population as well as an increasing amount of actual income of the middle class; and (3) In comparison with other countries in ASEAN, one of Viet Nam's competitive advantages is the improvement of business environment, with its politics and society being stable and safe.

The emergence of foreigners in retail sector has become increasingly popular with Vietnamese consumers. In recent years, many merge and acquisitions transactions in which Vietnamese firms have been taken over by their foreign counterparts means more pressure on domestic entrepreneurs.

Vietnamese retailers could hardly stand idly by and they need to react to the overwhelming appearance of big foreign retailers. They have made a number of efforts, including restructuring organizations, associating with a new supply chain, or applying modern business technology, and especially building a brand with a long – term vision.

The meaning of brand shows through the impact of brand image in customer's buying behavior when they prefer a branded product or service than unbranded ones. On the other hand, it is easier for famous service providers to not only triumph over the difficulties in approaching their potential customers, but also keep the loyalty of the current customers longer and closer. Therefore, brand building is a priority of service firms such as retailers in Viet Nam.

In previous studies, the retailer's brand is a topic that has received a lot of attention from a number of marketing and brand researchers, including Keller (2003), JN Kapferer (2008), Kotler (2012), Ailawadi (2004), Allaway (2011), Kumar (2007), Jesko & Dennis (2013), Sullivan & Adcock (2011), ...

\* NGUYEN Thu Huong. Tel.: +84 979 093 039  
E-mail address: huongnt.t@tmu.edu.vn

In general, all of the research recognizes the importance of brand in maintaining customer loyalty by positioning a brand image which is created by strong, unique and favourable brand associations in the minds of consumers. In details, Ailawadi (2004) brings to the synthesis from various studies related to the retailer’s brand image, and five aspects of the retailer brand image studied are: Access; In-door atmosphere; Price and promotion programs; Product Assortment; Brand category. All of them have been developed from several studies in the past and chosen by its effects on the overall brand image of retail businesses in the minds of end consumers.

Similarly, Sullivan & Adcock (2011) also argue that branding is more than a mere aggregation of parts of a retail marketing activity; that is, the customer receives a complete package from a retailer. Accordingly, the eight elements of retail marketing will constitute a package for the customer or the total product offerings: Location and Perceived Image (Physical/ Virtual location; Retail Image, position and reputation); Internal environment and core products (Internal atmosphere/ environment, range/assortment of goods offered); In-store stimuli (Relative price/value perception, promotional effectiveness, service levels, both during before and after sales); Relationship issues and building loyalty (Strength of any on – going relationships that might exists). On the other hand, the amalgam of the physical environment, current air, convenience, customer, existing goods, service and Other (can be tangible or can be felt only) have an impact on retailer image. To sum up, brand image is made up of all that is tangible and all the business endeavors to deliver to customers a consistent message throughout the process before, during and after sales.

While Sullivan and Adcock (2011) analyzes the brand from the perspective of retail marketing factors, Jesko & Dennis (2011) concentrates on a tool named “Retail Pentagon” that McKinsey has developed for retailer in brand management as a framework to highlight the five elements of a benchmark player: Price, Service, Convenience, Purchasing Experience, and Portfolio.

From here, authors use five aspects of the retailer image of Ailawadi KL & Keller, KL (2004) and add the dimension “Staff” as one of Retailer Image aspects; this comes from Kafperer (2008) with analysis of service brands, distributors 'brands, and retailers' brands. On the other hand, with the characteristic of electronic products and its business, sometimes, these add-on services have an important influence on the customer's choice. This is the warranty service, transportation service - installation, delivery service, repair service, etc. In conclusion, this research uses 7 dimensions: Access, Price, Promotion, Product – brand assortment, Staff, Services (Add-on services), In-door atmosphere as a component of retailer brand image.

The purpose of this study is to demonstrate the overall brand image of retailers in the electronic consumer sector and put forward some recommendations accordingly.

The scope of this research is within the city of Hanoi and two branded retailers are selected on the basis of (1) their history, (2) their size of business premises.

**Table 1. Branded retailers in electronic consumer in Hanoi**

Brand	Owner	Retail Type	Time established	Existing years (to 2017)	Total Point Sales	Point of Sales in Hanoi
Mobile World	Mobile World ., JSC	Department Store	Mar-2004	13	663	152
HC	VHC .,Limited Trading Company	Supermarket	2006	11	14	6
Viettel Store	Viettel	Department Store	2006	11	314	26
Pico	Pico .,JSC	Supermarket	Jul-2007	10	20	9
Tran Anh	Tran Anh World ., JSC	Digital Supermarket	Aug - 2007	10	28	9
FPT Shop	FPT	Department Store	Aug-2007	10	426	52
Media Mart	Media Mart .,JSC	Supermarket	2008	9	49	15
Vinpro	Vincommerce	Mall	Mar-2015	2	22	6

According to the preliminary results shown on the table, Mobile World was selected to represent Department Stores. HC is the perfect example of the supermarket category, but it is underrepresented in Hanoi compared to Pico and Tran Anh, so Pico was selected for their oriented business in Hanoi area.

To map the brand image of retailer, a survey was conducted via questionnaires in order to access and evaluate customer’s satisfaction based on their experience with retailers.

## 2. Methodology

The purpose of this chapter is to explain this study’s research approach, data collection method as well as the data analysis process with reference from well-known methodological theories.

This chapter introduces the methods used in the study. First, the survey instrument design and pre-test procedure are discussed. The explanation of the data collection procedures, and the description of the sample’s characteristics follows. Finally, the measurement validation process and the final scale items are presented.

### Research strategy

In this research, we decide to apply survey method by using a structured questionnaire. Using the questionnaire, the data is standardized to achieve better comprehensibility and comparability. However, it is time-consuming to design and pilot questionnaires, and then to analyze collected data to gain useable results for the research, even with the support of an appropriate computer package. Moreover, surveys can only cover a limited number of questions as well as a limited range of data compared to qualitative research methods. Another disadvantage is that if there is no control of validity, respondents might give unrealistic answers because they are unwilling to take part in the survey or they may be biased against the subject or content of the study. We are aware of all above drawbacks when taking questionnaire into our research. In the next section, we will describe the data collection and data analysis process.

### Data collection

#### Secondary data

In this research, we use the external published secondary data from articles, books, statistics, research reports and the Internet. In order to get a background understanding about the electronic consumer in Vietnam, online newspapers are used to derive data about the status of business. Besides, commerce industry analyses and research reports are studied to have an understanding on the whole commerce of Vietnam and particularly, the market of consumer electronics. Moreover, we also collect secondary data from the retailers’ official publications to compare their products, brands, prices, marketing and distribution channels.

#### Primary data

In this research, we mainly use primary data to answer the research questions. Primary data is used to get information about the retailer consumers purchased the most as well as their consumers’ responses on purchasing experiences. We collect primary data by using questionnaire.

### Questionnaire design

Questionnaire is the main tool of survey method we use to collect data for our research. To collect the information needed, we use all structured questions, namely close-ended questions. Using this structure, questions are asked and pre-determined answers are given as different options for respondents to choose the most suitable answer for them. The advantage of this kind is that it requires less interviewer skill, takes less time and is easier for the respondent to answer rather than unstructured questions that respondents need to answer in their own words. A structured question may be multiple-choice, dichotomy or a scale. We use all those kinds since to get demographic information of respondents,. The questions later are allocated in a logical order to avoid the missing information for researchers and confusing for respondents.

The questionnaire consists of four sections and each brand (Pico, Mobile World) has a specific form. Firstly, we asked respondents to name the electronic consumer retailer they have purchased the most. Four other questions regarding shopping behavior were also asked in this section. Next, respondents were asked to evaluate the retailer they had named previously in terms of brand image. To measure brand image, we chose 15 items that cover 7 dimensions of access, price, promotion, product – brand assortment, staff, services, in-door atmosphere. At the end of this section, we asked them to rate the total retail experience on the scale of one to ten. Thirdly, the respondents’ review of brand identity towards the retailer was asked. Lastly, demographic information was also collected.

**Table 2 - The initial set of items for the core constructs**

Dimension	Details	Item
Access	Store locations are convenient for transportation	Acc1
	Locations have an easy access points	Acc2
Price	The price of goods is suitable	Pr1
Promotion	There are attractive promotions	Promo1
	Frequently changing promotions	Promo2
Product – Brand assortment	There are a variety of goods	ProBrand1
	There are many different branded goods	ProBrand2
	There are many up-to-date goods	ProBrand3
	Quality of goods is well controlled	ProBrand4
Staff	There are dedicated staff	Staff1
	Staff have a suitable attitude and behaviour	Staff2
Services	Good transportation and installation services	Serv1

In-door atmosphere	Good warranty service An apt shopping spaces A comfortable space	Serv2 Atmos1 Atmos2
--------------------	--	---------------------------

**Questionnaire distribution**

We use text-based email and the Internet-based questionnaire to deliver the questionnaire to potential respondents. The questionnaire is finalized as presented in the Appendix.

As we use questionnaire to collect data, we need to determine the sample of population to be respondents involving into the survey. Our research aims at investigating consumers’ purchase experiences, especially who bought electronic products. Consumers in this context are people who have roles in decision-making and buying processes. We decide to select a subgroup from all the consumers who had purchased products at these retailers to examine since researching the whole group would require too much time and funding. The subgroup or the sample group used for our research includes inhabitants living in Hanoi – the capital of Vietnam. The sample includes people with relatively homogenous elements such as age, education, or career, etc. ...and importantly, they have a sufficient knowledge on shopping.

The sample size is determined with enough number to represent the whole target population of the research. To get sufficient data for analysis as well as to be able to achieve the objective, we expect to get 150 respondents. Initially we have distributed a total of 160 text-based email questionnaires and 30 Internet-based questionnaires. After the data collection process, we received 170 responses, 20 of which are excluded due to being incomplete. Finally, 170 usable data were used for data analysis in IBM SPSS 20. As can be shown on Table 3, the reliability statistics of data accepted.

**Table 3 – The reliability statistics with Cronbach’s Alpha**

<b>Mobile World</b>	<b>Value</b>	<b>Pico</b>	<b>Value</b>
Cronbach's Alpha	0.782	Cronbach's Alpha	0.896
Cronbach's Alpha Based on Standardized Items	0.872	Cronbach's Alpha Based on Standardized Items	0.899
Mean	3.440	Mean	3.437
Minimum	3.11	Minimum	3.2
Maximum	3.677	Maximum	3.725
Range	0.556	Range	0.525
Variance	0.026	Variance	0.25

Analyzing demographic characteristics, we found most of the respondents were females (89%) while the corresponding number of male was 11 %. The gap between the number of male and female who are ready for this questionnaire indicates that, to some extent, most shoppers are women and they could remember about their experience easier than others. As can be seen from Figure 2, there was a 85 percentage of customers who have the last visit to Pico or Mobile World was over 3 months ago whereas the corresponding number of others is just below 10 percentage, with the lowest part being at 4.11 percentage.

**Table 4 – The age group of respondents**

<b>Age group</b>	<b>Male</b>	<b>Female</b>
Below 15 years old	0	0
From 15 to 20 years old	0	2
From 20 to 25 years old	10	103
From 25 to 30 years old	5	32
From 30 to 40 years old	3	12
Above 40 years old	1	2
Total	19	151



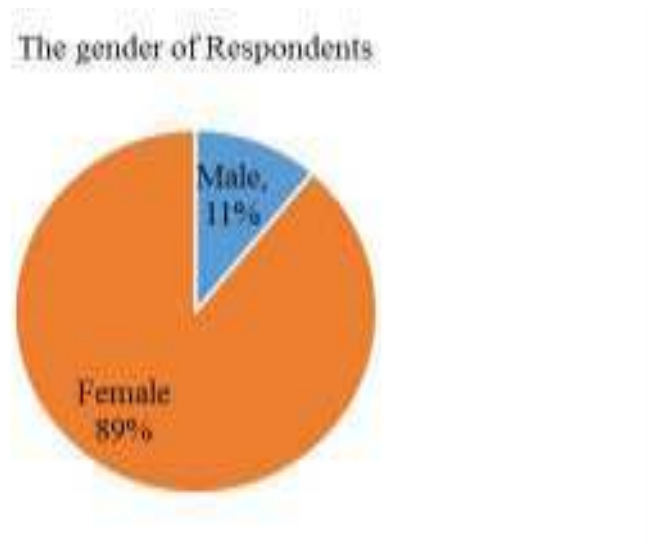

**Figure 1. The gender of respondents**

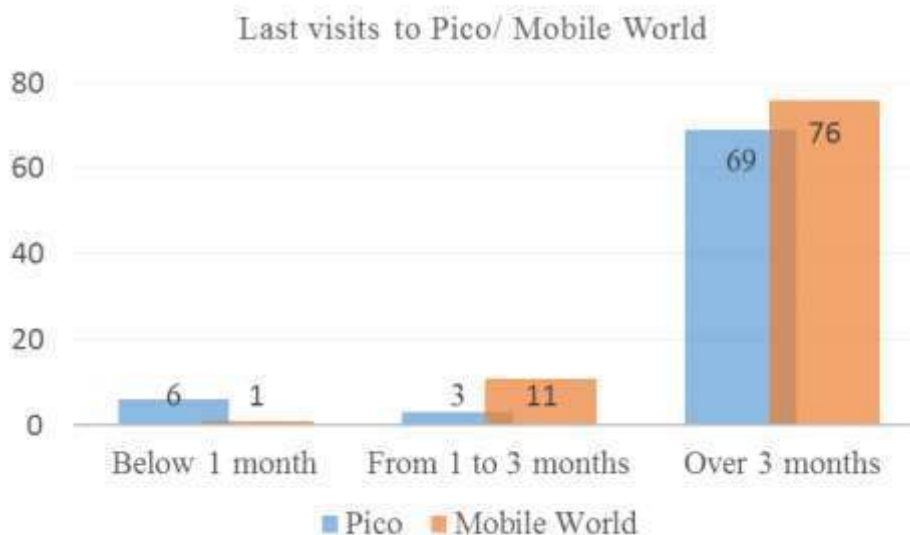

**Figure 2. Customers' last visits to Pico/ Mobile World**

#### Data Analysis

This section describes the data analysis procedure that was used in the study. The research methods include systematization methods, statistical methods, comparative methods for analyzing and interpreting of research results. This research uses two software: (1) Microsoft Excel 2010 with purpose of collecting, systematizing, illustrating the brand image of retailer; and (2) IBM SPSS 20 to analyze primary data and test Cronbach's alpha.

### 3. Results

#### Brand image of Pico

In general, Pico's brand image is quite positive, with most ratings being "Neutral" and "Better". As can be seen from these graphs, there is a significant number of people who had positive experience with Pico, and the most popular level of appreciation is "3 - Neutral" and "4 - Better". Access dimension has the least positive reviews; Promotion and Product – Brand Assortments are somewhat better while the other dimensions such as Staff, Services, In-door atmosphere, Price have the best evaluation.

In particular, the most impressive item is the Acc2: Locations have very good accessibility, with the highest point being at 34.17% of total respondents having the most appreciated reviews. In contract to this, item Acc1: Stores locations are convenient for transportation received worse assessments, with lowest point being at 46.67% of the least

appreciated reviews. While Serv2: Good warranty services and Promo2: Frequently changing promotions have more neutral reviews than others.

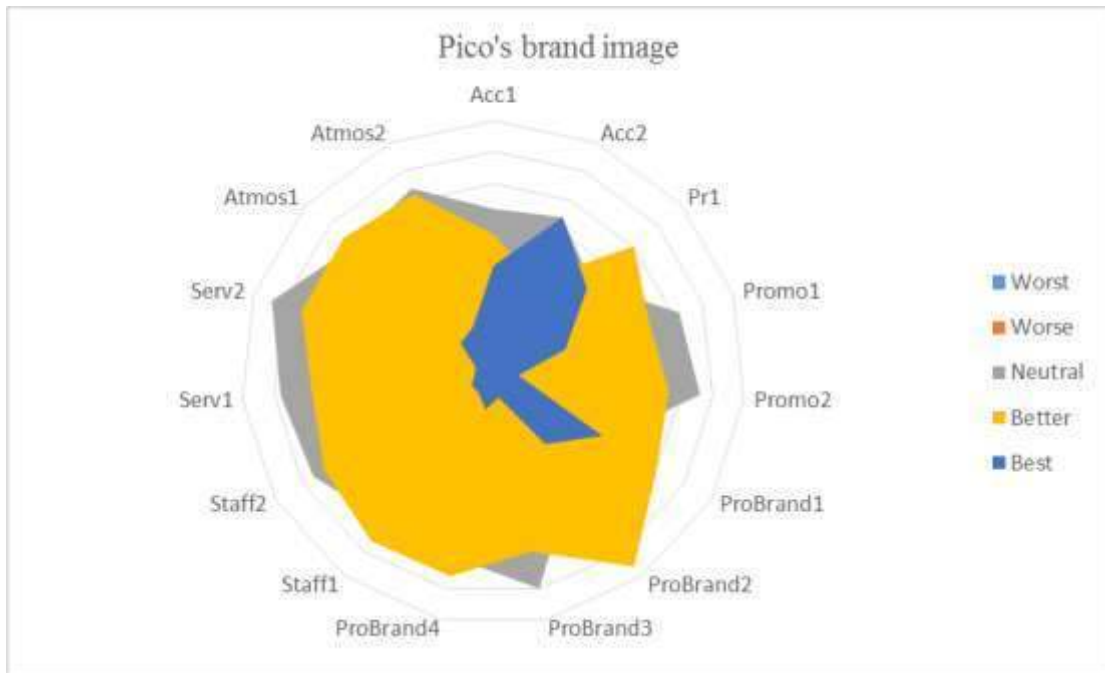

**Figure 3. Pico's overall brand image**

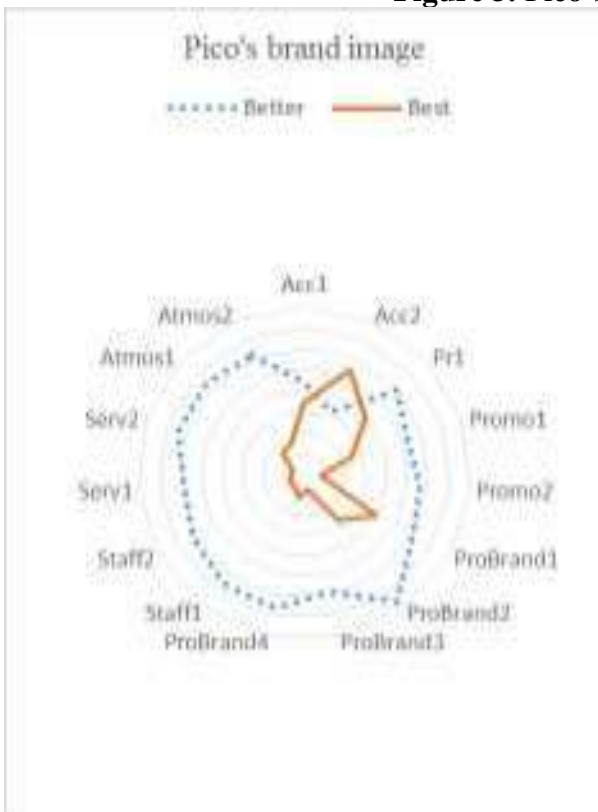

**Figure 4. Pico's brand image with "better" and "best" reviews**



**Figure 5. Pico's brand image with "worse" and "worst" reviews**

Brand image of Mobile World

In general, Mobile World’s brand image is also positive, with most comments being rated at level “Neutral” and “Better”. However, in comparison with Pico’s image, this is a bit less.

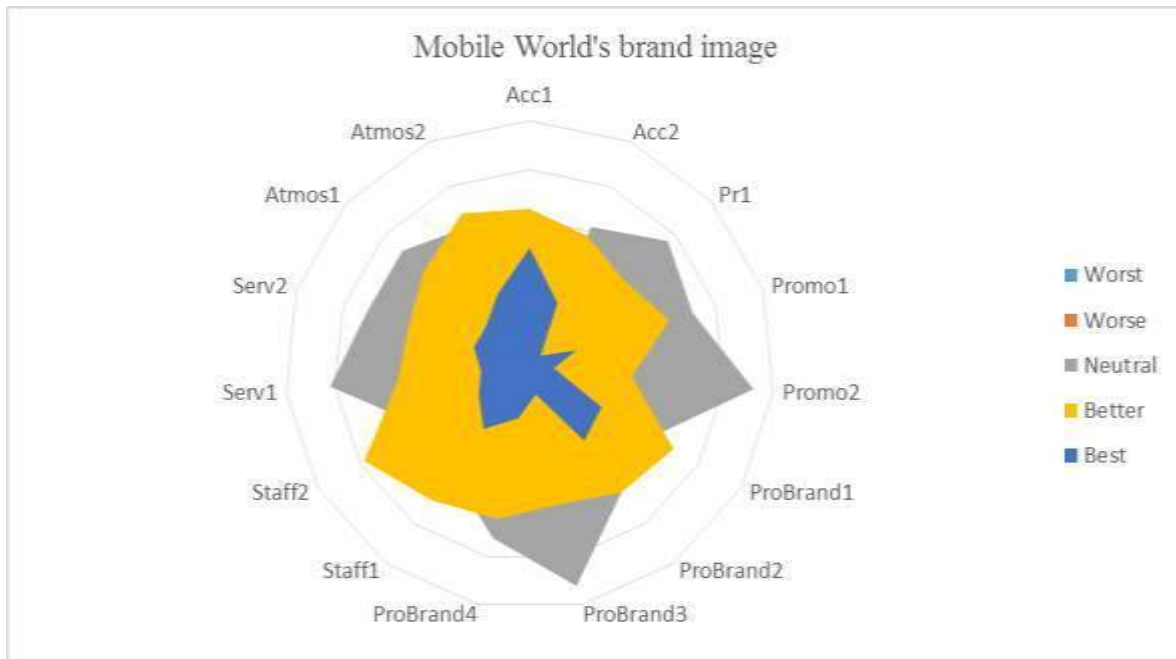

Figure 6. The Mobile World’s overall brand image



Figure 7. Mobile World’s brand image with “worst” and “worse” reviews

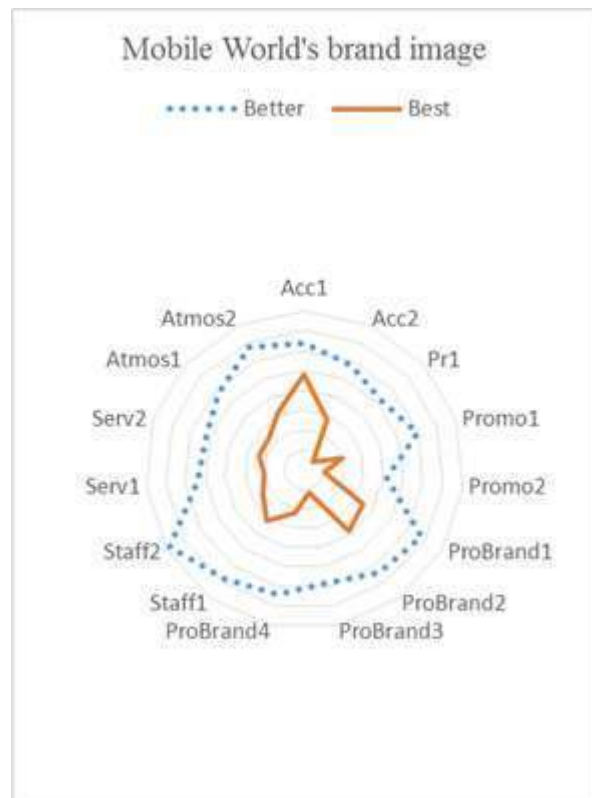

Figure 8. Mobile World’s brand image with “best” and “better” reviews.

As can be seen from these graphs, a majority of consumers say they have positive experience at Mobile World, and the most popular level of appreciation is “3 - Neutral” and “4 – Better”. In general, Price dimension is the worst rated.

In particular, Pr1: The price of goods is suitable received worse assessments, with lowest point being at 25.56% of

the least appreciated reviews. Promo2: Frequently changing promotions and Staff2: Staff have a suitable attitude and behaviour are the next.

In contrast to this, the most appreciated item is the Staff2: Staff have a suitable attitude and behaviour, with the highest point reaching 50.49% of total respondents having the most appreciated reviews. Respectively is ProBrand1: There are a variety of goods and Atmos2: A comfortable space.

#### 4. Suggestions

This research does not expect to offer all suggestions to all retailers because each firm is unique with different attributes as well as resources, so it requires specific branding strategies to achieve strategic goals. Based on this view, the authors' recommendations focus on the general aspects, not on particular details.

Firstly, the most important element of brand image is the staff. Because in retail business, customers come in direct contact and most often with employees, including security guards, salespersons, cashiers and support staff in other services such as installation, warranty, transportation, repair, etc. The actions, words, and attitudes of employees will have a direct impact (positive / negative) on the customer's perception of the store in particular and the brand in general.

Secondly, accessibility is essential. This means the convenient location is a strong point of retailers, but the easy – to – access to approach selling space necessitate improvements. Particularly, in the context of traffic congestion in Hanoi and other major cities, it is necessary to organize a parking space flexible and suitable for buyers. On the other hand, this study also points out the need for an online sales system because there is an increasing number of online customers in Viet Nam.

Lastly, Promotion programs should extend beyond the attractive price. Although Price element still has been the most effective tool for retailers to attract new customer and retain old buyers, increasingly high demands for quality of service as well as product quality requirements would make it impossible for businesses to constantly use discounts to attract smart customers who are ready to pay much more to own “the better”.

### Appendix

#### PICO QUESTIONNAIRE

Dear ladies and gentlemen!

We are doing research about brand of retailer in Viet Nam. Please take time to some to mark (x) in the box of answer. We guarantee that all your information would only be used for scientific research purpose. Thanks for your participation!

Part 1	Brand awareness				
Q1	Please list companies who are doing business in retail in Ha Noi (with point 1 is the most remembering).	1	2	3	4
Q2	Do you remember brand “Pico”?	Yes		No	
Q3	Please tick these main products of this company?	Computers	Household	Delivery	Event Agency
Q4	How far is the time from the present to the last time you went to Pico?	Below 1 month	From 1 – 3 months	Over 3 months	
<b>Part 2</b>	<b>Brand image</b>				
	Mark your choice (x):	1	2	3	4
	(1 – very disagree and 5 – very agree)				

Q5	Store locations are convenient for transportation				
Q6	Locations have an easy access points				
Q7	There are a variety of goods				
Q8	There are many different branded goods				
Q9	There are many up-to-date goods				
Q10	Quality of goods is well controlled				
Q11	The price of goods is suitable				
Q12	There are attractive promotions				
Q13	Frequently changing promotions				
Q14	An apt shopping space				
Q15	A comfortable space				
Q16	There are dedicated staff				
Q17	Staff have a suitable attitude and behaviour				
Q18	Good transportation and installation services				
Q19	Good warranty service				
Q20	If 10 is the best quality, please mark your point for Pico	Point			
<b>Part 3</b>	<b>Brand Identity</b>				
Q21	What do you think about Pico's brand identity system?	Very attractive	Attractive	Normal	Not attractive
Q22	According to you, Pico brand will develop better if any of the following factors? (Ranking from 1 - 10 with 1 being the most important)	Level			
	Price of products				
	The variety of products				
	Quality of products				
	Location of selling stores				
	Shorten the waiting time				
	The attitude of staff				
	Design of space				
	Advertisements and communication				
	Promotions				
	Unnecessary paperwork				
<b>Part 4</b>	<b>Personal Information</b>				

D01	Gender		Male		Female
D02	Age group		15 - 20		
			20 - 25		
			25 - 30		
			30 - 40		
			> 40		

### References

- [1] Ailawadi K.L and Keller, K.L (2004). Understanding retail branding: Conceptual insights and research priorities. *Journal of Retailing*. Vol. 80. pp 331-342
- [2] Allaway, A.W, P. Huddleston, J. Whipple and A. E. Ellinger (2011). Customer - based brand equity, equity drivers, and customer loyalty in the supermarket industry. *Journal of Product and Brand Management*. Vol. 20. Issue: 3. Pp199 – 204
- [3] Jesko Parray, Dennis Spillecke.(2013). *Retail Marketing and Branding*. John Wiley & Sons.
- [4] Kapferer, J.-N. (2008). *The New Strategic Brand Management: Creating and Sustaining Brand Equity Long Term*. London: Kogan Page.
- [5] Huong, N.T. (2017). *The elements of retailer brand in Vietnam: The fact and solutions*. Scientific researches. Thuongmai University.
- [6] Nhan, A.T.T. (2017). Building retailer brand (Part I). *Vietnam Logistics Review Journals*. <https://vlr.vn>. Accessed at 2/2017.

# Determinants of Banks' Profitability: Empirical Evidence from Listed Banks in Vietnam

Phan Dai Thich\*

Banking Academy of Vietnam, Hanoi, Vietnam  
Graduate student at Northeastern University, Shenyang, China

## ABSTRACT

This research paper empirically aims examining the impact of bank-specific factors and macroeconomic variable on the Vietnam listed banks' profitability from 2007-2016 by using the ratios return on assets (ROA) as a proxy of profitability. A total 80 listed banks' financial reports were analysed and the technique of linear multiple regression analysis is employed as the statistical tool. The independent variables include bank specific factors such as: non-performing loan ratio, operating expenses to total assets ratio, total loan to total assets ratio, equity to assets ratio, deposit to assets ratio and inflation ratio as a macroeconomic factor. While the bank-specific factors are found to have a significant impact, inflation ratio is found to be insignificant on affecting the profitability of banks. The findings from this paper not only provide useful suggestions for banks management but also suggest some policy implications for policy makers.

**Keywords:** determinants, impact, profitability, commercial banks.

## 1. Introduction

In early 2007, Vietnam became an official member of the World Trade Organization. After 10 years of WTO integration, Vietnam's banking system has been improved. With the deepening involvement of foreign banks, the competition in banking sector has been increasing. This requires the domestic commercial banks to make changes in corporate governance, increase financial capacity, invest in technology and improve the quality of banking services in order to compete with international banks. After the financial crisis in 2008, the system of commercial banks in Vietnam was influenced with many consequences: arise of bad debt, lack of liquidity at some time. These problems have significantly affected the profitability of banks. Accordingly, the plan of restructuring the financial institutions for the period 2011-2015, issued in conjunction with Decision 254 of the Prime Minister (Project 254), is reforming financial institutions, increasing transparency through the application of new mechanisms of information disclosure, listing shares of commercial banks on the stock market. The banking system in Vietnam comprises of 4 State-owned commercial banks (the State holds more than 50% of charter capital), 31 commercial banks, 8 foreign banks, 2 Joint Venture Banks, 2 Policy Banks and 1 Central People's Credit Fund. (State Bank of Vietnam, 2016). Banking system in Vietnam is dominated by commercial banks, and 9 banks have listed their share on Stock Exchange. However, there is a difference of performance between listed banks. This study is intended to clarify factors affecting the profitability of the listed banks in Vietnam.

This paper is organized as follows: the introduction is the section 1, the next section is the literature review, the section 3 introduces the research methodology, followed by the section 4 that presents the empirical result and discussion. The final section (section 5) is conclusions as well as recommendations.

## 2. Literature review

The determinants of bank profitability have become a major concern of bank manager, investor, policy maker. A variety of researches has been done in term of specific economy, notably such as:

Mamatzakakis, et al (2003) investigated the determinants of the commercial banks' performance in Greek during the

\* Corresponding author. Tel.: +84-4-38526415  
E-mail address: Thichpd@hvn.edu.vn

period 1989-2000. By using the ratios return on assets (ROA) and return on equity (ROE) as a proxy of the profitability of the commercial banks, this study found that the variables related to management decisions had a major impact on the profitability of Greek commercial banks.

Kosmidou, et al (2008) examined the determinants of profitability of UK owned commercial banks over the period for 1995-2002 by using bank-specific factors, macroeconomic factors, and financial market structure as the control variables. The empirical results reveal that while the capital strength of commercial banks has a major impact on banks' profitability, macroeconomic factors: GDP growth and inflation have a positive impact on banks' profitability.

Karimzadeh, et al (2013) investigated the impact of both internal and external factors on Indian banks' profitability from 2003 to 2011. By using a balanced panel data, this paper showed that bank-specific factors: the deposit and loan asset ratio have a significant impact on bank profitability in India. Moreover, this study also found that Bank size variable had a major impact on profitability.

A paper from Turkish banking industry, Acaravci and Calim (2013), studied the impact of the bank specific factors and macroeconomic factors on banks profitability over the period 1998-2011. For this study, return of asset, return of equity and net interest margin were used as proxy for profitability of banks. The results showed that compared with internal factors, external factors have less impact on bank profitability.

Samad (2015) examined the determinants of the performance of Bangladesh banking industry. By using a panel data, the results reveal that bank specific variables such as loan over deposit ratio, loan loss provision over total assets ratio, equity capital over total assets, and operating expenses over total assets ratio have a major impact on banks' profitability in Bangladesh. However, macroeconomic variable (proxied by GDP) found no impact on profitability.

Duraj & Moci (2015) investigate the determinants of the profitability in Albania banking sector. The results suggest that both internal factors (proxied by variables related to management decisions) and external factors (proxied by GDP and inflation) have significant impact on the profitability of the banks.

Relating to Islamic banks, Rahaman & Akhter (2016) investigated the determinants of Islamic banks' profitability in Bangladesh. By using the linear multiple regression analysis and collecting data from 8 Islamic banks over the period 2009-2013, the results suggest that with exception of loan and expense management that are found to have insignificant impact on the profitability of the banks, other variables such as bank size, deposit, equity have significant impact on the profitability (proxied by the return on assets).

There are also some studies conducted to investigate the factors affecting the profitability of banks in a group of different countries.

Athanasoglou et al (2006) studied the impact of bank-specific, industry related and macroeconomic factors in determinant of banks' profitability in South Eastern European (SEE) over the period for 1998-2002. This paper found that most bank-specific factors have significant impacts on bank profitability and the concentration has positive impact. While banking reform found no impact on profitability, the impact of macroeconomic factors is mixed.

Beakmann (2007) investigated structural and cyclical determinants of banking profitability in 16 Western European. This paper found that financial structure matters, particularly through the beneficial effect of the capital market orientation in the respective national financial system.

Furthermore, higher diversification regarding banks' income sources shows a positive effect. The industry concentration of national banking systems, though, does not significantly affect aggregate profitability. Business cycle effects, in particular lagged GDP growth, display a substantial procyclical impact on bank profits.

Flamini et al (2009) analyzed determinants of bank profitability in 41 sub-saharan by using a sample of 389 banks. They found that apart from credit risk, higher returns on assets are associated with larger bank size, activity diversification, and private ownership. Moreover, macroeconomic variables also affect bank returns.

Shaher et al (2011) analyzed the determinants of commercial banks' performance in the Middle East Region. The findings show that bank-characteristic variables have the most significant impact on banks' performance.

#### **In Vietnam:**

Ngo (2012) analyzed and measured the performance of banking system in Vietnam by using DEA method. The empirical results have found that decreasing in banking performance can be explained by an increase of the size of banking sector, more liberation of financial market and facing problems in the world and regional economies.

Vu & Nahm (2013) investigated the impact of bank-specific characteristics, transitional environment, ownership structure and macroeconomic variables in determining the banks' profit efficiency in Vietnam during the period 2000-2006 by using a Tobit model. The empirical results show that larger size of bank and better ability of management have a positive impact on the profit efficiency of a bank. However, low quality of assets and a too high level of capitalization have a negative impact on profit efficiency. The impact of macroeconomic factors such as per-capital GDP and inflation is mixed.

Son et al (2015) used panel data from 2010-2012 from 44 banks in Vietnam to investigate the impacts of ownership structure on bank performance. Research results show that capital concentration and private ownership have positive impact on bank profitability, the non-performing loan ratio has negative relation with banks' profitability.

Nguyen & Bui (2015) investigated factors that impact on profitability of the commercial banks in Vietnam. This paper found that the equity to total assets ratio, the loans to total assets ratio, the liquidity ratio and the economic growth rate have significant and positive impact on the commercial banks' profitability in Vietnam.



According to the literature review above, we can come to conclusion that:

Firstly: Many empirical studies covered developed and developing countries. And, in studying determinants of profitability of banking sector, researchers usually chose ROA, ROE or NIM as a proxy of profitability of banks.

Secondly: most of papers traditionally mentioned two types of factors (internal and external factors) in studying the factors that affect banks' profitability. Internal factors (bank-specific factors or bank-characteristic factors) are the factors influenced by the bank's management decisions. External factors, or uncontrolled factor, are factors being beyond the control of the bank such as economic growth, inflation, or operating rate of monetary policy of the central bank.

Thirdly: there is a little research on the determinants of banks' profitability in Vietnam, except Vu & Nahm (2013) and Nguyen & Bui (2015).

The paper contributed to the banking literature. First, the paper use panel regression as a research tool in determining profitability. Second, the paper clarifies the most significant factors on the profitability of listed banks in Vietnam. In compared with Vu & Nahm (2013), this paper covers latest data from banking sector. Moreover, this paper adds more variables such as: inflation rate and operating expense than Nguyen & Bui (2015). Finally, the findings of this provides useful suggestions to bank management.

### 3. Research Methodology

This study aims to analyze the determinant of banks' profitability of all Vietnam Listed Banks. This paper is based on panel dataset covering all listed banks of Vietnam over the period of 2007-2016. Because of insufficient data from a bank for 10 years from 2007 to 2016, therefore the study use data from 8 listed banks. Total assets of these 8 listed banks account for about 55 percent of total assets in banking sector as at the end of 2016. Data of all bank-specific characteristics such as Non-Performing Loan (NPL), operating expense, equity, asset, deposit, loan and ROA are obtained from bank's annual reports from 2007-2016. Data for macroeconomic variable inflation is obtained from Vietnam General Statistic.

According to literature review mentioned above, we use the following ratios to evaluate the banks' profitability.

- Return on Assets (ROA): ROA is the ratio of net income to total assets. This paper use ROA as a dependent variable. ROA is considered the best proxy of profit (Flamini et al 2009 and Samad 2015).

- Non-performing loan ratio (NPL): this ratio is measured by dividing the non-performing loan to total loan. This ratio is the main indicator of credit risk management. The lower non-performing loan ratio can lead to a reduction of the cost related to manage bad debt, therefore, higher profitability banks can make. Son et al (2015) found that NPL has negative and significant impact on ROA and ROE. In this study, NPL is expected to have a negative relation with profitability of bank.

- Equity to Assets ratio: is the ratio of bank's equity capital to total assets. Equity to total assets ratio reveals the capital adequate. Equity management is an important part of banking management, especially higher capital adequate helps the bank mitigate risks related to mass withdrawals. Higher this ratio, the lower the capital cost of the bank, thereby increasing profitability. Samad (2015) found that equity capital to total assets ratio have a significant and positive impact on ROA of Banks. Almazari (2014) found that the profitability of Saudi banks and Jordanian banks has a positive and significant correlation with total equity to assets ratio. In this study, it is expected that Equity to assets ratio has positive impact on profitability.

- Operating Expense to Assets ratio: It is measured by bank's operating expense as the percentage of total assets. Athanasoglou (2006) studying determinants of bank profitability in the South Eastern European region found that operating expense to total assets has a negative and significant effect on profitability. A bank spends high operating expense the profitability could be reduced, therefore operating expense to assets ratio is expected to have negative impact on profitability.

- Deposit to Assets ratio. This ratio is considered as a main indicator of liquidity of bank. Zaman (2011) investigating determinants of top 10 banks' profitability in Pakistan over the period 2004-2008 found that deposit to assets ratio has positive and significant relationship with profitability indicator ROA. This ratio also was used by Karimzadeh et al (2013) in studying correlation between internal variables and level of profitability in India and found that Deposit to assets ratio has a positive impact on the profitability of banks. It is expected that deposit to assets ratio has a positive relation with profitability.

- Loan to Assets ratio: until now the impact of this variable on profitability of banks is different. Research from Mamatzakis & Remoundos (2003), Hassan & Bashir (2003) and Staikouras & Wood (2003) found that Loan - assets ratio has positive impact on profitability of banks. However, the study from Vong (2005) and Vong & Chan (2009) found that is negative sign. The reason to explained the difference results is that high competition in credit market lead to a reduction of Loan even though that is the main income of banks, specially in the period after financial crises.

- Inflation ratio: Athanasoglou et al (2006) and Hefferman and Fu (2008) found that macroeconomic variable (proxied by inflation rate) had positive impact on the profitability of banks. Revell (1979) concluded that the level of inflation can be used to explain the changes of banks' profitability. In contrast, recently Dujai and Moci (2015) found that inflation rate had negative impact in the profitability of the banking sector. Specially, Demircuc-Kunt and

Huizingga (1999) studying determinants of commercial bank interest margins and profitability in 80 countries found that there is a negative relation between inflation and profitability in developing countries. It can be explained that higher inflation leads to that the cost increase higher than the revenue.

**Table 1: Definition of variables**

Variable	Hypothesized relationship with profitability	
<b>The dependent variable</b>		
ROA	The return on average total assets of bank	
<b>The bank-characteristic variables</b>		
NPL	Non-Performing Loan/ Total Loan	-
EQA	Equity/ Total Assets	+
OPEAS	Operating Expense / Total Assets	-
DPAS	Total Deposit/ Total Assets	+
LOANAS	Total Loan/ Total Assets	+/-
<b>The macroeconomic variable</b>		
INF	Inflation Rate (CPI)	+/-

**Table 2: Descriptive statistic of dependent and all independent variables**

	ROA	NPL	EQA	OPEAS	DPAS	LOANAS	INF
<b>Mean</b>	0.0127813	0.0197338	0.0838674	0.0150094	0.7846567	0.5719520	0.0911900
<b>Median</b>	0.0123000	0.0179500	0.0741814	0.0143183	0.8084192	0.5783061	0.759000
<b>Standard Deviation</b>	0.0070330	0.0151585	0.0360183	0.0046438	0.1222931	0.1212960	0.0644300
<b>Minimum</b>	0.0002000	0.0008000	0.0425558	0.0018269	0.3100068	0.3307789	0.0063000
<b>Maximum</b>	0.0330000	0.0880000	0.2662079	0.0270488	0.9237704	0.82070668	0.2297000
<b>Count</b>	80	80	80	80	80	80	10

There are some major advantages in using panel data regression model. Firstly, Panel data provides more reliable estimated results. Secondly, panel data allows us to identify and measure the impact that can not be identified and measured on the use of cross-data or time series data. Therefore, this study applies Panel Ordinary least square (OLS) for estimating the impact of bank-specific variables and macroeconomic variable on banks' profitability.

We have model as follows:

$$ROA_{i,t} = \beta_0 + \beta_1 NPL_{i,t} + \beta_2 EQA_{i,t} + \beta_3 OPEAS_{i,t} + \beta_4 DPAS_{i,t} + \beta_5 LOANAS_{i,t} + \beta_6 INF_t + \varepsilon_{it}$$

Where:

$ROA_{i,t}$ : the profitability of bank i in year t

$NPL_{i,t}$ : Non-performing loan ratio of bank i in year t

$EQA_{i,t}$ : the equity total assets ratio for bank i in year t

$OPEAS_{i,t}$ : the operating expense to total assets ratio for bank i in year t

$DPAS_{i,t}$ : the deposit to total assets for bank i in year t

$LOAN_{i,t}$ : the loan to total assets for bank i in year t

$INF_t$ : the inflation ratio in year t

**Tables 3: Correlation coefficient between variables in the research model**

Independent variable	ROA	NPL	EQA	OPEAS	DPAS	LOANAS	INF
<b>ROA</b>	1						
<b>NPL</b>	-0.323045	1					
<b>EQA</b>	0.377236	0.01558	1				
<b>OPEAS</b>	-0.368787	0.109279	-0.127354	1			
<b>DPAS</b>	0.044663	-0.119814	-0.135368	0.241212	1		
<b>LOANAS</b>	-0.590158	0.038652	-0.30009	0.473071	0.258533	1	
<b>INF</b>	0.374358	0.046146	0.199398	0.056652	-0.135892	-0.432751	1

The results from table 3 shows correlation coefficient between variables in the research model. The correlation analysis points out that Equity/asset ratio, Deposit/ asset ratio, and inflation have positive relationship with ROA, while Non-performing loan, Operating expense/ asset ratio and Loan/ asset ratio have negative relationship with ROA.

#### 4. Empirical Results and Discussion

In order to select the suitable model for our study, we run a Hausman Test before applying Random Effect Model. Table 4 shows that P-value from Hausman Test is 35.26% (more than 5%) so we accept Random effect model as a suitable model.

**Table 4: Hausman Test**

Test Summary	Chi-Sq. Statistic	Chi-Sq. d.f.	Prob.
Cross-section random	6.668203	6	0.3526

**Table 5: Random effect regression results**

Variable	Coefficient	Prob.
Constant	0.021106	0.0002
NPL	-0.101417	0.0062
EQA	0.061688	0.0006
OPEAS	-0.316914	0.0408
DPAS	0.011549	0.0552
LOANAS	-0.030008	0.0003
INF	0.014914	0.1438
R <sup>2</sup>	0.593053	
Adjusted-R <sup>2</sup>	0.559605	
F-statistic	17.73073	
D_W	1.412916	

The table 5 presents that the empirical results of regression of model using ROA as a proxy of the profitability of bank. The adjusted R-squared of 56% shows that this model is significant while the 56 % of variability of the bank profitability measured through ROA is explained through the variance of the factor we took in this study as determinants in the bank profitability.

From the result of random effect regression, showing that the value for the F-statistic is 17.73 and is high significant to show the appropriateness of the model.

- Non-performing loan ratio: This variable has a significant and negative impact on profitability of the listed banks. This result is in line with prior studies by Son et al (2015). This problem will not be an easy problem for Vietnamese banks in the short term. Higher non-performing loan ratio lead to an increase in the bank's operating costs, affect the efficient of using capital and create a great pressure on the liquidity of the bank and the whole banking system.

- Equity to Assets ratio. The result shows that Equity to Assets ratio has significant and positive impact on ROA. This result is consistent with the conclusion of earlier studies of Mamatzakis & Remoundos (2003), Hassan & Bashir (2003), Bourke (1989), Zaman et al (2011) and Almazari (2014). This can be explained by, after the 2008 financial crisis, banks in Vietnam are classified as small banks so that equity contribute significantly to banks in order to recover from shock in international financial markets and in domestic liquidity, as well as reduce the costs of borrowing.

- Operating Expense to Assets ratio. This variable has significant and negative impact on profitability of banks. Same results have been found by Athanasoglou et al (2006), Zaman (2011), Samad (2015). This result presents the difficult situation of the banking system in Vietnam during this period. The increase of bad debt forced banks to be more cautious about new lending, therefore, the cost of dealing with bad debts and the increase in pre-lending costs have eroded the banks' profits. This results also is supported by study from Mamatzakis & Remoundos (2003), this paper found that personnel expenditure over total asset has significant and negative relation with profitability. The result is also in line with expected relationship.

- Deposit to Assets ratio. This variable has positive impact on profitability but the statistic value is insignificant.

- Loan to Assets ratio. This variable has significant and negative impact on profitability of banks. This result can be explained by that non-performing loan increased in the studied period. Another reason is that as a result from lack of liquidity the competition in lending market taking place among commercial banks lead to reduction of profitability of banks. This result also finds the similarity in the studies of Vong (2005), Vong & Chan (2009) and Acaravci & Calim (2013).

- Inflation ratio: the sign for this macroeconomic factor, INF, is positive, but it is not a significant factor to Vietnam listed banks profitability. The impact of inflation on banks performance depend on the bank's management (Perry, 1992). By properly predicting inflation, the revenue can be made faster than cost. The reason to explain this result in Vietnam is that as an immature banking industry, this period witnessed a variety of problems such as: bad debts, lack of liquidity, high competition with foreign banks that make an insignificant impact of inflation on profitability though there is an improvement in forecasting inflation.

## 5. Conclusion:

The main aim of the study is to examine the impact of bank-specific factors and macroeconomic variable on the Vietnam listed banks' profitability over the period for 2007-2016 by using the return on assets ratio (ROA) as a proxy of profitability. The previous findings in the literature are examined. The results from this study found that bank specific factors such as non-performing loan ratio, operating expenses to total assets ratio and total loan to total assets ratio have significant negative impact on the return on assets, while equity to assets ratio is found to have a positive significant impact. However, deposit to assets ratio and inflation ratio are found to be insignificant an affecting the profitability of banks.

Based on these findings, this research suggests some practical recommendations for banks in Vietnam

Firstly: in order to increase the profitability, bank management should quickly resolve the bank's bad debt as well as improve asset quality management. Each bank should have a detail plan to deal with NPL and put their effort to keep

Secondly: in compared with international banks, banks in Vietnam should enhance equity and implement modern technologies to reduce operating costs, increase operating efficiency. Financial liberalization in the Asian area is expanding. To compete with other banks in the region, Vietnam banks should have plans to increase chartered capital. This is the basic foundation for banks to compete and expand their market share in the future. This helps to increase financial capacity as well as an opportunity to learn modern banking management from large financial corporations in the region.

Last but not least, some policy implications are proposed as a way of improving the efficiency of banking sector in Vietnam. First, as banking sector plays an important role in the economy, researcher encourage that dealing with bad debt and restructuring banking system should be one of the top priorities of the state bank in the short term. Second, at the present time, the increase in operating expenses of commercial banks comes primarily from the cost of dealing with bad debt, but in the future the investment in improving the information technology platform, promoting e-banking services will help banks reduce operating costs in the long run as well as increase operating efficiency. Therefore, in terms of policy formulation, the State Bank of Vietnam should have policies to promote and encourage commercial banks to invest in upgrading their information technology systems and deploying e-banking services.

## References

- [1] Acaravci, S. K., & Calim, A. E. (2013). Turkish banking sector's profitability factors. *International Journal of Economics and Financial Issues*, 3(1), 27.
- [2] Al Shaher, T., Kasawneh, O., & Salem, R. (2011). The major factors that affect banks' performance in Middle Eastern countries. *Journal of Money, Investment and Banking*, issued, 20.
- [3] Almazari, A. A. (2014). Impact of internal factors on bank profitability: Comparative study between Saudi Arabia and Jordan. *Journal of Applied finance and banking*, 4(1), 125.
- [4] Athanasoglou, P., Delis, M., & Staikouras, C. (2006). Determinants of bank profitability in the South Eastern European region.
- [5] Beckmann, R. (2007). Profitability of Western European banking systems: panel evidence on structural and cyclical determinants.
- [6] Bourke, P. (1989). Concentration and other determinants of bank profitability in Europe, North America and Australia. *Journal of Banking & Finance*, 13(1), 65-79.
- [7] Dang-Thanh, N. (2012). Measuring the performance of the banking system: case of Vietnam (1990-2010).
- [8] Demirgüç-Kunt, A., & Huizinga, H. (1999). Determinants of commercial bank interest margins and profitability: some international evidence. *The World Bank Economic Review*, 13(2), 379-408.
- [9] Duraj, B., & Moci, E. (2015). Factors influencing the bank profitability-empirical evidence from albania. *Asian Economic and Financial Review*, 5(3), 483.
- [10] Flamini, V., Schumacher, M. L., & McDonald, M. C. A. (2009). The determinants of commercial bank profitability in Sub-Saharan Africa (No. 9-15). *International Monetary Fund*.
- [11] Hassan, M. K., & Bashir, A. H. M. (2003, December). Determinants of Islamic banking profitability. In 10th ERF annual conference, Morocco (pp. 16-18).
- [12] Heffernan, S., & Fu, M. (2008). The determinants of bank performance in China.
- [13] Karimzadeh, M., Akhtar, S. J., & Karimzadeh, B. (2013). Determinants of profitability of banking sector in India. *Transition Studies Review*, 20(2), 211-219.
- [14] Kosmidou, K., Tanna, S. and Pasiouras, F. (2008) Determinants of profitability of domestic UK commercial banks: panel evidence from the period 1995-2002. (Economics, finance and accounting applied research working paper series no. RP08-4). Coventry: Coventry University. <http://www.coventry.ac.uk/bes/cubs/aboutthebusinessschool/Economicsfinanceandaccounting/Pages/AppliedResearchWorkingPapers.aspx>
- [15] Mamatzakis, E., & Remoundos, P. (2003). Determinants of Greek commercial banks, 1989-2000. *Spoudai*, 53(1), 84-94.
- [16] Ngoc Nguyen, T., & Stewart, C. (2013). Concentration and efficiency in the Vietnamese banking system between

- 1999 and 2009: a structural model approach. *Journal of Financial Regulation and Compliance*, 21(3), 268-283.
- [17] Nguyen & Bui (2015). Factors impact on profitability of commercial banks in Vietnam. *Australian Journal of Basic and Applied Sciences*, 9(23), 105-110.
- [18] Perry P (1992) Do banks gain or lose from inflation? *J Retail Banking* 14:25–30
- [19] Rahaman, M. M., & Akhter, S. (2016). Bank-Specific Factors Influencing Profitability of Islamic Banks in Bangladesh. *Journal of Business and Technology (Dhaka)*, 10(1), 21-36.
- [20] Samad, A. (2015). Determinants bank profitability: Empirical evidence from bangladesh commercial banks. *International journal of financial research*, 6(3), 173.
- [21] Son, N. H., Tu, T. T. T., Cuong, D. X., Ngoc, L. A., & Khanh, P. B. (2015). Impact of Ownership Structure and Bank Performance–An Empirical Test in Vietnamese Banks. *International Journal of Financial Research*, 6(4), 123.
- [22] Staikouras, C., & Wood, G. (2003, June). The determinants of bank profitability in Europe. In *European Applied Business Research Conference, Venice (Vol. 913)*.
- [23] Sufian, F., & Habibullah, M. S. (2009). Bank specific and macroeconomic determinants of bank profitability: Empirical evidence from the China banking sector. *Frontiers of Economics in China*, 4(2), 274-291.
- [24] Vong, L. K. (2005). Loans and profitability of banks in Macao. *AMCM Quarterly Bulletin*, 2, 91-107.
- [25] Vong, P. I., & Chan, H. S. (2009). Determinants of bank profitability in Macao. *Macau Monetary Research Bulletin*, 12(6), 93-113.
- [26] Vu, H. T., & Turnell, S. (2010). Cost efficiency of the banking sector in Vietnam: A Bayesian stochastic frontier approach with regularity constraints. *Asian economic journal*, 24(2), 115-139.
- [27] Vu, H., & Nahm, D. (2013). The determinants of profit efficiency of banks in Vietnam. *Journal of the Asia Pacific Economy*, 18(4), 615-631.
- [28] ZAMAN, S. J. J. A. K. (2011). Determinants of bank profitability in Pakistan: Internal factor analysis. *Journal of Yaşar University*, 6(23), 3794-3804.

# Effects of Organizational Culture to Employees' Satisfaction and Cohesion in Tourism Accommodation Enterprises of Thanh Hoa Province

Le Thi Binh, Pham Thi Bich Thu

Hong Duc University, Thanh Hoa province, Vietnam

---

---

## ABSTRACT

The research evaluates the impact of organizational culture on satisfaction and cohesion of employee's organizations in tourism accommodation enterprises in Thanh Hoa. The research uses the following data analysis methods: the exploratory factor analysis (EFA), confirmatory factor analysis (CFA), and structural equation analysis (SEM). The research suggests the model in which organizational culture includes five components: positive communication in the enterprise; training and development; commendation and recognition; working environment and equity and cohesion of employee's organization. The cohesion is also measured by three components: affective commitment, normative commitment and continuance commitment. In addition, there is a positive relationship between organizational culture and employee's satisfaction, then organizational culture has a positive impact on employee's cohesion with the organization. From the results of the study, the author proposes a number of management implications for leaders to increase employee's satisfaction, thereby encouraging employees to engage with the organization.

**Keywords:** Accommodation enterprise of Thanh Hoa, Employee's Cohesion, Employee's satisfaction, Organizational culture.

---

---

## 1. Introduction

Organizational culture has ability to greatly affect to the thoughts, emotions, employee's satisfaction with the organization, and thereby create cohesion and effective communication on organization. Therefore, building organizational culture is very important to create a favorable environment, help employees feel the spirit of encouragement and stick with the enterprise. A lot of Vietnamese enterprise, especially those engaged in tourism accommodation enterprise, are attaching great importance to building organizational culture for their own enterprise in order to create their own identity and have a lot of enterprises built successfully organizational culture .

The managers of Thanh Hoa tourism accommodation enterprise always expect to improve human resource management, create a organizational culture and a favorable working environment, enthusiastic sticking longer and contribute more to the organization. But so far, little research has been done on this issue. Therefore, the study of "Effects of organizational culture to satisfaction and of employees's cohesion with organization in tourism accommodation enterprises of Thanh Hoa" is essential to improve the competitiveness and efficiency of tourism accommodation enterprise of Thanh Hoa in the current period.

## 2. Literature Review

### 2.1. Organizational culture

According to E.H. Schein, organizational culture is defined as a system of assumptions, values, norms, and attitudes and rituals that all of them are unique to a known organization. Deal and Kennedy (1982) identify organizational culture as the identity of the business and affect the emotions, reasons and behavior of all members. Culture is a set of striking features that distinguish businesses (Hofstede, 1991, Robbins et al., 2010).

The studies of Ricardo and Jolly (1997), Meyer and Allen (1991) argue and verify that corporate culture influences employee engagement with the organization. Ricardo and Jolly (2001) identified communication, training/development, rewards/recognition, effective decision-making, risk-taking for creativity and innovation, proactive learning, team work, and fairness and consistency in most practice as dimensions of organizational culture. These factors represent corporate culture at the first and second levels in Schein (2004).

Mintzberg (1991) recommends that effectiveness of the organization can occur once the interaction of seven basic forces; direction, efficiency, proficiency, innovation, concentration, cooperation/culture and competition/politics are managed effectively. Effectiveness of the organization is measured in terms of 4 indicators; client orientation, worker satisfaction, commitment within the organization and monetary and growth performance. Meanwhile, Ginevicius and Vaitkunaite (2006) proposed 12 factors with 48 criteria for measuring corporate culture. Elements measured organizational culture include 1) involvement, 2) cooperation (collaboration), 3) transmission of information, 4) learning, 5) care about clients, 6) adaptability, 7) strategic direction, 8) reward and incentive system, 9) system of control, 10) communication, 11) agreement, 12) coordination and integration.

Studies show that corporate culture is expressed through the atmosphere of working environment, the beliefs and attitudes among colleagues, the core values of the business which will bring satisfaction and commitment for employees in the organization. In addition, workers also concern the fairness maintained in the enterprises. The theory of fairness of Adam (1963) suggests that employees tend to judge fairness by comparing their efforts compared to what they receive, and compare with their co-workers in company. If the results are equal, that is fair, they will maintain their efforts and performance for their works.

In Vietnam, Truong Hoang Lam (2012) concludes that there are seven cultural factors that influence staff's commitment of staff: (1) communication within the organization; (2) training and development; (3) reward and recognition; (4) risk-taking for creativity and innovation; (5) teamwork; (6) fairness and consistency of governance policies; and (7) effective decision-making.

## **2.2. Job satisfaction**

There are many different concepts of job satisfaction. Spector (1997) argues that job satisfaction is a job-loving attitude in general, and the workplace in particular. According to Fink (1992), employee satisfaction is understood to be a happy feeling with the results received from the organization over the expectations for the quality of work, relationship and working environment. In addition, Kreitner and Kinicki (2007) job satisfaction as an affective or emotional response towards one's job. There have been some studies on the impact of corporate culture on employee satisfaction (Aarons & Sanitzky, 2006a; Shaz et al., 2010; the study's results show that corporate culture has a positive impact on satisfaction of the employees at work.

## **2.3. The model of employment's engagement with organization**

Mowday et al. (1982) defined the staff's commitment to the organization as the strength of personal and organizational integration and active participation in the organization. Employees who demonstrate a high degree of commitment to the organization will be more satisfied with their work and will rarely deny job responsibilities or leave the organization.

Meyer and Allen (1991) also defined commitment to the organization as a psychological state reflected the employee's relationship with the organization, a promise to the organization, and a close association with the organization. Meyer and Allen define the three components of commitment: affective commitment: the employee's positive emotional attachment to the organization; Continuance commitment: refers to commitment by perceiving the values involved when leaving the organization; normative commitment: The individual commits to and remains with an organization because of feelings of obligation. These commitment states help managers to know what their employees are attached to.

The Meyer and Allen models are reliable and widely used as a basis for worldwide researches in the field. Therefore, in the study, the author uses Meyer and Allen (1991) model to measure employee engagement with the organization.

## **2.4. The relationship between job satisfaction and organizational engagement**

There are many studies that show the positive relationship between employee engagement with the organization and expected outcomes at work such as performance, adaptability and job satisfaction (Angel et al. Perry, 1981; Hunt et al., 1985). Porter et al. (1974) argue that in the model of job satisfaction - job engagement is the cause of employee bonding with the organization. Employees with highly job satisfaction tend to work more actively, be punctual, be efficient, and engage in good organizational behaviors (Aamodt, 2007).

## 2.5. The research model

Based on the research models of Ricardo and Jolly (1997), Meyer and Allen (1991); Zain et al. (2009); Shah et al. (2012); Ashkanasy et al., Aydin and Ceylan (2009); Ginevicius and Vaitkunaite (2006), the author suggests a research model studied the influence of organizational culture on the employees' satisfaction and commitment in the tourism businesses of Thanh Hoa province.

**Figure 1: The suggested research model**

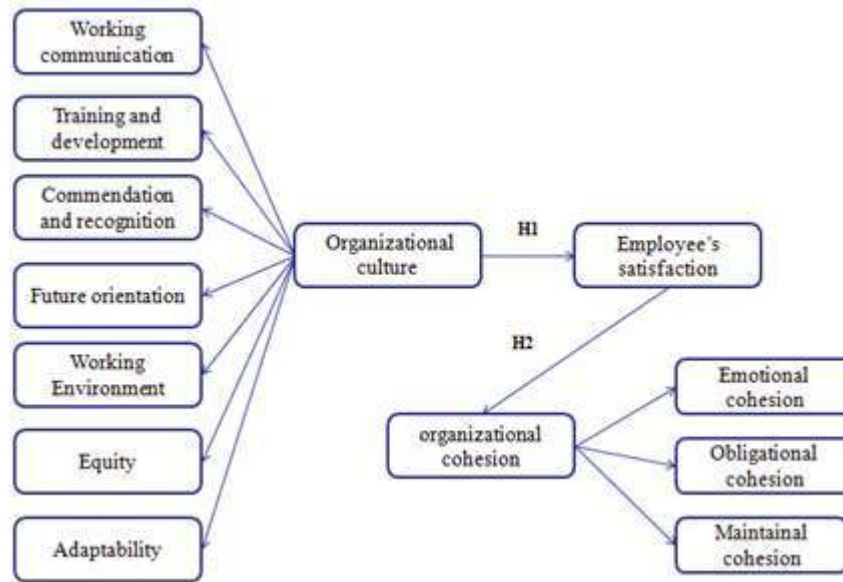

From the research model, there are two hypotheses suggested

H1: Corporate culture has a positive impact on employee satisfaction

H2: Employee satisfaction has a positive impact on engagement with the organization

## 3. The research method

### 3.1. Research design

The research has been conducted through interviews of employees in 30 enterprises in Thanh Hoa City, Sam Son City and Hai Hoa City (Tinh Gia) where have the most standard accommodation enterprises. By the non-probability sampling method, the sample subject is selected based on the scholar's assessment (Black, 2010). Time for carrying out the survey is from March to the end of May of year 2017.

### 3.2. Sample size

Hari & Associates (1998) recommends that if the sample size is around 100, the loading factor standard must be greater than 0.5. Bollen (1989) proposed the ratio of 5 observations per estimated parameter in the multivariate analysis. In the research, there are 42 variable observations, so the minimum sample size should be equal to  $42 * 5 = 210$  samples. 330 questionnaires are sent to employees of 30 tourism accommodation enterprises in Thanh Hoa, the valid questionnaires collected is 320 samples.

### 3.3. Scale

All scales of concepts in the study are multivariate scales. Liker scale with 5 points (1: Strongly disagree, 2: Disagree, 3: Neutral, 4: Agree, and 5: Strongly agree) is used to measure the observed variables. Scales are formed on the basis of inheriting previous studies and consultation with experts (Appendix A1).

### 3.4. Analytical methods

The research uses following methods: the exploratory factor analysis (EFA), confirmatory factor analysis (CFA), and structural equation model (SEM) with SPSS. 20 software in combination with AMOS. 20. Cronbach's Alpha testing is used to evaluate the reliability of the scale of variables, and to eliminate the inadequate variables.



Exploratory factor analysis is for developing a scale and identifying an underlying relationship between measured variables. The confirmatory factor analysis is used to redefine univariate, multivariate, convergent and discriminant values of concepts. From the CFA results, structural equation analysis is used to construct and validate relevance of the research model and also assess the impact level of independent variables on the dependent variable.

#### 4. Results and Discussion

##### Reliability testing

After removing the variables with Corrected Item-Total Correlation  $< 0.3$  TRADEV1, COMRE5, FUTOR4, EQTY4, MAICOH1 all remaining scales have Cronbach's Alpha reliability coefficients greater than 0.6 and all observed variables left have a total variable correlation more than 0.3. Therefore, the scales are reliable and 38 variables are retained for exploratory factor analysis (EFA) (Appendix A2).

##### Exploratory factor analysis (EFA)

The exploratory factor analysis uses Principal Axis Factoring extraction method by

Varimax rotation. According to Gerbing & Anderson (1988), the Principal Axis Factoring extraction method with Promax (Oblique) rotation will reflect the data structure more precisely than the Principal Components extraction method with Varimax (Orthogonal) rotation.

##### Exploratory factor analysis of the Organizational Culture Scale

To evaluate whether an exploratory factor analysis is suitable for analysis in this case, the authors use the KMO and Bartlett's test. In the exploratory factor analysis, the KMO index (Kaiser-Meyer- Olkin) is used to examine the suitability of factor analysis. The KMO value must be between 0.5 and 1, and if the value is less than 0.5, factor analysis may not be appropriate for the data. The KMO test results of the study are as follows (after eliminating WOREN1 variable due to its factor loading less than 0.5 )

**Table 1. KMO and Bartlett's Test**

Kaiser-Meyer-Olkin Measure of Sampling Adequacy.		.828
Bartlett's Test of Sphericity	Approx. Chi-Square	2620.474
	df	253
	Sig.	.000

(Source: Processing of the author's data)

The KMO and Bartlett's test showed  $KMO = 0.828$  ( $0.5 \leq KMO \leq 1$ ); Bartlett's Test statistic = 2620.474 with a  $Sig = 0.00 < 0.05$  (Table 1), it means that the application of exploratory factor analysis in the study is appropriate. Moreover, seven factors have the eigenvalue  $> 1$  which explains is greater than 50%, the observed variables are grouped exactly as the initial scale (Table 2).

**Table 2: Results of the EFA of Organizational Culture Scale**

COMRE3	.795						
COMRE2	.741						
COMRE4	.720						
COMRE1	.621						
WCOM2		.838					
WCOM1		.764					
WCOM3		.728					
WCOM4		.604					
EQTY3			.784				
EQTY1			.726				
EQTY2			.662				
TRADEV2				.755			
TRADEV4				.740			
TRADEV3				.738			
FUTOR1					.795		
FUTOR3					.738		
FUTOR2					.584		
WOREN3						.808	
WOREN2						.699	

WOREN4						.607	
ADAPTA1							.722
ADAPTA2							.675
ADAPTA3							.661

(Source: Processing of the author's data)

Exploratory factor analysis of the organizational cohesion scale

The result obtained was a coefficient of KMO = 0.749 > 0.5, Bartlett's Test statistic was 897,402 with a significance level of 0.000 < 0.05 (Table 3), which proves that the analysis data is consistent. All factors loading were greater than 0.5, the explanatory variance was greater than 50%, the observed variables were grouped exactly as the initial scale (Table 4).

**Table 3. KMO and Bartlett's Test**

Kaiser-Meyer-Olkin Measure of Sampling Adequacy.		.749
Bartlett's Test of Sphericity	Approx. Chi-Square	897.402
	df	45
	Sig.	.000

(Source: Processing of the author's data)

**Table 4. Results of the EFA of organizational cohesion scale**

	Factor		
	1	2	3
EMCOH1	.842		
EMCOH3	.667		
EMCOH2	.603		
EMCOH4	.530		
OBCOH2		.926	
OBCOH3		.589	
OBCOH1		.574	
MAICOH3			.756
MAICOH4			.753
MAICOH2			.583

(Source: Processing of the author's data)

\* Results of confirmatory factor analysis (CFA) with all factors in the Organizational Culture Scale

At first time, CFA shows that the FUTORF variable is not statistically significant because the P value is greater than 0.05, so that, the variable will be removed from the model. The results of the second CFA indicates that Chi-square = 198,231; df = 155 (p = 0.011 < 0.05); Chi-square /df = 1.279 (< 3); TLI = 0.976; CFI = 0.980 (> 0.9); GFI = 0.943 > 0.8 and RMSEA = 0.03 < 0.08. Therefore, it is possible to conclude that the model is compatible with market data.

**Figure 2. Results of CFA of the organizational culture scale (standardized)**

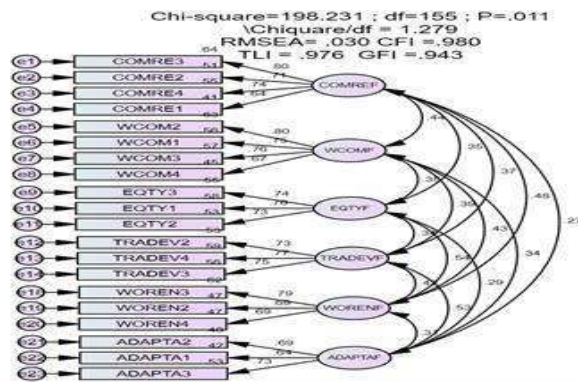

(Source: Processing of the author's data)

Differential test: The correlation coefficient between the component concepts and the standard deviation is less than 1 and the P-value is < 0.05, statistically significant (correlation coefficient for each pair of concepts different from 1 at 95% confidence). Therefore, research concepts achieve distinct value (table 5).

**Table 5. Results of differentiated valuation of components of the organizational culture scale**

			Estimate	S.E.	C.R.	P
COMREF	<-->	WCOMF	.169	.029	5.790	***
COMREF	<-->	EQTYF	.129	.028	4.612	***
COMREF	<-->	TRADEVF	.145	.030	4.800	***
COMREF	<-->	WORENF	.175	.029	5.975	***
COMREF	<-->	ADAPTAF	.085	.024	3.496	***
WCOMF	<-->	EQTYF	.122	.026	4.664	***
WCOMF	<-->	TRADEVF	.146	.029	5.113	***
WCOMF	<-->	WORENF	.147	.027	5.522	***
WCOMF	<-->	ADAPTAF	.101	.023	4.314	***
EQTYF	<-->	TRADEVF	.122	.028	4.398	***
EQTYF	<-->	WORENF	.178	.028	6.289	***
EQTYF	<-->	ADAPTAF	.084	.023	3.691	***
TRADEVF	<-->	WORENF	.146	.028	5.161	***
TRADEVF	<-->	ADAPTAF	.162	.028	5.820	***
WORENF	<-->	ADAPTAF	.089	.023	3.926	***

(Source: Processing of the author's data)

\* Results of confirmatory factor analysis (CFA) with all factors in the organizational cohesion scale

The results of CFA with the organizational cohesion scale indicates that Chi-square =86.05; df = 32 (p = 0.011 < 0.05); Chi-square /df = 2.689 (< 3) ; TLI = 0.912; CFI = 0.937 (> 0.9); GFI = 0.949 > 0.8 and RMSEA = 0.073 < 0.08. Therefore, it is possible to conclude that the model is compatible with market data.

**Figure 3. Confirmatory factor analysis of the organizational cohesion scale (Standardized)**

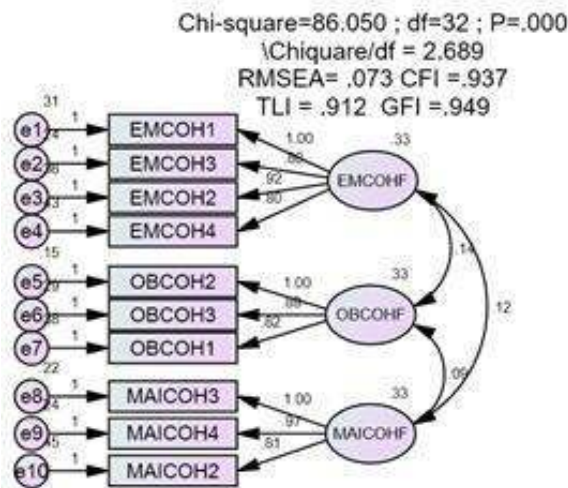

(Source: Processing of the author's data)

Check the differential value: The requirements of the system less than 1, check the union method and relative values between the pair contains the meaning of statistics (p-value <0.05). Because of this, it is possible to see the factors in the model of attainment of the model.

**Table 6. Results of differentiated valuation of components of the organizational cohesion scale**

			Estimate	S.E.	C.R.	P
EMCOHF	>	OBCOHF	.144	.027	5.334	***

			Estimate	S.E.	C.R.	P
EMCOHF	<--	MAICOHF	.124	.027	4.636	***
OBCOHF	<--	MAICOHF	.086	.025	3.443	***

(Source: Processing of the author's data)

**\*Analysis of SEM model**

The research uses structural equation model to assess relevance of the model and reevaluate relationships in the model. Firstly, the estimated results show that the relationships were statistically significant ( $p < 5\%$ ), except that the relationship between organizational culture and adaptability was not statistically significant. The adaptability variable is eliminated and the second SEM analysis indicates  $df = 516$ , Chi-square = 777.858 with  $p\text{-value} = 0.000 < 0.05$ , Chi-square /  $df = 1,507 < 3$ , CFI = 0.932, TLI = 0.926 ( $< 0.9$ ), GFI = 0.878  $< 0.8$ , RMSEA = 0.040  $< 0.08$ . Therefore, it is possible to conclude that the model achieves compatibility with market data (Figure 4).

**Figure 4. The final results of analyzing by SEM model (standardized)**

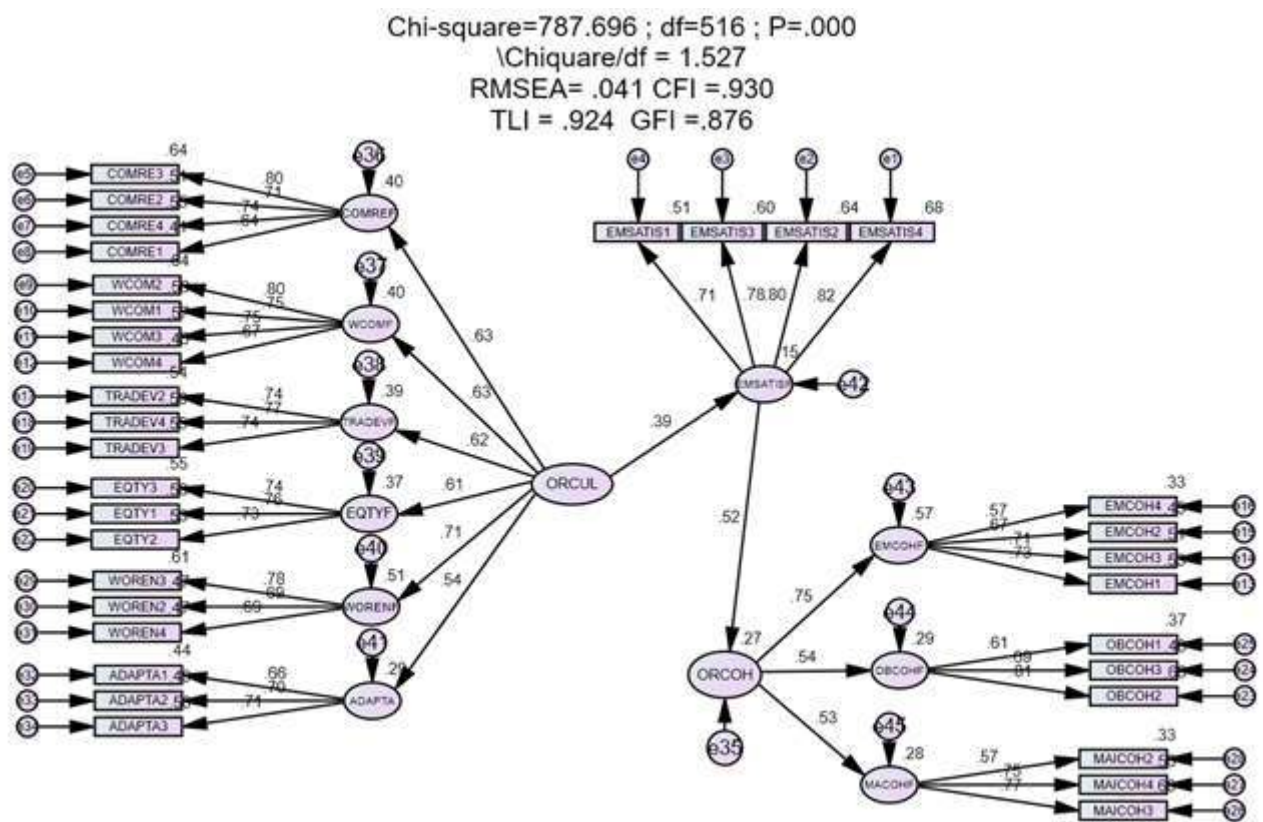

(Source: Processing of the author's data)

**\*Results of hypothesis test**

Hypotheses H1, H2 are accepted ( $p\text{-value} < 0.05$ ), meaning that organizational culture has a positively impact on employee's satisfaction. At the same time, employee's satisfaction also has a positively impact on employee's cohesion with the organization (Table 7).

**Table 7. Results of hypothesis test**

			Estimate (not standardized)	Estimate (standardized)	S.E.	C.R.	P	Results
EMSATISF	<---	ORCUL	0.644	0.391	0.130	4.947	**	Accepted
ORCOH	<---	EMSATISF	0.272	0.523	0.05	5.424	**	Accepted

(Source: Processing of the author's data)

\* Verified by Bootstrap with N = 500

With a repeatable sample of N = 500, the SEM analysis is re-conducted and the of estimated regression is re-calculated. The difference between the mean of estimates from the bootstrap and the initial estimates is called deviation. The absolute magnitude of this deviation is as small as possible, as statistically as possible. The results from the table show that the CR value is less than 2, so it can be said that the deviation is very small, not statistically significant at the 95% confidence level. Therefore, the estimates in the model can be trusted.

**Table 8. Estimate the model using Bootstrap with N = 500**

Parameter			SE	SE-SE	Mean	Bias	SE-Bias	CR
EMSATISF	<---	ORCUL	0.078	0.002	0.387	-0.004	0.003	-1.3333
ORCOH	<---	EMSATISF	0.087	0.003	0.526	0.003	0.004	0.75

(Source: Processing of the author's data)

\* Evaluate the impact of factors on the organizational cohesion

In the model, the employee's cohesion is affected directly by employee's satisfaction and indirectly affected by organizational culture. To assess the impact of factors on employee's cohesion, the author uses direct, indirect ratio, and identify impact factors to evaluate. The results show that the greatest influence was on employee's satisfaction ( $\lambda = 0.644$ ), followed by organizational culture ( $\lambda = 0.175$ ) (Table 9).

**Table 9. Impact of factors with the organizational cohesion**

Dependent variable	Impact	ORCUL	EMSATISF	ORCOH
EMSATISF	direct	.644	.000	.000
	indirect	.000	.000	.000
	total	.644	.000	.000
ORCOH	direct	.000	.272	.000
	indirect	.175	.000	.000
	total	.175	.272	.000

(Source: Processing of the author's data)

## 5. Conclusions

The results from the SEM model show that the organizational culture in tourism accommodation enterprises in Thanh Hoa is composed of five components: positive communication in the enterprise, training and development; commendation and recognition; working environment and equity and employees' cohesion in which employees' cohesion is also measured by three components: emotional cohesion, obligational cohesion and maintainal cohesion. The research results indicate that organizational culture has a strong impact on employee's satisfaction and employee's satisfaction impacts on employee's cohesion with the organization.

The research results suggest that, in order to increase the level of satisfaction and cohesion of employees, the tourism accommodation enterprises of Thanh Hoa need to increase positive communication in the enterprises. Tourism accommodation enterprises must evaluate fairly, objectively the results of their work and the fulfillment of the requirements, thereby reward appropriately the excellent individuals for their efforts in the workplace.

Enterprises need to create a comfortable working environment, hold parties, contests, or picnics to connect employees and give employees the fun, comfort after the stressful working days. Enterprises need to build a fair income distribution system, promotion policies and offer career advancement opportunities to all employees. On the other hand, human resource management and division managers should encourage employees express their training needs to find out the training objectives and hold courses suit the employees' needs.

The limitation of this research is that it is only carried out in tourism accommodation enterprises of Thanh Hoa, which have not yet been implemented in tour operators, food and beverages, travel transportation and tourism. On the other hand, the study just only considers the elements of organizational culture to employee's cohesion and satisfaction, while employees' satisfaction is influenced by many other factors (eg, nature of work, income, welfare, etc.). Therefore, the research on other factors affecting employee's satisfaction and cohesion should be carried out in the future.

## Reference

- [1] Aarons, G. A., & Sawitzky, A. C. (2006a). Organizational culture and climate and mental health provider attitudes toward evidence-based practice. *Psychology Service*, 3(1), 61–72.
- [2] Aarons, G. A., & Sawitzky, A. C. (2006b). Organizational climate partially mediates the effect of culture on work attitudes and staff turnover in mental health services. *Adm Policy Ment Health*, 33(3), 289–301.
- [3] Abraham, S. (2012). Job satisfaction as an antecedent to employee engagement. *SIES Journal of Management*, 8(2), 27–36.
- [4] Alfredo, R. M., Elfi, B., Hans, D. W., Bernardo, M. J., & Juan, C. P. (2009). Cross-lagged relationships between workplace bullying, job satisfaction and engagement: Two longitudinal studies. *An International Journal of Work, Health & Organisations*, 23(3), 225–243.
- [5] Ashkanasy, N. M., Wilderom, C. P. M., & Peterson, M. F. (2010). *Handbook of organizational culture and climate*. California: SAGE Publications.
- [6] Hair, J. F., Black, W. C., Babin, B. J., Anderson, R. E. & Tatham, R. L. (2006). *Multivariate data analysis* (6th edn). Pearson Prentice Hall.
- [7] Hair, J.F., Black,W.C., Tatham, R.L. & Anderson, R.E. (1998), *Multivariate Data Analysis*, Prentical - Hall International, Inc.
- [8] Harter, J. K, Schmidt, F. L., & Hayes, T. L. (2002). Business-unit-level relationship between employee satisfaction, employee engagement, and business outcomes: A meta-analysis. *Journal of Applied Psychology*, 87(2), 268–279.
- [9] Hoàng Trọng, & Chu Nguyễn Mộng Ngọc (2015). *Phân tích dữ liệu nghiên cứu với SPSS*. TP.HCM: NXB Hồng Đức.
- [10] Hunt S, Chonko L, Wood V, 1985. Organizational commitment and marketing. *Journal of Marketing*, 49: 112-126.
- [11] J.S. Adams (1963). Towards An Understanding of Inequality. *Journal of Abnormal and Normal Social Psychology*, 67 (1963) 422.
- [12] Meyer, J. P. & Allen, N. J. (1991). A three component conceptualization of organizational commitment. *Human Resources Management Review*, 1(1), 61– 89. Mowday, R. T., Porter, L. W., & Steers, R. M. (1982). *Employee organization linkages: The psychology of commitment, absenteeism, and turnover*. New York, NY: Academic Press.
- [13] P.E. Spector (1997). *Job Satisfaction: Application, Assessment, Causes, an Consequences*. Sage, Thousand Oaks, CA.
- [14] R.Kreiner, A. Kinicki (2007), *Organizational Behavior*. McGraw - Hill, New York.
- [15] Ricardo, R., & Jolly, J. (1997). Training of teams in the workplace. *S.A.M Advanced Management Journal*, 62(2), 4–21.
- [16] Ricardo, R., & Jolly, J. (2003). Organizational culture and teams. *Academy of Management Journal*, 32(5), 271–279.
- [17] Shah, I. A., Fakhr, Z., Ahmad, M. S., & Zaman, K. (2010). Measuring push, pull and personal factors affecting turnover intention: A case of university teachers in Pakistan. *Review of Economic and Business Studies*, 3(1), 167–192.
- [18] Shah, S. M. A., Jatoi, M. M., & Memon, M. S. (2012). The impact of organizational culture on the employees' job satisfaction & organizational commitment: A study of faculty members of private sector universities of Pakistan. *Interdisciplinary Journal of Contemporary Research in Business*, 3(11), 830–846.
- [19] SHRM. (2016). Employee job satisfaction and engagement: Revitalizing a changing workforce. Research report by a Society for Human Resource Management. Retrieved on 14/10/2016, from <https://www.shrm.org/hr-today/trends-and-forecasting/research-and-surveys/pages/jobsatisfaction-and-engagement-report-revitalizing-changing-workforce.aspx>
- [20] Truong Hoang Lam. (2012). The impact of corporate culture on employee commitment to the FPT Information System Company. Master thesis in economics, Nha Trang University.
- [21] Zain, Z. M., Ishak, R., & Ghani, E. K. (2009). The influence of corporate culture on organizational commitment: A study on a Malaysian listed company. *European Journal of Economics, Finance and Administrative Sciences*, 17, 16–26.

## APPENDIX A

### Appendix A1. Scale of organizational culture, satisfaction and employee's cohesion with the organization

Numerical order	Encode	Scale	Reference source
<b>Working communication (WCOMF)</b>			
1	WCOM1	Policy changes related to employees in the business are well informed	Ricardo and Jolly (2003); Zain et al. (2009); Shah et al. (2012); Truong Hoang Lam (2012); Expert interview.
2	WCOM2	The manager helps, supports staff when employees having trouble at work	
3	WCOM3	Provide enough information to do the job	
4	WCOM4	Encourage increased communication between colleagues and departments	
<b>Training and development (TRADEVF)</b>			
5	TRADEV1	Enterprises always create conditions for employees to attend training courses	Ricardo and Jolly (2003); Zain et al. (2009); Shah et al. (2012); Truong Hoang Lam (2012); Expert interview.
6	TRADEV2	Employees is trained the needed skills to do well job.	
7	TRADEV3	Take part in the training programs required by the job	
8	TRADEV4	Employees have many opportunities to develop and advance their work	
<b>Commendation and recognition (COMREF)</b>			
9	COMRE1	Enterprise implements the reward system as committed to employees	Ricardo and Jolly (2003); Zain et al. (2009); Expert interview
10	COMRE2	Employee performance is always assessed and recognized by the Enterprise	
11	COMRE3	Commendation and recognition based on quality of work	
12	COMRE4	Reward and recognition policies are clearly communicated to employees	
<b>Future orientation (FUTORF)</b>			
13	FUTOR1	Employees support the strategy, vision, goals of the Enterprise	Ricardo and Jolly (2003); Expert interview.
14	FUTOR2	Managers share information about the company's goals, visions, missions, strategies.	
15	FUTOR3	Enterprise has a clear development strategy	
16	FUTOR4	Managers always plan for changes that may affect the Enterprise situation of the Enterprise	
<b>Working Environment (WORENF)</b>			
17	WOREN1	Employees work professionally, seriously	Aarons and Sawitzky (2006a); Aarons and Sawitzky (2006b); Expert interview
18	WOREN2	Employees in business are sociable, willing to communicate with each other for work	
19	WOREN3	Staff support each other to complete the work	
20	WOREN4	Employees often chat, care, share work experience, experience life	
<b>Equity (EQTYF)</b>			
21	EQTY1	Wage and income distribution among business members is fair	Adam (1963); Truong Hoang Lam (2012); Expert interview.
22	EQTY2	The policies of recruitment, training, development, reward in the business is fair	
23	EQTY3	The salary or promotion process is clear and transparent	
24	EQTY4	Managers are consistent in implementing employee-related policies	
<b>Adaptability (ADAPTAF)</b>			
25	ADAPTA1	Employees will adapt in time if the Enterprise encounters serious problems.	Ginevicius and Vaitkunaite (2006)
26	ADAPTA2	Employees can adapt to new and changed Enterprise	

27	<b>ADAPTA3</b>	Employees will deal promptly with issues arising at work	
<b>Employee's satisfaction (EMSATISF)</b>			
28	EMSATIS1	Employees are satisfied with the requirements, rules and policies of the Enterprise	Kreitner and kinicki (2007); Aarons & Sanitzky, 2006a; Shaz et al., 2010); Expert interview.
29	EMSATIS2	Employees accept to work in the Enterprise	
30	EMSATIS3	Proud and introduced to friends about Enterprise	
31	EMSATIS4	Employees love the present job in enterprise.	
<b>Emotional cohesion (EMCOHF)</b>			
32	EMCOH1	Working for the enterprise is very important	Meyer and Allen (1991)
33	EMCOH2	Feel proud to be working for the enterprise	
34	EMCOH3	See that enterprise as a second home	
35	EMCOH4	The difficulty of the enterprise is also their problem	
<b>Obligational cohesion (OBOHF)</b>			
36	OBCOH1	You have to stick with the enterprise because you have invested a lot.	Meyer and Allen (1991)
37	OBCOH2	If you leave the enterprise, the career will be interrupted	
38	OBCOH3	It is difficult to find alternative jobs	
39	OBCOH4	Stick with the enterprise because of the relationship, personal interests	
<b>Maintainal cohesion (MAICOHF)</b>			
40	MAICOH1	Feel responsible for the enterprise	Meyer and Allen (1991)
41	MAICOH2	Do not leave the enterprise even if you find a better place	
42	MAICOH3	Leaving the business will affect colleagues, superiors	

Source: The author synthesized from the references

#### Appendix A2. Reliability analysis

Items	Scale Mean if Item Deleted	Scale Variance if Item Deleted	Corrected Item-Total Correlation	Cronbach's Alpha if Item Deleted
<b>WCOMF</b>	<b>Alpha = 0,829</b>			
WCOM1	12.41	3.861	.660	.783
WCOM2	12.39	3.725	.707	.762
WCOM3	12.48	3.617	.667	.780
WCOM4	12.43	3.919	.595	.812
<b>TRADEVF</b>	<b>Alpha = 0,791</b>			
TRADEV2	7.98	1.974	.631	.719
TRADEV3	7.82	1.994	.633	.715
TRADEV4	7.77	2.206	.638	.715
<b>COMREF</b>	<b>Alpha = 0,811</b>			
COMRE1	11.65	3.350	.570	.793
COMRE2	11.68	3.568	.639	.762
COMRE3	11.77	3.021	.688	.735
COMRE4	11.60	3.394	.635	.761
<b>FUTOR</b>	<b>Alpha = 0,743</b>			
FUTOR1	7.08	1.044	.610	.607
FUTOR2	7.07	1.246	.496	.737
FUTOR3	7.27	1.040	.604	.614
<b>WORENF</b>	<b>Alpha = 0,768</b>			
WOREN1	11.74	3.950	.502	.748
WOREN2	11.85	3.342	.594	.704
WOREN3	11.76	3.914	.650	.676
WOREN4	11.68	4.101	.558	.720
<b>EQTYF</b>	<b>Alpha = 0,783</b>			
EQTY1	7.86	2.149	.630	.704



EQTY2	8.04	1.791	.617	.723
EQTY3	7.99	2.031	.632	.696
<b>ADAPTA</b>	<b>Alpha = 0,730</b>			
ADAPTA1	8.02	1.689	.542	.656
ADAPTA2	7.98	1.818	.562	.634
ADAPTA3	7.91	1.675	.555	.640
<b>EMSATIS</b>	<b>Alpha = 0,859</b>			
EMSATIS1	11.97	4.222	.647	.844
EMSATIS2	11.95	3.960	.727	.812
EMSATIS3	11.96	4.208	.697	.824
EMSATIS4	11.97	3.849	.750	.801
<b>EMCOHF</b>	<b>Alpha = 0,760</b>			
EMCOH1	11.58	3.217	.629	.664
EMCOH2	11.58	3.416	.538	.715
EMCOH3	11.43	3.576	.595	.688
EMCOH4	11.66	3.547	.483	.745
<b>MAICOH</b>	<b>Alpha = 0,769</b>			
MAICOH2	7.65	1.738	.485	.739
MAICOH3	7.66	1.744	.597	.601
MAICOH4	7.63	1.737	.596	.601
<b>OBCOH</b>	<b>Alpha = 0,737</b>			
OBCOH1	8.00	1.621	.506	.722
OBCOH2	7.94	1.598	.656	.547
OBCOH3	8.00	1.655	.534	.684

Source: the author's calculation

# The Impacts of The 4<sup>th</sup> Industrial Revolution on Vietnamese Businesses

Mai Mai\*

Academy of Finance, No.1 Le Van Hien, Hanoi 100000, Vietnam

---

---

## ABSTRACT

The fourth industrial revolution (Industry 4.0) has increasingly become one of the most popularly discussed topics of manufacturing conferences, forums, and exhibitions. Impacts of the industry 4.0 have attracted academic and practical researchers over the world; however, the issues have not deeply understood in Vietnam. Most Vietnamese companies are small and medium enterprises (SMEs) have to suffer big challenges (and opportunities) from the industry 4.0. This article focuses on the impacts of the fourth industrial revolution on businesses in Vietnam. The businesses have to use the Internet-related technologies for the creation of value shown to customers, companies and society. The contribution of the article is mainly conceptual. The aim of this article is to synthesize the known theory and practices which are relevant to impacts of Industry 4.0 with the development of the Internet of things and show influence of industry 4.0 on business activities of Vietnamese companies.

**Keywords:** Impacts, industry 4.0, the fourth industrial revolution, Vietnamese businesses.

---

---

## 1. Introduction

The fourth industrial revolution develops over the world with increasing perfection in robotics production driving global industry towards robotics and automation, and causing changes in operation and production of businesses.

A survey conducted by VET (2017) through investigating 2,000 SMEs that are members of the Vietnam Association of Small and Medium Enterprises, show that 85 % of SMEs expressed their concern related to industry 4.0. Besides, 55 % SMEs say that industry 4.0 will significantly affect Vietnam's economy, 23 % of respondents believed the industry 4.0 will impact moderately, and 'no major influence' response accounts for 11 % of the respondents. However, another survey conducted at the CEO Forum held by VET (2017) revealed that 67 % of participants and current enterprises believe that Vietnam cannot catch up with this industrial revolution and only 33 % respondents show an optimistic about the prospects of keeping pace with it.

As can be seen, several Vietnamese enterprises have not recognized properly the concept of industry 4.0 and its significant effects. Therefore, the author desires to identify impacts of industry 4.0 on Vietnamese enterprises.

Research question: What are the impacts of the 4<sup>th</sup> industrial revolution on Vietnamese businesses?

The objective of this article is to determine what has been researched so far about the effects of Industry 4.0 on Vietnamese businesses. To achieve this objective, a comprehensive review of journal articles, edited volumes, books, conference papers, and other materials were reviewed. The contribution of the article is mainly conceptual.

## 2. Industry 4.0

Industry 4.0, with regard to artificial intelligence, big data, and connectivity, indicates the certainty of a new round of digital revolution.

According to Almada-Lobo (2016) and Lechler et al. (2015), industry 4.0 is predicted to strongly influence the complete transformation of industry because it represents progress on three fields, digitization of production, automation and automatic data interchange.

1. Digitization of production—information systems for management and production planning;

\* Corresponding author. Tel.: +841699424288.  
E-mail address: maimai@hvtc.edu.vn

2. Automation—systems for data acquisition from the production lines and using machines;
3. Automatic Data Interchange - Linking manufacturing sites in a comprehensive supply chain

The four key components of Industry 4.0: Cyber- physical systems (connections between the real and virtual world), the IoT (Internet of Things), the IoS (Internet of Services), and the smart factory, are explained in **Table 1** as below:

**Table 1. Key components of industry 4.0**

<b>Concepts</b>	<b>Explanation</b>
Cyber – physical systems	“Systems will integrate computation, networking, and physical processes. Embedded computers and networks will monitor and control the physical processes, with feedback loops where physical processes affect computations and vice versa. An example is control of vital human functions that allow urgent health care through mobile applications, sensors in clothing, and sensors and surveillance cameras in flats” (Roblek, et al., 2016).
The IoT (the Internet of Things)	The IoT like radio-frequency identification sensors that will send storage, processing, and analysis information, and smartphones that interact with each other and cooperate with smart components (Dutton, 2014).
The IoS (the Internet of Services)	“Internet of service allows provision of services via the Internet. IoS consists of participants, infrastructure services, business models and services themselves. Services are offered and merged into value-added services from different vendors, and communications via various communication channels. This approach allows different variants of distribution in the value chain” (Slamkova et al, 2015).
Smart factory	“The smart factory will be more flexible and dynamic. Manufacturing will be equipped with sensors, actors, and autonomous systems. Machines and equipment will have the ability to improve processes through self-optimization and autonomous decision making.” (Roblek, et al., 2016).

Source: (Dutton, 2014, Slamkova et al., 2015 and Roblek, et al., 2016)

### 3. The impacts of industry 4.0 on Vietnamese businesses

Jay Lee and Edzel Lapira (2014) stated that a predictive manufacturing system will be established in industry 4.0. It provides machines and systems with “self-aware” capabilities, thereby giving greater transparency to users and ultimately avoiding potential problems concerning productivity efficiency and safety. Some benefits of the predictive manufacturing systems are following:

(1) Cost reduction: By knowing the actual condition of the manufacturing assets, maintenance activities can be provided with more accuracy. In other word, it is called “just – in – time maintenance” system.

(2) Product quality improvement: Degradation patterns and near real - time machine condition estimates can be integrated with process controls, so product quality is assured while accounting for equipment or system drifts over time.

(3) Operation efficiency: Production and maintenance supervisors can prudently make a better operation plan, bringing about maximizing equipment availability on time.

Second, a transformation of the organizations and its processes. Technology is setting a new tempo with high speed. Companies will have to gain knowledge that will enable the development of “digital thinking” and will need highly-qualified employees in order to manage the process in a new way. Those who failed to read and analyse data, and determine their nature independently will be slower than competitors. Employees will also require more autonomy and be allowed independent decision making (Scheer, 2012).

Third, industry 4.0 changes the way businesses interact with customers

The IoT is a new expression of the relationship between customers and producers. It is suggested that the systems may well be a combination of robotic-like tools such as personal intelligent agents, for example Cortana, Siri, Viv, Google Now and others, with the IoT (Vaidyanathan & Aggarwal, 2015). Furthermore, an increasing awareness of customers leads to the importance of quality and reliability of the acquired and given information and technical condition of the products. This will affect the accumulation and analysis of information in real time and, consequently, impact on coming guidelines of value creation for the customers (Espejo & Dominici, 2016). This evolution of technology, which allows the consumer to access huge resources of marketing information, results to streamlined purchasing and tracking of goods and services. This age of marketing which utilizes functions of the IoT and IoS has

become the new tools used in customer relationship management (Marolt et al., 2015). Moreover, customers prefer to become a participant of the manufacturing process for their individualized products and join to direct consumer experience process.

Fourth, industries will be restructured in Vietnam (National Bureau of Technology and Information, 2016). New technologies are applied in marketing and manufacture which may phase out the existing industrial value chain (such as Uber, Grab). Several industries could disappear and certain new industries be created. If companies fail to research, develop and innovate, extinction may emerge from the fierce competition. This reality will consequently force companies to keep up with the fast pace of innovation by improving their overall approach to business.

Finally, companies will lag behind competitors if the companies do not invest in innovation. To keep a competitive advantage, enterprises will have to provide custom designs and products that quickly adapt to customer's satisfaction. Take advantage of IoT and other technologies to digitize the whole process and shorten time to appear on markets. In addition, employees can work through the internet; semi-automatic robot will be used alongside manpower to increase productivity, assure quality and save time.

Moreover, industry 4.0 facilitates start-ups to develop. Industry 4.0 makes a change for new ideas to meet consumer demand. Digital marketing harnesses small business approach to a large number of customers with low cost.

#### 4. Methodology

The purpose of this article is to determine what has been researched so far about the effects of Industry 4.0 on Vietnamese businesses. To achieve this objective, a comprehensive review of journal articles, edited volumes, books, conference papers, and other materials were reviewed. According to Roblek et al. (2013), industry 4.0 is still in a conceptual state and intends to include a dynamic technological concept involving three components, physical technology, digital technology and biological technology. A comprehensive bibliography of the academic literature on manufacturing, customer behaviours and Industry 4.0 are provided, based on the relevant journal articles included and analysed.

#### 5. Conclusion

This article shows key impacts of the fourth industrial revolution on Vietnamese businesses, including a benefit improvement (such as cost reduction, operation efficiency and product quality development), a transformation of the organizations and its processes, the industries to be restructured in Vietnam, the companies that will likely lag behind competitors if the companies do not invest in innovation, and other impacts. A limitation of the article is that no survey was made though the intention has been to review existing literature and assess positions on the basis thereof. Primary data should be collected and analysed in further studies to create a more persuasive result.

#### References

- [1] Almada-Lobo, F. (2016). The Industry 4.0 revolution and the future of manufacturing execution systems (MES). *Journal of Innovation Management*, 3, 16-21.
- [2] Dutton, H. W. (2014). Putting things to work: Social and policy challenges for the Internet of things. *Info*, 16, 1-21. DOI: 10.1108/info-09-2013-0047.
- [3] Espejo, R., & Dominici, G. (2016). Cybernetics of value cocreation for product development. *Systems Research and Behavioral Science*. doi:10.1002/sres.2392.
- [4] Jay Lee and Edzel Lapira (2014). Recent advances and Trends in Predictive Manufacturing in Industry 4.0 Environment. *Asset Condition Management*.
- [5] Lechler, A., Schlechtendahl, J., Keinert, M., Kretschmer, F., & Verl, A. (2015). Making existing production systems Industry 4.0-ready. *Production Engineering*, 9, 143-148. DOI: 10.1007/s11740-014-0586-3.
- [6] Marolt, M., Pucihar, A., & Zimmermann, D. H. (2015). Social CRM adoption and its impact on performance outcomes: A literature review. *Organizacija*, 48, 260-271. DOI:10.1515/orga2015-0022.
- [7] National Bureau of Technology and Information (2016). Cuoc Tong Luan Cach Mang Cong Nghiep 4.0. Retrieved on July 30<sup>th</sup> 2017, from <http://dost.danang.gov.vn/documents/11328/196705/T%E1%BB%95ng+lu%E1%BA%ADn+Cu%E1%BB%99c+CMCN+1%E1%BA%A7n+4.pdf/f75a7d0d-5143-4549-b7ac-ddc94889b1cb>
- [8] Roblek, V., Pejić Bach, M., Meško, M., & Bertancelj, A. (2013). The impact of social media to value added. *Kybernetes*, 42, 554-568. doi:10.1108/K-01-2013-0014
- [9] Roblek, V., Meško, M., and Krapež, A. (2016). A Complex View of Industry 4.0. *SAGE Journal*, 1-11. DOI: 10.1177/2158244016653987.
- [10] Scheer, A. W. (2012). Industrial Revolution 4.0 is associated with far-reaching organizational consequences. *Information Management & Consulting*, 3, 10-11.
- [11] Slamkova et al. (2015). Industry 4.0 – New era of manufacturing. Retrieved on July 30<sup>th</sup> 2017, from

[https://www.researchgate.net/profile/Jozef\\_Hercko/publication/285597327\\_INDUSTRY\\_40\\_-\\_NEW\\_ERA\\_OF\\_MANUFACTURING/links/56f1a41b08ae1cb29a3d1688.pdf?origin=publication\\_list](https://www.researchgate.net/profile/Jozef_Hercko/publication/285597327_INDUSTRY_40_-_NEW_ERA_OF_MANUFACTURING/links/56f1a41b08ae1cb29a3d1688.pdf?origin=publication_list)

- [12] Vaidyanathan, R., & Aggarwal, P. (2015). The impact of shopping agents on small business E-commerce strategy. *Journal of Small Business Strategy*, 13, 62-79.
- [13] VET (2017). Vietnam urged to prepare for the 4th industrial revolution. Retrieved on July 30<sup>th</sup> 2017, from <http://english.vietnamnet.vn/fms/business/178561/vietnam-urged-to-prepare-for-the-4th-industrial-revolution.html>

# Finance – Growth Nexus in Developing Countries: Threshold or Not

Bui Thanh Trung<sup>a\*</sup>, Nguyen Thi Thanh Van<sup>b</sup>, Le Thi Thuy Hang<sup>b</sup>

<sup>a</sup> School of Public Finance, University of Economics Ho Chi Minh City, 196 Tran Quang Khai street, Tan Dinh ward, district 1, Ho Chi Minh city, Vietnam, postcode: 700900

<sup>b</sup>Faculty of Finance-Banking, University of Finance and Marketing, 2/4 Tran Xuan Soan street, Tan Thuan Tay ward, district 7, Ho Chi Minh City

---

---

## ABSTRACT

The evidence that financial development has positive contribution to the process of economic growth has been well established. However, recent studies have shown that the nexus is more likely to be non-linear rather than linear, meaning that financial development could be too much and become a drag on economic growth. The paper re-investigates the linkage but unlike previous studies, the focus is on only a group of developing countries. A panel threshold regression was employed to analyze a sample of 53 less developed economies over 1981 to 2013. The empirical results indicated that the threshold effect of financial development on economic growth emerges only with government consumption and, in a broad sense, the latter has no significant effect on the former in developing countries. On the other hand, in developing countries, other factors such as trade openness and capital accumulation are more important in boosting the economy than financial development.

**Keywords:** threshold, financial development, finance, growth, developing countries

---

---

## 1. Introduction

Financial development, which involves improvements in various functions of financial system such as pooling and allocating funds, generating liquidity, or sharing risk (King & Levine, 1993; Levine and alii, 2000), has been widely accepted as an important determinant of economic growth (Anwar & Nguyen, 2011; Bojanic, 2012), especially in developing countries (Christopoulos & Tsionas, 2004; Hassan and alii, 2011). While many researchers believe that a higher development of financial sector increases economic efficiency and thus leads to higher economic growth rate, others argue that over-development of the former may hurt the latter. To put it differently, aggressive expansion of financial sector beyond a threshold has negative effect on the process of growth. Such a belief has been strongly justified by struggling experience of many economies, especially developing ones, in the recent episode of global financial crisis.

Recent empirical evidence, which mostly used a large sample of developed and developing countries, has shown that the positive effect of financial development on economic growth depends to great extent on its level of development (Arcand and alii, 2012; Cecchetti & Kharroubi, 2012; Rioja & Valev, 2004; Shen & Lee, 2006). In particular, when the financial sector is over-expanded, it competes with the real sector for important resources such as skilled workers. In addition to this, a larger financial sector may raise problem of “too big to fail”, whereby financial intermediaries tend to take on excessive risk in credit allocation and increase the vulnerability of not only the financial system but also the whole economy.

Although the presence of the convexity in the nexus between finance and growth is of essence for policy design, such a consensus has remained unexplored to certain extent in the context of a homogenous group of developing countries. On one hand, since those countries have young and low-developed financial system, the conclusion that finance is overdeveloped may lose it ground. On the other hand, “too much finance” may emerge through other mechanisms. For instance, the impact of finance on growth could vary according to the level of income (Deidda & Fattouh, 2002; Gaytan & Rancière, 2004; Huang & Lin, 2009) or inflation (C. Lee & Wong, 2005; Rousseau &

\* Corresponding author. Tel.: +84909608518  
E-mail address: trungbt@ueh.edu.vn

Wachtel, 2002; Rousseau & Yilmazkuday, 2009).

This paper is going to get further insight on how economic variables such as government consumption, degree of trade openness, inflation as well as financial development cause a shift in the influence of financial development on economic growth. The study investigates a sample of 53 developing countries rather than a world-wide sample. Such a narrow focus is essential because recent evidence about an inverse-U curved interaction between finance and growth may not be found in economies of which financial system has lower level of development. In those countries, financial development may be insignificant or negative effect on economic growth. Nevertheless, the effect may not change with respect to the development of the former but with the movement of other economic indicators.

The rest of the paper is structured as follows. Section 2 reviews the development of knowledge about the nexus between finance and growth and discuss how the latter has nonlinear impact on the latter. Section 3 shows the methodology and data. Section 4 discusses empirical results. And, Section 5 concludes the paper.

## 2. Literature review

The idea that financial development can foster economic growth has been well established since the seminal study of Schumpeter (1911). In 1990s, a large number of studies investigated their causal linkage, which aimed to answer the question whether improvement in the former would lead to an increase in the latter. Among various views, that financial development plays a neutral role in the process of economic growth has lost its ground (Graff & Karmann, 2006). In reverse, that financial development could boost economic growth becomes the main strand of study. Along this line, King and Levine (1993) was one of the first studies provided support for the predictable power of financial development in the process of economic growth, especially in the long run. Levine and Zervos (1998) added more evidence about the positive role of financial development by using its market-based measures.

There are several justifications for the positive contribution of financial development to economic growth. To begin with, financial development usually comes along with greater quantity, and arguably higher quality of, financial products and services and such a volume effect offers economic agents greater access to financial resources and thus promotes economic activities (McKinnon, 1973; Shaw, 1973). The second effect involves a substantial decline in the cost of trading and financing brought out by either financial innovation or diversification opportunities. As pointed by Graff and Karmann (2006), monetization, which refers to the introduction of additional means of payment, can stimulate growth at earliest stages of financial development. Last but not least, financial development also contributes to growth by improving productivity, which is attributable to the effective transfer of funds to more productive uses (Goldsmith, 1969), the absorption of technology transfers, managerial expertise, and capital embodied in foreign direct investment (Adeniyi and alii, 2012), or the supply of insurance or hedging instruments. The allocation effect explains how financial development holds a distinctive role in boosting economic activities (Graff & Karmann, 2006).

A large number of empirical studies, which used a variety of techniques such as cross-section (King & Levine, 1993), panel (Calderón & Liu, 2003), time-series (Sehrawat & Giri, 2015; Shan and alii, 2001), or their combination (Al-Yousif, 2002; Levine and alii, 2000), have supported a positive and linear interaction between finance and growth. Al-Yousif (2002) used both time-series and panel approaches to investigate the nexus in 30 developing countries over 1970 to 1999. Accordingly, the evidence that financial development was mutually related to economic growth was dominant. Calderón and Liu (2003) found similar results when investigating an even larger sample of 109 developing and developed countries from 1960 to 1994. By mean of Geweke decomposition test, they noted that the causal relationship was more pronounced in the group of less developed economies. On the contrary, Sehrawat and Giri (2015) used time-series tests such as ARDL and Cointegration and concluded the positive economic contribution of financial development in India over the period 1982-2012, which was robust to either bank-based or market-based measures. Despite of differences in time and space of research, by and large these studies indicated that the more financial development the larger the economy.

However, there has been substantial doubt about the robustness of the linear contribution of financial development to economic growth. The recent episode of financial crisis has indicated that a cumbersome financial system is highly likely to be detrimental to economic activities (Arcand and alii, 2012; Law & Singh, 2014). This is owing to the fact that a large financial system bears a higher likelihood of financial turmoil. As argued by Rajan (2005), size and risk appetite of financial sector are procyclical, meaning that financial sector may consume substantial amount of risk in its development during time an overheating economy and thus increase the exposure of the whole economy.

It should be noted here that the idea of too much finance has been found in several studies published before the crisis. For instance, Rioja and Valev (2004) documented an inverse-U shaped interaction between finance and growth, whereby the growth-enhancing effect of the former was strongest in regions whose financial sector was at the middle level of development, weaker in more developed regions, and uncertain in low regions. Shen and Lee (2006) noted that the convexity was sensitive to measures of financial development. In particular, the convexity was more pronounced with the evolution of stock market development than banking development. Their results also indicated that stock market development had positive contribution whereas that of banking development might be negative. Similarly, Graff and Karmann (2006) found that financial development contributed less to growth when it failed to keep up with or exceed the expansion of the economy. In later studies, Arcand and alii (2012) and Cecchetti and Kharroubi (2012)

documented a threshold of about 100 percent of GDP beyond which an increase in credit to individuals and firms could put a damper on economic growth.

The evidence that there are three stages in which financial development has distinctive role on the process of economic growth can be explained by a variety of institutional factors. Firstly, the learning-by-doing effect offers a plausible explanation for the ambiguous contribution of finance to growth in its earliest stages of development, but positive in the latter stages. Financial development may be an important driver of growth but that role needs the sophistication of financial services and good practice of regulation, of which the establishment requires a considerable amount of time and learning effort (J. Lee, 1996). Meanwhile, lacking a good institutional and regulatory framework may restrict the growth-enhancing effect of an expansion in the financial system (Arcand and alii, 2012) and, in economies with poor institutions, financial development may have no significant effect on economic growth (P. Demetriades & Hook Law, 2006).

Financial development may also put a damper on economic growth due to the existence of diminishing return effect, whereby financial intermediaries become too large and cumbersome to maintain effective operations. Also, a rapid expansion of the financial sector can make the whole economy worse off rather than better off because it competes with the economic sector for skilled workforce as well as other essential resources (Cecchetti & Kharroubi, 2012). During an overheating economy, banks face difficulty in finding worthy borrowers and nominal profit commitments push them to take more risk through, for instance, purchasing risky assets or easing conditions of granting loans. The surge of risk tolerance eventually increases the exposure of the financial sector as well as the whole economy to external shocks. In particular, an excess of financial development may lead to high inflation and worsen the health of the banking system (Rousseau & Wachtel, 2011).

Overall, the review so far has shown that most studies employed a large panel consisting of both developed and developing countries, which is an important condition for the emerge of an inverse U-shaped interaction between financial development and economic growth. If, however, considered a dataset of only developing countries, the idea of too much finance may not emerge. One reason is that the financial system of these countries has a short history and low level of development. Another reason is that financial sector is a highly skill-intensive industry, its development could lead to a strong competition with the non-financial sector for highly-educated employees. In the context of less developed countries, this competition could be harsh and thus financial development could have insignificant or even negative contribution to economic growth (Deidda, 2006).

Although the idea of too much finance does not emerge with the level of financial development, its validity still remains but in the sense that it exceeds the pace of economic expansion. This means that financial development is low but it is too much for the economy given its prevailing conditions. As suggested by Jude (2010), not only financial development but also economic indicators can be sources of the non-linearity of the finance-growth nexus. Along this line, Deidda and Fattouh (2002) provided evidence of an income threshold when applying a panel threshold model (Hansen, 1999) to a large sample of 119 countries over the years from 1960 to 1989. The results supported the positive impact of financial development on growth only in high-income countries.

Besides, financial development is detrimental to economic growth when inflation exceeds a threshold ranging from 13 to 25 percent and disinflation is necessary to increase its growth-improving effect (Rousseau & Wachtel, 2002). Broadly, most of less developed economies have not adopted inflation targeting for monetary policy and many of them have experienced unstable periods with high inflation. Consequently, inflation is a crucial consideration when examining the finance-growth nexus. It may affect the finance-growth nexus in many different ways. Firstly, pressure of increased prices could deteriorate the predictability of information, causing difficulty in valuing assets, income, and future cash flows, and thus increasing the uncertainty of capital budgeting planning and ineffective allocation of funds. For that reason, banks are less willing to provide credit for long-term expenditures (Rousseau & Wachtel, 2002), resulting in a reduction in bank lending and financial market activities (Boyd and alii, 1996) and ultimately a fall in economic activities. Moreover, the expectation of high inflation could reduce the attractiveness of financial assets, which further lower the level of financial development. Furthermore, high inflation also prevents the process of financial integration due to inherited risks such as a devaluation or speculative attack (Rousseau & Wachtel, 2002). In summary, high inflation may influences the finance - growth nexus indirectly through an increase in macroeconomic instability or directly through a fall in the development of the financial sector (Rousseau & Wachtel, 2002).

Apart from high inflation, developing countries may also concern the influence of government consumption on the growth effect of financial development since a larger proportion of national resources is required to finance higher level of public consumption. Such an eviction effect puts a damper on economic growth because it causes a rise in the marginal cost of raising additional resources for both existing and further investments. However, P. O. Demetriades and Rousseau (2010) argued that the crowd-out effect between financial development and government consumption was stronger in the short run but in the long run, both supported each other.

Over the past decades, developing countries have gradually opened their borders and established trade relations with other countries. A greater degree of openness not only creates more opportunities for private investments but also expands the pool of funds for those investments. According to Jude (2010), firms in open economies with a well-functioned financial system have greater accessibility to foreign capital and thus show less sensitivity to the development of domestic financial system. However, it is still unclear about the effect of finance on growth in group of



economies with weak financial systems, just like those of developing countries. In such a case, economic agents can cope with the lack of risk-hedging instruments and thus become more vulnerable to international shocks. To this end, greater degree of openness can be detrimental to the growth-enhancing effect of financial development.

### 3. Methodology and data

#### 3.1. Threshold estimation

Advanced on Hansen (1999) approach, we specify a one-threshold model with a dynamic feature as follow:

$$y_{it} = \mu_{it} + \alpha y_{i,t-1} + \beta_1 f_{it} \Gamma(q_{it} < \gamma) + \beta_2 f_{it} \Gamma(q_{it} \geq \gamma) + x_{it} + \varepsilon_{it} \quad (1)$$

where  $y_{it}$  indicates real growth rate of country  $i$  at period  $t$ .  $f$  is the vector of financial development indicators.  $X$  is the control variable vector.

The transition variable  $q$  is used to determine threshold at which financial development has different impact on economic growth. The parameter  $\gamma$  is a specific threshold identified from the transition variable. The indicator function  $\Gamma(q_{it} < \gamma)$  is as follows:

$$\Gamma(q_{it} < \gamma) = \begin{cases} 1 & \text{if } q_{it} < \gamma \\ 0 & \text{otherwise} \end{cases}$$

The choice of a panel threshold model is essential because it allows coefficients in the finance-growth equation to change. As developing countries have undergone several financial reforms which may cause structural shifts in the linkage between finance and growth, that financial development coefficients are time-variant is highly likely.

#### 3.2. Test for threshold

In this paper, the test for a threshold effect is similar to the reject that coefficients are different between regimes. In other words, the null of no threshold would be as follows:

$$H_0 : \beta_1 = \beta_2$$

As suggested by Hansen (1999), we compute F-statistic (see Equation (2(2)) and its relevant p value by using a bootstrap process.

$$F(\gamma) = \frac{(SSE_R - SSE_U(\hat{\gamma})) / 1}{SSE_U(\hat{\gamma}) / n(T-1)} = \frac{SSE_R - SSE_U(\hat{\gamma})}{\hat{\sigma}^2} \quad (2)$$

#### 3.3. Data description

The dataset includes 53 developing countries over the period 1977-2016. the study uses 5-year moving average of different series, which is essential to reduce the effect of business cycle.

In line with the existing literature, we use real GDP per capita ( $Y$ ) as a measure of economic growth. Financial development is measured through several indicators. The first one is the ratio of money supply M2 to nominal GDP, which is denoted as LIQ. The ratio has been extensively used in previous studies (See, for instance, Al-Yousif, 2002; King & Levine, 1993; McKinnon, 1973; Shaw, 1973; and many others) to measure how large the financial sector is when compared with the economic sector. An increasing in LIQ implies higher significance of financial system in the economy.

Apart from LIQ, other common proxies are domestic credit to private sector provided by banks or the whole financial system, expressed as percentage of GDP and hereafter denoted as BANK and PRC. These measures indicate the volume of funds channelled to individuals and firms, which is the basic function of financial system. As BANK and PRC increase, private sector has greater financial accessibility, which helps them make larger capital expenditure.

In this paper, control variables of growth such as government consumption, trade openness, and inflation take another role as transition variables. These variables are also expressed as percentage of GDP. Their denotations are GOV, OPEN, and INF respectively.

### 4. Empirical results and discussion

The threshold test rejects the null hypothesis of a linear interaction between financial development and economic

growth for only the ratio of government consumption over GDP, which is in line with the literature that a larger government spending may alter the effect of the latter on the former (see Table 1). The result implies the presence of the eviction effect whereby government consumption crowds out the growth-enhancing effect of the expansion of credit to private investment. Interestingly, although the non-linearity also emerges when liquidity takes the role of regime-changing variable, the coefficients are not statistically significant.

Nevertheless, the threshold test cannot reject the null when measures of financial development act as transition variables. It suggests that there is only one rather than multiple equilibrium in the relationship between finance and growth. This finding is contrary to those found by Rioja and Valev (2004), Shen and Lee (2006), Graff and Karmann (2006), Arcand and alii (2012), Cecchetti and Kharroubi (2012) [and many others](#). Such a disparity is mainly attributable to the choice of a more homogeneous sample in this paper whereby only a group of developing countries is investigated. Consequently, the paper goes back to present linear estimations rather than threshold estimations in the last three columns of the Table 1. In line with previous findings, financial development has insignificant influence on economic growth in case of developing countries.

Turning to the negativity of financial coefficients, there are several implications. Firstly, financial development plays a trivial role in promoting economic growth in the context of developing countries. A plausible explanation is that the development of financial system has costs itself, for instance, expenditures on infrastructure and regular maintenance. And, in certain cases, that the efficiency gained from a higher level of financial development is not sufficient to offset the costs would lead to a reduction in economic growth (Stiglitz, 1993). Since the expansion of financial development is on the expense of other sector in developing country, the emphasis of these countries on the financial sector as an important stimulus in the process of economic growth should require a great caution.

Secondly, since the magnitude of the effect of financial development on economic growth is conditional on the quality of institutional factors, the insignificant contribution of financial development has two important suggestions. One, developing countries should undertake sophisticated reforms to improve the efficiency of not only various functions of financial system but also the regulatory frameworks. Two, although institutional improvement is essential, its establishment and success requires a sluggish process of trial and error (J. Lee, 1996). While waiting for setting up necessary conditions for deriving economic efficiency from higher level of financial development, developing countries should pay more attention to other drivers of growth such as capital accumulation or trade openness.

**Table 1. The estimation of the finance-growth nexus in developing countries**

	(1) GOV: LIQ	(2) GOV: PRC	(3) LIQ	(4) BANK	(5) PRC
Growth(-1)	0.982*** (0.006)	0.985*** (0.006)	0.998*** (0.002)	0.998*** (0.002)	0.999*** (0.002)
Capital	0.023*** (0.005)	0.024*** (0.005)	0.028*** (0.004)	0.028*** (0.004)	0.028*** (0.004)
Human	0.029* (0.017)	0.030* (0.016)	0.034* (0.018)	0.034* (0.017)	0.034* (0.017)
Trade open	0.020*** (0.006)	0.021*** (0.006)	0.011** (0.004)	0.012*** (0.004)	0.012*** (0.004)
Inflation	-0.000*** (0.000)	-0.000*** (0.000)	-0.000*** (0.000)	-0.000*** (0.000)	-0.000*** (0.000)
Government consumption	-0.024** (0.010)	-0.022** (0.010)	-0.028*** (0.008)	-0.027*** (0.008)	-0.027*** (0.008)
Finance			-0.002 (0.004)	-0.003 (0.003)	-0.004 (0.003)
Regime1	0.001 (0.004)	-0.002 (0.003)			
Regime2	-0.003 (0.005)	-0.007* (0.004)			

Constant	0.075 (0.057)	0.053 (0.056)	-0.011 (0.027)	-0.018 (0.027)	-0.021 (0.027)
Threshold1	18.399	18.399			
F-statistic	37.764	45.533			
p-value	0.000	0.000			

Notes: In this paper, there are many transitions variables such as three indicators of financial development, government consumption, inflation, and trade openness. There are twelve corresponding specifications, each of which is tested against the hypothesis of two and then one threshold. If there is no threshold, the linear estimation is presented. The above table reports estimation results when the threshold is statistically significant.

In a broader sense, our results are contrary to Jude (2010) finding about the effect of trade open, inflation, and financial development indicators on the nonlinear relationship between finance and growth. This is mainly attributable to the more focus of the study sample, which consists of only developing countries rather than a large pool of both developing and developed ones.

## 5. Conclusion

This paper revealed the crowd-out effect of government consumption on the finance-growth linkage when analysing a large panel of 53 developing countries from 1981 to 2013. The threshold of government consumption is approximately 18.4% percent of GDP, beyond which the effect of financial development on economic growth becomes negative. However, at lower level of government consumption, financial development has no statistically significant impact on economic activities.

Another interesting finding is that although the threshold is statistically significant when liquidity is used as regime-dependent variable, the coefficients are not statistically significant. In other word, an increase in the volume of financial services does not stimulate economic growth.

In a broad sense, financial development is not an important driver of economic growth in the context of developing countries. Possible explanations are the learning-by-doing effect and the competing effect. Therefore, improvements in the practice of financial regulation as well as the sophistication of financial services are essential to ripe the benefit of greater availability of financial services.

From the perspective of policy design, our findings suggest that while financial development is not an important stimulus for the process of economic growth in developing economies, they can still rely on other drivers such as trade openness or the accumulation of both physical and human capital. However, this does not mean that less developed economies should put less emphasis on the development of financial sector but means that they should focus more on institutional factors, which are essential to gain efficiency benefits from higher level of financial development.

## References

- [1] Adeniyi, O., Omisakin, O., Egwaikhide, F. O., & Oyinlola, A. (2012). Foreign direct investment, economic growth and financial sector development in small open developing economies. *Economic Analysis and Policy*, 42(1), 105-127.
- [2] Al-Yousif, Y. K. (2002). Financial development and economic growth: another look at the evidence from developing countries. *Review of Financial Economics*, 11(2), 131-150.
- [3] Anwar, S., & Nguyen, L. P. (2011). Financial development and economic growth in Vietnam. *Journal of Economics and Finance*, 35(3), 348-360.
- [4] Arcand, J.-L., Berkes, E., & Panizza, U. (2012). *Too Much Finance?* (ed.): International Monetary Fund.
- [5] Bojanic, A. N. (2012). The impact of financial development and trade on the economic growth of Bolivia. *Journal of Applied Economics*, 15(1), 51-70.
- [6] Boyd, J. H., Levine, R. E., & Smith, B. D. (1996). *Inflation and financial market performance* (ed. Vol. 9617).
- [7] Calderón, C., & Liu, L. (2003). The direction of causality between financial development and economic growth. *Journal of Development Economics*, 72(1), 321-334.
- [8] Cecchetti, S. G., & Kharroubi, E. (2012). Reassessing the impact of finance on growth.
- [9] Christopoulos, D. K., & Tsionas, E. G. (2004). Financial development and economic growth: evidence from panel unit root and cointegration tests. *Journal of Development Economics*, 73(1), 55-74.
- [10] Deidda, L. (2006). Interaction between economic and financial development. *Journal of Monetary Economics*, 53(2), 233-248.
- [11] Deidda, L., & Fattouh, B. (2002). Non-linearity between finance and growth. *Economics Letters*, 74(3), 339-345.
- [12] Demetriades, P., & Hook Law, S. (2006). Finance, institutions and economic development. *International Journal of Finance & Economics*, 11(3), 245-260.
- [13] Demetriades, P. O., & Rousseau, P. L. (2010). *Government, Trade Openness and Financial Development*. NBER

working paper.

- [14] Gaytan, A., & Rancière, R. G. (2004). Wealth, financial intermediation and growth. Available at SSRN 860925.
- [15] Goldsmith, R. W. (1969). Financial structure and development.
- [16] Graff, M., & Karmann, A. (2006). What determines the finance-growth nexus? Empirical evidence for threshold models. *Journal of Economics*, 87(2), 127-157.
- [17] Hansen, B. E. (1999). Threshold effects in non-dynamic panels: Estimation, testing, and inference. *Journal of econometrics*, 93(2), 345-368.
- [18] Hassan, M. K., Sanchez, B., & Yu, J.-S. (2011). Financial development and economic growth: New evidence from panel data. *The Quarterly Review of economics and finance*, 51(1), 88-104.
- [19] Huang, H. C., & Lin, S. C. (2009). Non-linear finance-growth nexus. *Economics of Transition*, 17(3), 439-466.
- [20] Jude, E. C. (2010). Financial development and growth: A panel smooth regression approach. *Journal of Economic Development*, 35(1), 15.
- [21] King, R. G., & Levine, R. (1993). Finance and growth: Schumpeter might be right. *The Quarterly Journal of Economics*, 108(3), 717-737.
- [22] Law, S. H., & Singh, N. (2014). Does too much finance harm economic growth? *Journal of Banking & Finance*, 41, 36-44.
- [23] Lee, C., & Wong, S. Y. (2005). Inflationary threshold effects in the relationship between financial development and economic growth: evidence from Taiwan and Japan. *Journal of Economic Development*, 30(1), 49.
- [24] Lee, J. (1996). Financial development by learning. *Journal of Development Economics*, 50(1), 147-164.
- [25] Levine, R., Loayza, N., & Beck, T. (2000). Financial intermediation and growth: Causality and causes. *Journal of Monetary Economics*, 46(1), 31-77.
- [26] Levine, R., & Zervos, S. (1998). Stock markets, banks, and economic growth. *American Economic Review*, 537-558.
- [27] McKinnon, R. I. (1973). *Money and capital in economic development* (ed.). Washington,: Brookings Institution.
- [28] Rajan, R. G. (2005). Has financial development made the world riskier? : National Bureau of economic Research.
- [29] Rioja, F., & Valev, N. (2004). Does one size fit all?: a reexamination of the finance and growth relationship. *Journal of Development Economics*, 74(2), 429-447.
- [30] Rousseau, P. L., & Wachtel, P. (2002). Inflation thresholds and the finance-growth nexus. *Journal of International Money and Finance*, 21(6), 777-793.
- [31] Rousseau, P. L., & Wachtel, P. (2011). What is happening to the impact of financial deepening on economic growth? *Economic Inquiry*, 49(1), 276-288.
- [32] Rousseau, P. L., & Yilmazkuday, H. (2009). Inflation, financial development, and growth: A trilateral analysis. *Economic Systems*, 33(4), 310-324.
- [33] Schumpeter, J. A. (1911). 1934. *The theory of economic development*.
- [34] Sehrawat, M., & Giri, A. (2015). Financial development and economic growth: empirical evidence from India. *Studies in Economics and Finance*, 32(3), 340-356.
- [35] Shan, J. Z., Morris, A. G., & Sun, F. (2001). Financial Development and Economic Growth: An Egg-and-Chicken Problem? *Review of international economics*, 9(3), 443-454.
- [36] Shaw, E. S. (1973). *Financial deepening in economic development* (ed. Vol. 270): Oxford University Press New York.
- [37] Shen, C.-H., & Lee, C.-C. (2006). Same financial development yet different economic growth: why? *Journal of Money, Credit and Banking*, 1907-1944.
- [38] Stiglitz, J. E. (1993). The role of the state in financial markets. *The World Bank Economic Review*, 7(suppl 1), 19-52.
- [39]

International Conference For Young Researchers In Economics And Business, ICYREB 2017, October 30<sup>th</sup> 2017  
Da Nang, Vietnam

# The Challenges of The Development of Social Enterprises in Vietnam

Phan Hong Mai<sup>\*a</sup>, Nguyen Ngoc Dung<sup>b</sup>

<sup>a</sup>Phan Hong Mai, PhD, School of Banking and Finance, National Economics University, Hanoi, Vietnam.

<sup>b</sup> Nguyen Ngoc Dung, Faculty of Law, National Economics University, Hanoi, Vietnam.

## ABSTRACT

The paper illustrates the development of social enterprises in Vietnam before 1986 to the end of 2016. Accordingly, the authors point out five main challenges which limited the development of this new model of enterprise, including: (1) shortage of knowledge of social enterprises regarding both policy and practice; (2) less start-up capital and difficulties in accessing capital; (3) limited management ability of the manager; (4) hard to train and develop human resource; and (5) lack of “ecosystem” that can boost the development of social enterprises. In addition, with three typical case studies, the authors also show the difficulties of the market and business methods of these enterprises.

**Keywords:** social enterprises; social services; community

## 1. Introduction

According to the Vietnamese Enterprise Law (No 68/2014 / QH13, dated 11/26/2014), social enterprises have to meet the requirements: (i) the organisation was registered according to the Enterprise Law, (ii) Operational objectives are to solve the social and environmental issues for the benefit of community, and (iii) spend at least 51% annual profit of the organisation to reinvest in order to achieve the registered social and environmental objectives. Therefore, unlike the common businesses and voluntary organisations (most popular is the NGO model), social enterprise have the following characteristics: (i) Have to have business operation and compete fairly with the common businesses; (ii) Social service is the most priority object, business is purely a method to achieve it; (iii) Reinvest the profit to expand operation or distribute to community. Three above characteristics make social enterprises become a more suitable and better model than voluntary organisations and common organisations doing corporate social responsibility (Martin and Osberg, 2007). This has a special meaning as Vietnam became a country with average income (since 2010). The sponsors in Vietnam tend to apply market principles to serve the sustainable development instead of mere aid. On the other hand, social issues such as poverty, disease, cultural distance - intellectual, social service for people with disability, etc. have an increasing trend along with the development of market economy. Thus, expanding social enterprise model to replace NGOs in Vietnam is an inevitable trend, this should be aware accurately and encouraged to develop. However, there are a few academic studies of social enterprises in Vietnam. Based on the idea of Pham and Lam (2012), Le and Pham (2012), Pham et al. (2013), Truong (2015), this paper illustrates the development of social enterprises in Vietnam before 1986 to the end of 2015. Accordingly, the authors point out main challenges limited the development of this new model of enterprise. These findings are scientific basic for making management policies, as well as paving the way for the further studies.

## 2. The development of social enterprises in Vietnam

In 1986, Vietnam was implementing a completely renovation process and in 2010, Vietnam became a country with average income. The development process of social enterprises is divided into three periods, as following:

**Before 1986:** Before 1986, Vietnam applied mechanisms comprehensive centralised management. All social services were distributed to each citizen by the government. All independent social organisations, non-governmental organisations and NGOs were not allowed to operate. In the collective ownership model, there were a few co-operatives

\* Corresponding author, Tel: 0912.807.783, Email: hongmaiktqd@yahoo.com

established to create jobs and support the life of people who belonged to the vulnerable groups in the society (mainly disabled people at that time). They focused on the handicraft areas such as rattan, woven embroidery, and garment. Nhân Đạo co-operative is one typical example (was established in 1973) which had created a range of jobs for disabled people through the productive activities of toothpick, broom and service activities such as massage, reflexology, and so on. However, influenced by negative impacts from crisis in the co-operative sector, which similar to Nhân Đạo, was also not replicated.

**The period from 1986 until the beginning of 2010:** The basic and national innovative process started from 1986 brought two important factors which were the acceptance of the private economic sector and “open” to receive the investment and aid from the foreign countries. According to Nguyen et al. (2011), during this period, there were more than 1,000 NGOs, 320 national associations and 2,150 associations operating based on voluntary, independent principles at central and local level. Additionally, there were thousands of community organisations such as cultural houses, clubs, women, veterans, and disabled people associations. In this situation, some real social enterprises were established and are still developing strongly until nowadays, for example Mai Vietnamese Handicrafts Ltd and KOTO. Being born later (in 2008), but having an important role to promote the activity of social enterprise in Vietnam is Centre for Social Initiatives Promotion (CSIP). CSIP directly supports for the start-up social enterprises, and also attract the involvement of government agencies, businesses and communities.

**The period from 2010 until the end of 2015:** Vietnam became a country with average income is a remarkable achievement, but it also altered the policy to support humanitarian and social development of the countries and international organisations. Some bilateral development agencies such as SIDA, Ford Foundation stopped aid, many countries like Denmark, the United Kingdom decreased ODA for Vietnam. In this situation, CSIP, British Council and Spark Centre for Social Entrepreneurship Development (Spark - founded in 2011) has actively propagated, introduced and supported the establishment of social enterprise as a suitable replacement in accordance with national conditions as well as the worldwide trend. According to the survey of CSIP, British council and Spark (2011), the number of new founded social enterprises in 2010 is 28, bringing the total number of recognised social enterprises to reach 167 enterprises. This survey also illustrated that Vietnam’s social enterprises mainly located in Hanoi and Ho Chi Minh cities – the places where the headquarters of the supporting and local and international development organisations were located. These supporting organisations are mostly operating in the form of centres (32.9%) and companies (29.9%), and in three main areas: education, vocational guidance, handicrafts production and healthcare. In 2010, due to the operation of these 167 social enterprises above, the number of beneficiaries is 377,678; the economic value is about 254 billion VND. Regarding social value, 68.3% of the companies in the above group have contributed to reduce poverty, stabilise life and increase income for those beneficiaries through educational, vocational activities, and so on. The year of 2014 marked a breakthrough turning point for social enterprise community in Vietnam, as for the first time, this model was legalised in the Enterprise Law. By the end of 2015, according to the CSIP, there are about 209 Vietnamese social enterprises operating across the country.

### 3. The challenges of the development of social enterprises in Vietnam

#### 3.1. The common challenges of the development of social enterprises in Vietnam

**Firstly, lack of knowledge of social enterprise regarding both policy and practice.** Although the establishment of social enterprises is stated in Enterprise Law (effective from 1<sup>st</sup> July, 2015) and guided by decree 96/2015 /ND - CP (effective from 8<sup>th</sup> December, 2015), there is not any case of social enterprise that registers to establish or switches operation under this new law on the National Business Registration Portal. The main reason is that there are not any detailed circulars guiding the implementation of the decree, particularly in relation to a number of specific issues such as announcing commitment to implement social and environmental objectives, reporting and assessing social impacts or supervising the operation of social enterprise. In term of reality perception, social enterprise is still a new model, even gets doubted.

**Secondly, limited start-up capital and difficulties in accessing capital.** According to the research of CSIP, British Council and Spark (2011), the start-up capital of social enterprise in Vietnam is still small, averages 1.2 billion VND per company. Beside the capital of the owners, social enterprises are able to call on the funding of international organisations, but they meet many difficulties than the NGO does. On the other hand, social enterprise cannot easily raise capital by way of ordinary business. In the capital structure of social enterprise in Vietnam, own capital accounts for 20.3%. The main source of annual additional capital is the cumulative profit from the business (45.5%), funding is very small (5.3%). The results of interview also noted comments from all social enterprises about their biggest challenges in the development process, which is the lack of funding, expense for investment and development or the accessibility to major loans (37% of interviewees agreed – CSIP, British Council and Spark, 2011). Until now, CSIP and Spark are still the only two centre in Vietnam doing the investment funding program for social enterprise in the amount of approximately USD 200,000/year. This small capital only brings the nature of creating the "seed capital" to activate the ideas and improve competences. It cannot meet the needs of business development. Social impact investment is the most suitable form but still too new in Vietnam.

**Thirdly, limited management ability of the manager.** In reality, most of social enterprises in Vietnam are managed by the founders of the businesses. They are the staffs of local social services or in charge of projects. They have experience but are lack of business knowledge and management. The new social enterprise group, established after 2010, is created by the younger generation. They are well trained but lack of ability to connect and go along with the community, so it is less likely for the model to be expanded. Recruiting high quality managers in social enterprises is not feasible due to the lack of funding and inability to get suitable staffs. Until now, CSIP is the first and only organisation which provides some training courses only for social enterprise, including: the overall development of social enterprise, business planning skill, leadership skill in social enterprise, personal advisors and consultants to develop social enterprise, etc. Nevertheless, the possibility of counselling for each specific social enterprise is limited.

**Fourthly, difficulties of human resource training and development.** Employees of social enterprises are people who need support, belong to the bottom group of society, including disabled people, disadvantaged children, rural women, ethnic minorities, people with complex social situations or having HIV/AIDS, etc. Most of them have low level of knowledge and job skills. Their difficult life circumstances or poor health lower their labour productivity. Moreover, their wages are unstable. Thus, social enterprises have to spend lots of money and time to train their employees and develop the new ones. Another difficulty is the training process for the employees. At the moment, the government also does not have any preferential policies for people involved in this field. In addition, the discriminate status in the community also prevents the employees who are disabled people, people with special circumstances after the training and having vocational qualification in social enterprise from the opportunities to get a job.

**Finally, lack of "ecosystem" that can boost the development of social enterprises.** According to the research of Truong (2015), "ecosystem" for social enterprises in Vietnam has formed but not fully and need to be completed in legal frameworks, policies for financial assistance, trade promotion, researches and above all is developing the spirit for social business. For social enterprises, the research of CSIP, British Council and Spark (2011) illustrated that there are 86.8% opinions proposing to strengthen attention, facilitate, support from the government, as well as local and foreign organisations and individuals. 22.8% of organisations want to be created opportunities to connect and cooperate with other entities. Two above issues are all in the "ecosystem" of social enterprises, as defined by the European Commission (European Commission, 2014).

### 3.2. The specific challenges of the development of some typical social enterprises in Vietnam

#### 3.2.1. *Tò he social enterprise and the issue of "emotional quality"*

The director Pham was selected as one of 121 Young Global Leaders 2016 by the world Economic Forum (WEF). Tò he has become a typical of Vietnam social enterprise by creativity, and contribution toward changing the way to address global issues. The principal is to create free artistic playground for disadvantaged children. The enterprise uses their paintings in decorative motifs on fashion products and trade. Their ideas and social impact are widely appreciated but like major social enterprises in Vietnam, Tò he has to deal with difficulties in capital and operating.

Start-up capital and additional funds mainly come from family property of Pham and Nguyen (co-founders). In 2011, Tò he received funding from the German Development Cooperation (GIZ). Since 2013, the enterprise was regularly supported by investment fund LGT Compassion list. CSIP also supported the organization to raise capital through crowd funding but has not succeeded. The campaign ended after 2 months' implementation with the proceeds of \$ 1,707 (11% original target). Economic losses occurred in three years of 2011, 2012, and 2013, and improved in 2014, 2015, which only helped businesses not be dissolved. Benefit from the business to supplement the social activities are negligible. Tò he had to shrink its business, even once stop working due to limited funding.

Regarding operating capacity, both Pham (BA in Chinese) and Nguyen (artists) are not equipped with all the business knowledge, self-admittedly worked so passionate, "no regret about their loss" and to enhance "emotional quality". The gaudy and respected artistic value in each design, fabric, ink, and printer selection made four times higher cost of their products in comparison to China. Despite high quality, this limited their competitiveness. Distribution and export have not been focused, Tò he is unable to reach its target customers. Apart from these two difficulties, Tò he products, despite the value of art and humanity, are not widely accepted and enjoyed by general shoppers. Thus, existing customers of Tò he mostly are businesses and foreign organizations. Most products are sent to participate in fairs and international exhibitions with low consumption capacity.

#### 3.2.2. Social enterprises Tre Xứ Thanh and issues of "economic purpose".

Tre Xứ Thanh was founded in 2010 to promote the sustainable development of animal farming in 5 poorest mountainous districts of western Thanh Hoa. It provides high quality seed with technical advice and marketing for the local farmers, and cooperates to promote agricultural micro-entrepreneurs in rural areas. By farm scale expansion, business had a turnover of VND 3 billion in 2012 (compared with VND 4 billion of charter capital) and was awarded as the social enterprise of the year. It is also launching research and production in carbonization stream. Successfully tested, Tre Xứ Thanh has made further steps forward to utilize waste streams from carbonization streams to produce

activated carbon.

It was difficult to expand into northern mountainous provinces. Since 2014, carbonization and activated carbon products have been stably consumed in France and Japan which brought great economic value. Accordingly, Tre Xú Thanh split farming out business by establishing Phuong Nam green bamboo LTD with social benefits merely being to reduce environmental pollution (utilizing 5-10% waste) and employed about 60 ethnic minority workers. Information about the operation of the company is not published, even on the website and annual report 2015 of CSIP. Thus, after 5 years of operation, the economic benefit of Tre Xú Thanh has increased but the mission has changed from "help mountainous people in general and marginalized communities in particular have fulfilled and happy life in their homeland" to "optimize the value of the supply chain in the bamboo industry". In other words, the economic purpose has overwhelmed social purposes that made a social enterprise gradually diverted into a common company with social responsibility.

### 3.2.3. *Đi chung social enterprise and issues of "business idea"*

Đi chung was established in 2013 to develop Dichung.vn, the first social network in Vietnam to help people share the vacant seat on the vehicle. This not only saves travel costs for individuals, but limits fuel consumption and gas emissions, and traffic congestion. The competitive advantage of Đi chung is situated in the idea of doing business by solving societal problems, which is widely accepted by the market. Until March 2016, the website has recorded 17,308 successful trips, saving customers VND 3.8 billion and reducing 352,322 kg of CO<sub>2</sub>. The operation is based on smart technology solutions created by the founders that did not require large initial investment, and costs can be reduced by partnership. The social issues are necessary but not too complex to solve as welfare, health, and education. Thus, Đi chung succeeded from the start and was awarded for environmentally friendly businesses of UN 2013. However, the challenge is the lack of creativity breakthrough in business idea that is adapted from world experience, adjusted for Vietnam market. Capital is not large so easily copied business model. This makes Đi chung subject to face high competition from major transportation organizations in Vietnam and information technology field. To sustain businesses, Đi chung would certainly need greater resources to be a pioneer or to provide unique services.

## 4. Solutions to develop social enterprises in Vietnam

Thus, although social enterprises are officially legalised in Vietnam, there are still not conditions which are completed at the legal frameworks and supporting policies for development, as well as it has not yet received necessary attention and coordination from the community. Social enterprises themselves also have difficulties in terms of capital and human resources. To develop successful social enterprise model in Vietnam, some below solutions should be applied:

### 4.1. For the government

Firstly, a circular guiding Decree 96/2015/ND-CP needs to be issued quickly to create a uniform basic for the establishment and operation of social enterprise. In particular, the government needs to specially clarify the controlling system of the government management agencies at all levels for the operation and financial situation of social enterprise, as well as the basic requirements for internal management in social enterprise to ensure that the organisations comply with the commitments of social, environmental, especially profitable distributing content and use of funds (if have any).

Issuing a national program about encouraging the development of social enterprises which emphasise the participations and support of the government management agencies at all levels, the local political – social organisations to the development process, operation and connecting the community of social enterprises. At the same time, issuing financial incentives including: exemption, reduction of corporate income tax for social enterprise and funding, supporting the establishment and development activities of social enterprise; Allowing preferential loans from bank for social policies or from commercial banks at low interest rates; Guaranteed by the local governments to borrow in the case of absence of collateral.

Enhancing the collecting, creating a general national database of social enterprises to sever the research activities and policy advices; Orienting social investment; Propagating and disseminating knowledge about social enterprises.

Improving and developing the basic training system for disabled people, children in difficult or specially circumstances. Applying incentives, financial support to organisations and individuals engaging to the education, vocational training and community reintegration for vulnerable groups and special people.

### 4.2. For the centres for social initiatives promotion

Further promoting the propaganda and introducing activities for social enterprises across the country, focusing on the cities which do not have identified social enterprise (according to the research of CSIP, British Council and Spark,



2011). Diversifying the way of propaganda, regularly updating information on successful case studies.

Enhancing training activities in business and management skills for social entrepreneurs. Combining with the formal education system to integrate social responsibility education into the under-graduated and post-graduated programs; Adding practical activities, community connections for high school students.

Helping to create the connection between social enterprises, social entrepreneurs which led to form a network or an association of social enterprises and social entrepreneurs to share experiences, knowledge, and even business resources, as well as to increase influence and spread to the community.

Collecting, connecting creative ideas with community of social entrepreneurs as a premise to "seed" for social enterprise or support the operation of social enterprises to become more efficient.

Finalising the evaluation criteria for operating results of social enterprises on both economic and social aspects, for each specific sector. This will be the basis for the government agencies to standardise how to assess the effective performance of social enterprise.

#### 4.3. For social enterprises

Putting efforts to find innovative business solutions, focusing on niche markets to avoid highly competitive pressures. Especially, it is necessary to apply effective cost management to reduce overall operating costs.

Creating transparency internal management system, fully complying with the social and environmental commitments to build trust with the community and to attract funding from local and international organisations.

#### References

- [1] Centre for Social Initiatives Promotion (CSIP), British Council and Spark Centre for Social Entrepreneurship Development (Spark) (2011), '*Report the survey of social enterprise in Vietnam in 2011*', available from <<http://csip.vn/vi/content/bao-cao-ket-qua-khao-sat-doanh-nghiep-xa-hoi-viet-nam-2011>>. [Accessed 25 February 2016].
- [2] European Commission, (2014), '*A map of social enterprise and their eco-systems in Europe*', European Union.
- [3] Le T. H. and Pham T. G. (2012), '*Development of Social enterprises: Role of the Government and Citizens*', Economic and Development Journal, No. 186(II), pp. 37-43.
- [4] Martin R. L. and Osberg S., (2007), '*Social Entrepreneurship – the Case for Definition*', Stanford Social Innovation Review, accessed 25/2/2016 available from <[http://ssir.org/articles/entry/social\\_entrepreneurship\\_the\\_case\\_for\\_definition](http://ssir.org/articles/entry/social_entrepreneurship_the_case_for_definition)>.
- [5] Nguyen D. C., Luu M. D., Pham K. O. and Tran T. H. G., (2012), '*Social enterprise in Vietnam, definition, context and policy*', available from <<https://www.britishcouncil.vn/sites/default/files/dnxh-tai-viet-nam-khai-niem-boi-can-h-chinh-sach.pdf>>. [Accessed 25 February 2016].
- [6] The 13th National Assembly, (2014), Law Enterprise No. 68/2014/QH13, issued 26th November 2014.
- [7] The Government, (2015), Decree 96/2015/ND-CP regulates a number of articles of the Enterprise Law in detail, issued 19th October 2015.
- [8] Pham H. T. and Lam N. T. (2012), '*Social enterprise: a model of sustainable development for businesses Vietnam*', Economic and Development Journal, No. 181(II), pp. 112 - 118.
- [9] Pham V. T., Nguyen T. H. H. and Nguyen T. N. A. (2013), '*Social Enterprise - The experience of the Asian countries on the development model and recommendations for Vietnam*', Economic and Development Journal, No. 198(II), pp. 48-54.
- [10] Truong T. N. T., (2015), '*Ecosystem for social enterprise: international research and recommendation policy for Vietnam*', Economic and Development Journal, No. 217(II), pp. 97 - 104.

# Research on Fraud Risk Factors Affecting Fraudulent Financial Reporting of Non-Financial Companies Listed on Vietnam's Stock Market

Ta Thu Trang, Doan Thanh Nga\*

School of Accounting and Auditing, National Economics University, Hanoi, Vietnam

## ABSTRACT

This paper focus on common fraud risk factors affecting fraud in preparing financial statements of non-financial companies listed on Vietnam's stock market. By reviewing literatures and theoretical frameworks for fraud risk factors mentioned in The International Auditing Standard (ISA) No. 240 (IAASB, 2009) and Vietnamese Auditing Standard (VSA) No. 240 (Vietnamese Ministry of Finance, 2012), we use qualitative research methods combined with quantitative research methods to synthesize and analyze common fraud risk factors affecting fraudulent financial reporting of non-financial companies listed on Vietnam's stock market. Through literature review, analysis and interview results, 20 fraud risk factors affecting fraud in preparing financial statements were identified. However, these results show that there are some important fraud risk factors that used by audit firms and auditors to assessing fraud risk in financial statements auditing, in order to mitigate audit risks. Therefore, auditors should recommend clients to take some actions to control these fraud risk factors and mitigate fraud risk in preparing financial statements.

**Keywords:** fraud risk factor; non-financial listed company; fraudulent financial reporting.

## 1. Introduction

It is always a challenge for auditors and audit firms to detect fraud that has a material impact on the financial statements. In order to detect fraud in financial statements auditing, ISA No.240 and VSA No.240 require auditors and audit firms to assess fraud risk affecting the preparation of financial statements, in which identifying fraud risk factors is an important part of the work that auditors and audit firms must determine. Fraudulent behavior is a sophisticated misconduct that auditors and audit firms find it difficult to detect. In order to detect fraud in preparing financial statements, auditors and audit firms must investigate the cause of fraud or otherwise they must detect fraud risk signs (red flags) to identify such fraud.

## 2. Literature review

In order to commit fraud, Fraud Triangle theory (Cressey, 1953) and Red-flags (Romney et al., 1980) are the mainstream theories to explain causes of frauds. This paper reviews international researches on the causes of fraudulent behavior in preparing financial statements including three groups of internal factors (pressures/incentives, opportunities and attitudes/rationalization) and red-flags in these three groups.

Based on the study of Red-flags, Albrecht et al. (1986) conducted the first empirical study on the usefulness of red-flags to predict fraud. The authors use 87 signs to design questionnaires to interview independent auditors. The results of the study show that the pressures/incentives factors and attitudes factors are two of the most important red-flags in fraud prediction

In 1988, American Institute of Certified Public Accountants (AICPA, 1988) issued Statements on Auditing Standards (SAS) No. 53 replacing SAS No. 16 (AICPA, 1977), entitled "The Auditor's Responsibility to Detect and Report Errors and Irregularities". In SAS No. 53, the AICPA issued red-flags (or fraud risk factors) divided into three

\* Corresponding author. Tel.: +84982800705  
E-mail address: tthtrang7050@yahoo.com

groups, including *Management's characteristics* and influence over the control environment; Industry conditions and operating characteristics; Characteristics of the audits. In comparisons with the Fraud Triangle theory, the attitudes/rationalization factors group is related to the *Management's characteristics* and influence over the control environment, the pressures/incentives factors group related to Industry conditions and operating characteristics, the opportunities factors related to characteristics of the audit. After issuing SAS No. 53, a number of studies focused on identifying important fraud risk factors that influence fraud in preparing financial statement, but there is still a limitation and inadequacies to adequately represent the fraud risk factors in the current economy. The AICPA continued to amend SAS No. 53 and issued SAS No. 82 entitled Consideration of Fraud in A Financial Statement Audit in 1997 (AICPA, 1997). After a series of United States of America's financial scandals in 2001 and 2002, AICPA continued replacing SAS No. 82 with SAS No. 99 entitled "Consideration of Fraud in a Financial Statement Audit" to complete the fraud risk factors in line with the changing economy (AICPA, 2002). The AICPA subgroups fraud risk factors into three categories (pressures/incentives, opportunities and attitudes/rationalization) following Fraud Triangle theory. In 2004, the International Commission on Standards of Auditing and Services undertook the revision of ISA No. 240 entitled "The auditor's responsibilities relating to fraud in an audit of financial statements".

Many studies on fraud risk factors affecting fraudulent financial reporting have been conducted in various parts of the world and are carried out at different stages which associated with the establishment and development of the international auditing standard system (SAS No. 16, SAS No. 53, SAS No. 82, SAS No. 99, ISA No. 240). Albrecht et al. (1986), Heiman-Hoffman et al. (1996), Moyes et al. (2005), Smith et al. (2005), Moyes (2007), Gullkist and Jokippi (2013) and Abdullatif (2013) found that the group of attitudes/rationalization factors has the most important influence on fraud in preparing financial statement comprise , attitudes/rationalization factors consist of management and board of directors with a history of violation of the law on securities or related laws; managers of the dishonest and morally weak; deliberately limiting the scope of the audit; the board of management monopolized and internal controls of company overridden; auditors are limited to access to staff and information.

On the other hand, Bell and Carcello (2000), Graham and Bedard (2003), Gramling and Myers (2003), Moyes et al. (2005), Skousen and Wright (2006), Moyes (2007); Gullkist and Jokippi (2013), Abdullatif (2013) indicate that major opportunity factors influencing fraud in preparing financial statements include the ineffectiveness of internal controls, the existence of significant or abnormal transactions with related parties, the occurrence of transactions near the end of accounting period, lack of monitoring activities for managers.

The last group of factors is pressures/incentives influencing fraud in preparing financial statements given by studies by Albrecht et al. (1986), Bell and Carcello (2000), Graham and Bedard (2003), Smith et al. (2005), Skousen and Wright (2006), Moyes (2007); Gullkvist and Jokippi (2013), Abdullatif (2013) Overall, they conclude that the major pressures/incentives factors affecting fraudulent financial reporting are financial difficulties, solvency and capital mobilization difficulties, bankruptcy pressures, financial goals pressures (sales, profit targets,...), the majority income of the managers or the board of directors depends on stock prices or business results.

In the context of Vietnam, Ly Tran Kim Ngan (2011), Le Nguyen The Cuong (2013) identified the most important fraud risk factors are the company under pressure on financial goals, followed with the pressure from investors and equity. For the opportunity factors, internal control's weaknesses influence on fraud in preparing financial statements (Le Nguyen The Cuong, 2013). Tran Thi Giang Tan et al. (2014) identified some factors in the groups of pressures/incentives, opportunities and attitudes/rationalization causing fraud in preparing financial statements.

**In short**, a majority of research works were conducted in developed countries but there are few studies conducted in Asia and the developing countries context, especially in Vietnam. From the above overview, the authors identify that researching in fraud risk factors affecting fraudulent financial reporting of non-financial companies listed on the stock market of Vietnam (a developing country) is an essential issue which need to be addressed.

### 3. Theoretical framework on fraud risk factors affecting fraudulent financial reporting

According to Cressey's Fraud Triangle theory, fraud is based on three groups of factors: pressures/incentives, opportunities and attitudes/rationalization. In criminal investigations, detecting crime should be based on signs of criminal behavior. In order to find fraud in preparing financial statements, auditors should base on signs of the cause of fraud (pressures/incentives, opportunities and attitudes/rationalization factors group) to predict fraud. These predictive signs are called red-flags (Romney et al., 1980). The red flags are latent signs that exist in the business environment of a company that is capable of predicting risk of intentional misstatement in financial statements (Waterhouse, 1985). The red-flag is a term that correlates with the identification of fraudulent signs and indicates the potential for fraudulent behaviour (Vona, 2011).

In ISA No. 240 and VSA No. 240, red flags which are referred to as the "factors that drive the risk of fraud" (referred to as fraud risk factors) are events or conditions that emphasize an incentive or pressure to commit fraud or create opportunities for committing fraud (IAASB, 2009; Vietnamese Ministry of Finance, 2012).

International studies, ISA No. 240 and VSA No. 240 have included fraud risk factors used to predict fraud in preparing financial statements, including pressures/incentives, opportunities and attitudes/rationalization.

Firstly, pressures/incentives factors affecting fraud in preparing financial statements: Studies by Romney et al.

(1980), Albrecht et al. (1986), Bell and Carcello (2000), Apostolou et al. (2001), Graham and Bedard (2003), Gramling and Myers (2003), Moyes et al. (2005), Mock and Turner (2005), Smith et al. (2005), Skousen and Wright (2006), Moyes (2007), Ly Tran Kim Ngan (2011), Gullkvist and Jokippi (2013), Abdullatif (2013), Le Nguyen The Cuong (2013), Tran Thi Giang Tan et al. (2014) show pressures/incentives factors have significant influence on fraud in preparing financial statements as follows:

- The economic situation, business or operating conditions of the company affect the financial stability or profitability of the company;
- Management is under high pressure to meet the requirements of the third party;
- The business results of the company affect the personal financial situation of the board of management or the board of directors such as salaries and bonuses;
- Management is under pressure to achieve financial goals such as sales or profit rate set by the board of directors.

Secondly, the group of opportunity factors influencing fraudulent financial reporting: Studies by Romney et al. (1980), Bell and Carcello (2000), Apostolou et al. (2001), Gramling and Myers (2003), Graham and Bedard (2003), Moyes et al. (2005), Mock and Turner (2005), Smith et al. (2005), Skousen and Wright (2006), Gullkvist and Jokippi (2013), Abdullatif (2013), Le Nguyen The Cuong (2013), Tran Thi Giang Tan et al. (2014) detects fraud risk factors related to opportunities affecting fraudulent financial reporting:

- Business or operating characteristics of the company may create opportunities for fraud in financial statements;
- The supervision of the board of directors against board of management is ineffective;
- The company's structure is complex or unstable;
- Internal controls are not effective.

Thirdly, the group of attitudes/rationalization factors affecting fraudulent financial reporting: The studies by Romney et al. (1980), Albrecht et al. (1986), Heiman-Hoffman et al. (1996), Bell and Carcello (2000), Apostolou et al. (2001), Gramling and Myers (2003), Graham and Bedard (2003), Moyes et al. (2005), Mock and Turner (2005), Smith et al. (2005), Moyes (2007), Gullkvist and Jokippi (2013), Abdullatif (2013), Tran Thi Giang Tan et al. (2014) show the attitudes/rationalization factors influencing fraud in preparing financial statements:

- The level of management to communicate, implement, support or demand the implementation of corporate culture or professional ethics standards is inappropriate or ineffective;
- Members of the board of management do not have financial expertise but interfere or impose excessive on the selection of accounting policies or determine accounting estimates;
- A history of legal violation of securities laws or other regulations, board of directors or board of management were accused of fraud or law violation;
- Management is overly concerned about maintaining or increasing stock prices;
- Board of management does not timely correct material deficiencies of internal controls;
- Board of management continually justifies for inappropriate accounting methods based on materiality;
- Tension in the relationship between the board of management and the existing audit firm such as the board restricts auditors to accessing to employees or informing the board of directors; the board of management has behavior to constrain auditors, limit the scope of audit;
- Board of management colludes with analysis expertise, creditors and third parties to achieve too high or unrealistic forecasts.
- Members of the board of management have weak ethics.

#### 4. Research Methods

Quantitative research methods combined with qualitative research methods were used to identify fraud risk factors affecting fraudulent financial reporting. 12 common fraud situations in preparing financial statements of listed companies in the world and in Vietnam were synthesized and analyzed. This result was combined with the results of interviewing 06 Vietnamese auditors who have ten or more years of professional experience in auditing companies listed on Vietnam's stock market to identify fraud risk factors influencing fraudulent financial reporting. Through literature review, analysis and interview results, 20 fraud risk factors affecting fraud in preparing financial statements were identified, that was basis for conducting a large-scale survey of eligible auditors who have five or more years of experience working at audit firms approved to audit companies listed on Vietnam's stock market. Questionnaire was used for data collection. Responses to each question were scored on a five-point Likert scale ranging from a low score of 1 (= completely uncommon) to a high score of 5 (= completely common). The total number of questionnaires sent was 400 and the valid answers received were 103. SPSS software was used to conduct statistical analysis to identify common fraud risk factors (pressures/incentives, opportunities and attitudes/rationalization) influencing fraud in preparing financial statements.

## 5. Descriptive analysis

Based on the understanding of business and internal controls, auditors evaluate fraud risk factors in three groups of factors that influence fraud in preparing financial statements.

For the pressures/incentives factors, the pressure on board of management or executives to achieve the financial targets set by the board of directors (3.57 points) and the pressure from the completion of listing on Vietnam's stock market requirements or debt settlement (3.46 points); the pressure from loss in business result threatening to bankruptcy, foreclosure (3.38 points); the pressure of profit margin or the expectation of investment analysts and investors, the board of management optimistic about the information in the annual report (3.27 points) are four common factors affecting fraudulent financial reporting (average score over 3.0 points). Specifically, the pressure related to achieve financial goals such as profit targets, the board of directors' revenue imposed on management to achieve the target set in the year is the biggest pressure for management to adjust figures on financial statements. Next, for companies preparing to list on the stock market or plan to issue more shares, the pressure to complete procedures for listing or issuing additional shares is a common reason for the board of management editing data on the financial statements. The third common pressure is the loss of financial result of listed companies. According to the regulations of State Securities Commission of Vietnam, the listed companies with loss result will be put into warning status and cancel listing if have three consecutive years of unprofitable business. In addition, the pressures associated with the expectations of the investment community, board of management's too optimistic about the annual report also affecting on fraud in preparing financial statements of the company. The board of directors' and management's earnings depending on business performance, stock price, financial status and cash flow may be a factor impacting fraud in preparing financial statements (2.94 points). However, the pressure of rapid growth to occupy the industry's leading position is the least common factor affecting fraudulent financial reporting.

**Table 1. Statistical results on the prevalence of the pressures/incentives factors affecting fraudulent financial reporting**

Pressures/incentives factors	Number of observations	Minimum score	Maximum score	Average value	Standard deviation
Pressure on board of management or executives to achieve the financial targets set by the board of directors	103	1	5	3.57	0.858
Pressure from the completion of listing on Vietnam's stock market requirements or debt settlement	103	1	5	3.46	0.988
Pressure from loss in business result threatening to bankruptcy, foreclosure	103	1	5	3.38	1.096
Pressure of profit margin or the expectation of investment analysts and investors, the board of management optimistic about the information in the annual report.	103	1	5	3.27	0.987
The board of directors' and management's earnings depending on business performance, stock price and financial status and cash flow.	103	1	5	2.94	0.983
Pressure of rapid growth to occupy the industry's leading position	103	1	5	2.87	0.919
Valid N (listwise)	103				

(Source: Results from the authors' study)

For the opportunities factors, the most commonly considered factors in this group is items in financial statement which are based on accounting estimates (3.43). There are many accounting estimates in financial statements, such as provisions (provision for doubtful debts, provision for devaluation of securities investments, provisions for depreciation of inventories, provision for product warranty), depreciation of fixed assets which are a good opportunity for management of company to commit fraud in order to adjust financial statements. Subsequently, factors related to significant transactions with related parties outside the normal business activities or related entities audited by other

audit firms or not yet audited with an average score of 3.37 points. Transactions with related parties are always complex. Surveys on common fraud schemes in the world mainly found that fraud through related party transactions by transferring loss and debt to related parties or subsidiaries with special purposes. Finally, the sign of unusual or complex transactions occurred near the end of the accounting period (3.31 points). This is a good opportunity for listed companies to adjust the profitability if the revenue target is not reached at the end of the accounting period. However, the signs of frequent changing the board of management or the board of directors; the supervision of the board of directors against the process of preparing financial statements and internal controls is ineffective; using of unrelated intermediaries, inefficient accounting systems and information systems are opportunities to consider impacting on fraud in preparing financial statements (average scores above 2.9 points). Lack of monitoring of internal controls in preparing financial statements is a less common factor that influences fraud in preparing financial statement because auditor may believe that fraud in preparing financial statements is often controlled by board of management or board of directors.

**Table 2. Descriptive Statistics results about the prevalence of the opportunity factors affecting fraudulent financial reporting**

<b>Opportunities factors</b>	<b>Number of observations</b>	<b>Minimum score</b>	<b>Maximum score</b>	<b>Average value</b>	<b>Standard deviation</b>
Assets, liabilities, revenues, costs are determined based on important accounting estimates	103	1	5	3.43	0.881
Significant transactions with related parties outside the normal business activities or related entities audited by other audit firms or not yet audited	103	1	5	3.37	0.889
Unusual or complex transactions occurred near the end of the accounting period	103	2	5	3.31	0.771
Frequent change of the board of management or the board of directors	103	1	5	2.96	0.896
The supervision of the board of directors against the process of preparing financial statements and internal controls is ineffective	103	1	5	2.95	0.883
Using of unrelated intermediaries	103	1	5	2.92	0.904
Inefficient accounting systems and information systems	103	1	5	2.91	0.830
Lack of monitoring of internal controls in preparing financial statements	103	1	5	2.88	0.932
Valid N (listwise)	103				

(Source: Results from the authors' study)

For the group of attitudes/rationalization factors, members of the board of management do not have financial expertise but interfere or impose excessive on the selection of accounting policies or determine accounting estimates (3.34 points) and management is overly concerned about maintaining or increasing stock prices (3.2 points) are the common factors affecting fraudulent financial reporting. Next, the board of management restricts auditors to accessing to employees or informing the board of directors, poor management of moral norms are factors that should be considered to influence fraudulent financial reporting (average score is approximately 3.0). A history of legal violation of securities laws or other regulations of listed non-financial companies and the board of management has behavior to constrain auditors, limit the scope of audit are less common factors that affect fraud in preparing financial statements (about 2.77 points).

**Table 3. Statistical results on the prevalence of the group of attitudes/rationalization factors affecting fraudulent financial reporting**

Attitudes/rationalization factors	Number of observations	Minimum score	Maximum score	Average value	Standard deviation
Members of the board of management do not have financial expertise but interfere or impose excessive on the selection of accounting policies or determine accounting estimates	103	1	5	3.34	1.017
Management is overly concerned about maintaining or increasing stock prices	103	1	5	3.20	0.921
Board of management restricts auditors to accessing to employees or informing the board of directors	103	1	5	2.94	0.958
Poor management of moral norms	103	1	5	2.93	1.122
A history of legal violation of securities laws or other regulations of listed non-financial companies	103	1	5	2.77	0.917
Board of management has behavior to constrain auditors, limit the scope of audit.	103	1	5	2.76	1.164
Valid N (listwise)	103				

(Source: Results from the authors' study)

## 6. Discussion and recommendations from the research results

Identifying fraud risk factors affecting fraud in preparing financial statements is an important step for audit firms and its auditors in undertaking fraud risk assessments. Fraud risk factors with direct impact on fraud in financial reporting are groups of pressures/incentives, opportunities and attitudes/rationalization. The research results show that the pressures/incentives factors group has the most impact, followed by the opportunities factors group and finally the attitudes/rationalization factors group. Specifically, the pressures/incentives group consists of four factors, the opportunities group consists of three factors and the attitudes/rationalization group consists of two common factors affecting fraud in preparing financial statements. Through the identification of fraud risk factors in preparing financial statements, the authors made some recommendations to audit firms and auditors on advising clients to reduce fraud risk factors affecting fraudulent financial reporting (pressures/incentives, opportunities and attitudes/rationalization factors).

For pressures/incentives factors such as pressure on financial targets, pressure from the completion of listing on Vietnam's stock market requirements or debt settlement, the pressure from loss in business result threatening to bankruptcy or foreclosure, listed non-financial companies should take measures to minimize those pressures by developing the financial and business planning in the short, medium and long term with specific and detailed phases. These plans must be based on the reality of the companies and placed in the general context of the economy and the dynamics of the industry in order to develop a feasible and sustainable financial and business planning system and strategy with the aim of not putting pressure on management to adjust data to achieve financial goals from the board of directors or expectations of third parties. Financial and business plans and strategy must be informed specifically to investors and shareholders for sharing and understanding the progress of business operations of the company, therefore, they will not to put pressures on the board of management.

For opportunities factors, the board of management often abuses the authority to override internal controls, therefore, the board of directors needs to strengthen its supervisory function and control over such frauds. In particular, the company should designs an effective control environment, enhances periodic control activities, establish an independent management structure between the board of management and the board of directors (no concurrent function between the chief executive officer and the chairman of board of directors - avoiding conflict of interest in the company). In addition, listed non-financial companies should build corporate governance capabilities to create a complete, transparent, and effective regulatory environment from the highest levels of management: board of directors, audit committee, board of management; separate executive functions from monitoring and approval functions; build a complete and transparent administrative information system from the top to the lower level to minimize the

opportunities for committing fraud. The board of directors should take measures and sanctions to strictly prohibit frauds in the organization and at all management levels of listed non-financial companies.

To reduce the attitudes/rationalization factors affecting frauds in preparing financial statements, companies need to uphold governance principles for integrity of the board of management and the board of directors, such as codes of ethics - promoting honest and ethical behaviors of management and staffs. In addition, the companies should develop a criteria system of expertise and professional ethics for staff assessment, especially promote the honesty in the work to select, recruit and evaluate management positions, such as chief executive officer, chief financial officer, and chief accountant.

## References

- [1] Abdullatif M. (2013), Fraud risk factors and audit programme modifications: Evidence from Jordan, *Australasian Accounting Business & Finance Journal*, 7(1), 59.
- [2] Albrecht, W. S., Romney, M. B., Cherrington, D. J., Payne, I. R., Roe, A. J., & Romney, M. B. (1986), Red-flagging management fraud: A validation, *Advances in Accounting*, 3, 323-333.
- [3] American Institute of Certified Public Accountants (AICPA) (1977), Statement on Auditing Standards No. 16 (1977) - The Independent Auditor's Responsibility, Inc. New York, NT.
- [4] American Institute of Certified Public Accountants (AICPA) (1988), Statement on Auditing Standards No. 53 (1988) - *The auditor's responsibility to detect and report errors and irregularities*, Inc. New York, NT.
- [5] American Institute of Certified Public Accountants (AICPA) (1997), Statement on Auditing Standards No. 82 (1997) - Considerations of Fraud in a Financial Statement Audit, Inc. New York, NT.
- [6] American Institute of Certified Public Accountants (AICPA) (2002), Statement on Auditing Standards No. 99 - Considerations of Fraud in a Financial Statement Audit, Inc. New York.
- [7] Apostolou, B. A., Hassell, J. M., Webber, S. A., & Summers, G. E. (2001), 'The relative importance of management fraud risk factors', *Behavioral Research in Accounting*, 13(1), 1-24.
- [8] Bell, T. B., & Carcello, J. V. (2000), 'A decision aid for assessing the likelihood of fraudulent financial reporting', *Auditing: A Journal of Practice & Theory*, 19(1), 169-184.
- [9] Cressey, D. R. (1953), *Other people's money: A study of the social psychology of embezzlement*, Glencoe, IL. Free Press.
- [10] Graham, L., & Bedard, J. C. (2003), 'Fraud risk and audit planning', *International Journal of Auditing*, 7(1), 55-70.
- [11] Gramling, A. A., and Myers, P. M. (2003), 'Internal auditors' assessment of fraud warning signs: Implications for external auditors', *The CPA Journal*, 73(6), 20-25.
- [12] Gullkvist, B., and Jokipii, A. (2013), 'Perceived importance of red flags across fraud types', *Critical Perspectives on Accounting*, 24(1), 44-61.
- [13] Heiman-Hoffman, V. B., Morgan, K. P., & Patton, J. M. (1996), 'The warning signs of fraudulent financial reporting', *Journal of Accountancy*, 182(4), 75-81.
- [14] International Auditing and Assurance Standards Board (IAASB) (2009), International Standards on Auditing (ISA) 240 "The auditor's responsibility to consider Fraud in an Audit of Financial Statements", Retrieved June 9, 2017 from <http://www.ifac.org/system/files/downloads/a012-2010-iaasb-handbook-isa-240.pdf>
- [15] Le Nguyen The Cuong (2013), Giải pháp nâng cao trách nhiệm của kiểm toán viên độc lập đối với việc phát hiện gian lận và sai sót trong kiểm toán báo cáo tài chính của công ty niêm yết Việt Nam, Master thesis, University of Economics Ho Chi Minh City, Vietnam.
- [16] Ly Tran Kim Ngan (2011), Hoàn thiện thủ tục kiểm toán nhằm phát hiện gian lận trên báo cáo tài chính của công ty niêm yết tại Việt Nam, Master thesis, University of Economics Ho Chi Minh City, Vietnam.
- [17] Mock, T. J. & Turner, J. L. (2005), 'Auditor identification of fraud risk factors and their impact on audit programs', *International Journal of Auditing*, 9(1), 59-77.
- [18] Moyes, G. D. (2007), 'The Differences In Perceived Level Of Fraud-Detecting Effectiveness Of SAS No. 99 Red Flags Between External And Internal Auditors', *Journal of Business & Economics Research*, 5(6), 9-25.
- [19] Moyes, G. D., Lin, P., & Landry Jr, R. M. (2005), 'Raise the red flag: a recent study examines which SAS No. 99 indicators are more effective in detecting fraudulent financial reporting', *Internal Auditor*, 62(5), 47-52.
- [20] Romney, M. B., Albrecht, W. S., & Cherrington, D. J. (1980), 'Red-flagging the white collar criminal, *Management accounting*', 61(9), 51-57.
- [21] Skousen, C. J. and Wright, C.J. (2006), Contemporaneous risk factors and the prediction of financial statement fraud, Working paper, University of Texas at Arlington.
- [22] Smith, M., Haji Omar, N., Iskandar Zulkarnain Sayd Idris, S., & Baharuddin, I. (2005), 'Auditors' perception of fraud risk indicators: Malaysian evidence', *Managerial Auditing Journal*, 20(1), 73-85.
- [23] Tran Thi Giang Tan, Nguyen Tri Tri, Dinh Ngoc Tu, Hoang Trong Hiep and Nguyen Dinh Hoang Uyen (2014), Đánh giá rủi ro gian lận báo cáo tài chính của các công ty niêm yết tại Việt Nam, *Journal of Economic Development*, 26(1), 74-94.
- [24] Vietnamese Ministry of Finance (2012), Circular 214/2012/TT-BTC on Vietnamese auditing standards, dated



December 6th 2012.

- [25] Vona, L. W. (2011), *The fraud audit: responding to the risk of fraud in core business systems*, Vol. 16, John Wiley & Sons.
- [26] Waterhouse, P. (1985), '*Challenge and Opportunity for the Accounting Profession: Strengthening the Public's Confidence*', Price Waterhouse, 31.

# Influence of Ownership Structure on Systemic Risk of Vietnam Listed Commercial Banks

Vu Thi Thuy Van<sup>a\*</sup>, Phan Trong Nghia<sup>b</sup>, Bui Thi Thuy Anh<sup>c</sup>

<sup>a</sup> National Economics University, 207 Giai Phong street, Hai Ba Trung district, Hanoi, Việt Nam.

<sup>b</sup> Quy Nhon University, 170 An Duong Vuong street, Quy Nhon city, Binh Định province, Việt Nam.

<sup>c</sup> National Economics University, 207 Giai Phong street, Hai Ba Trung district, Hanoi, Việt Nam.

## ABSTRACT

This research use database of listed commercial bank on Vietnam securities market from 2010 to 2014 and the fixed effects model (FEM) to assess the impact of state ownership, ownership of major foreign shareholders, and other ownership of foreign shareholders on systemic risk of listed commercial banks on Vietnam stock market. The results show that there is a non-linear relationship between state ownership and systemic risk of commercial banks in Vietnam. Besides, there is a positive relationship between ownership of major foreign shareholders and systemic risk of commercial banks in researching sample

**Keywords:** Ownership structure, systemic risk, listed commercial banks

## 1. Introduction

Commercial banks play essential roles in transferring capital in the economy, stimulate the economic growth and realize macroeconomic goals of the government. In addition to the increase of size, quantity and quality, the diversification of ownership structure in commercial banks has created a positive development in banking activities in Vietnam. In fact, there are mixed ownership among banks and big corporations which are banks' majority shareholders, which brings certain benefits such as optimizing advantages of branches, technology supporting, technology transferring, joint capital loans, liquidity supporting. However, mixed ownership between banks or joint ownership of banks and other corporations generate systemic risk related to the possibility of liquidity and default risk. Once it happens in a bank, risk can affect other banks and the operation of the whole system. In today industry renovation 4.0, systemic risk will not only impact on operations of banking system but also quickly spread to other industries in the economy. Therefore, maintaining the stability and minimize risk possibility in banking activities in the integration times is one of the top priorities policies in every country.

There are always latent risks in the operation of commercial banks, which can both be caused by macroeconomic factors such as economic growth rate, interest rate, inflation, policies administration of government, and specific factors such as ownership structure, banking administration, technology,... Risks of bank are affected by different factors, especially ownership structure. Through managing ownership structure, operation risks can be decreased or stimulated. Therefore, it is necessary and pivotal to research about impact of ownership structure on systemic risk of listed commercial bank of Vietnam.

There are some relevant papers about how ownership structure affects bank risks worldwide, such as Nocera and Sironi (2007); Shehzad, Haan and Scholtens (2010); Sarairi (2013); Nicolo and Loukoianova (2007) assessing the impact of concentration ownership on bank risks. These researches, though have different conclusions about the relationship between ownership of majority shareholders and risks of banks, claim that ownership structure is the main reason leading to differences in bank risks. About the relationship between state ownership and bank risks, some papers of Paola Sapienza (2002), Beger et al. (2005) pointed out that banks with state ownership often have scale advantage, which lead to a lower interest rate than private banks. However, those banks are considered to be less efficient and create burden to system during equitization. In general, researches show that ownership structure has certain influence

\* Corresponding author. Tel.: +84 904133631.  
E-mail address: thuyvan1507@gmail.com

on risks during the operation of banks.

This paper aims to clarify which factors affect systemic risk of listed commercial banks of Vietnam, and particularly, analyse the relationship and quantify the impact of ownership structure on systemic risk of listed commercial banks. Besides, results of this research, which analyses Vietnam listed commercial banks, also provide more evidences on the relationship between ownership structure and bank systemic risk in a developing country. This paper also imply some suggestions in managing stock commercial banks, especially banks with state ownership, as well as suggestions for investors in analysing and making decisions, and suggestions for State Bank of Vietnam to restrict effect of systemic risk on business activities of Vietnam commercial banks.

## 2. Theories framework and Researching method

### 2.1. Theories framework

#### 2.1.1. Ownership structure

Ownership structure is a key factor of corporation administration which affect the productivities and efficiency of companies. Ownership structure makes stock prices more informative, improve the efficiency in managing firm and qualification of announced information (He et al., 2013). It also contribute to tackle the problem of representative in activities of listed company, to control information asymmetry on stock market, to minimize the cost of getting information as well as transaction expenses of investors.

Ownership, including ownership in commercial banks, is approached by two aspects, ownership concentration – ownership of majority shareholders and ownership mix (Nguyen Hong Son et al., 2015). Ownership of majority shareholders, is entity that owns the greatest percentage of a company's shares and therefore, affects risk possibility and administration expenses of banks. According to research of Rokwaro (2013), ownership concentration is defined as ownership rate of the five largest shareholders in Kenya banks. Wen (2013) also uses ownership concentration rate in commercial state banks and private banks in China as the most majority shareholding rate. Researches of Brockman and Yan (2009); Dang Tung Lam (2016) define majority ownership as shareholders who hold more than 5% over total outstanding share of a firm.

According to researches of Rokwaro (2013), Wen (2013), Anstoniadis et al. (2010), Peong et al. (2012), **ownership mix** contains ownership proportion of state ownership, foreign ownership and private ownership. In this paper, ownership structure is approached through following owning form: state ownership, ownership of foreign majority shareholders and other ownership of foreign shareholders. The impact of ownership structure on systemic risk of commercial banks through **mechanism of firm managing amelioration**. Through ownership structure, banks can be more effective in management (improve risk management, efficiency of operation and clarity in information announcement), which improve both quantity and quality of information of specific firms that is published to investors. As a result, investors can make decisions in valuation and investment basing on this specific information instead of general information of the whole market. Research of Nguyen Hong Son et al. (2015) pointed out that weak company management is one of the factors which lead to crisis in banks system. Therefore, better bank management will reduce systemic risk in banking activities.

#### 2.1.2. Systemic risk in commercial banks

Definition of risk has appeared early in a famous research of A.Willet and F.Knight. In 1901, A.Willet supposed that risk is prospect with relative uncertainty (Willet, 1901) while F.Knight explained the relationship between “risk” and “uncertainty”. He believed that the term “uncertainty” should only be used in circumstances that events cannot be quantified (Knight, 1921). Modern researches on developing risk definition also base on this traditional approach.

Systemic risk is truly concerned and mentioned after the global financial crisis in 2008. It is considered as shocks which negatively affect financial system as well as the whole economy.

In such important entities in the financial system like banks, researching systemic risk is more essential and necessary, which is focused by many researchers worldwide. Adrian and Brunnermeier (2011) suggested using  $\Delta\text{CoVaR}$  to measure systemic risk, as well as illustrated that leverage level, size, and difference in duration are factors impacting the contribution to market systemic risk in financial institutions. Basing on this model, Borri et al. (2014) also estimated systemic risk of Italian listed banks between 2000 and 2011. Despite confirming the advantages and suitability of  $\Delta\text{CoVaR}$  in measuring systemic risk, the authors also suggested that both VaR and CoVaR should be considered to propose appropriate policies.

Besides, Rungporn Roengpitya and Phurichai Rungcharoenkitkul (2011) estimated systemic risk and financial connections, especially in banking system. Their research argued that the origins of systemic risk are: (1) banks efforts to reduce other types of risk but increase systemic risk, (2) bank capital structure contains strong relationship among assets of different bank, (3) the issue of co-management, domino effect and shortage of liquidity. Using  $\Delta\text{CoVaR}$  model for 6 commercial banks in Thailand, the authors analysed the influence of total liabilities, interbank assets, interbank

deposit, interbank debt, ordinary share, re-invest profit and short-term liabilities on systemic risk of those banks. The research concluded that systemic risk will decline if banks co-operate with other industries instead of financial institutions, and size is not the only factor that impact the level of financial links among commercial banks.

### 2.1.3. Influence of ownership structure on systemic risk of commercial banks.

Research of Shehzad, Haan and Scholtens (2010) demonstrated that ownership structure affects bad debt ratio and capital adequacy ratio of commercial banks. It points out that ownership concentration has a positive relation with capital adequacy ratio and a negative relation with bad debt ratio. Particularly when bank's capital is held by several majority shareholders, investing portfolio of bank reveals inefficiency. Concentration ownership of majority shareholders lead to conflicts in benefit of majority shareholders and minority shareholders. Research of Nocera and Sironi (2007) showed that banks with high rate of concentration ownership have better qualified loans, which reduces credit risk and default risk. In a similar point of view, Sarairi (2013) also demonstrate that ownership structure influences the behaviors when facing and accepting risks of banks, and changes in ownership structure is the main reason causes differences in banks' risk. The results pointed out that ownership concentration contributes to diminish liquidity risk and credit risk of banks. On the other hand, paper of Nicolo and Loukoianova (2007) proved a positive relation between ownership concentration and bank systemic risk, and it is even more significant when banks with state ownership own a large financial market share of that country. Besides, banks with state ownership and foreign ownership are more impactful and lower in default expenses than banks with private ownership.

State ownership also impacts risks in lending activities of commercial banks. Documents of Paola Sapienza (2002) illustrated that banks with state ownership often has a lower loan interest rate than private banks. Beside, credit activities of banks with state ownership are also influenced by politic factors, therefore these banks often offer lower interest rate loans to corporations which related to politic organisations controlling these banks. In other words, state corporations often derive lower interest loans than other companies from banks with state ownership. Research of Micco et al. (2004) showed that relation between ownership structure and operation efficiency of a bank is more significant in developing countries than developed ones. They also suggest that banks equitization should be encouraged to increase ownership proportion of foreign investors and private investors in banks ownership structure in order to improve efficiency in operation, increase return on equity and reduce operating expenses. Barry et al. (2011) showed that ownership structure has more considerable effects on private banks than public banks. Beger et al. (2005) investigated on state ownership, foreign ownership and domestic ownership in ownership structure. They found out that banks with state ownership not only have lower profit efficiency but also generate burdens during equitization. Their business performance, however, is improved drastically after equitization.

Researches of Berger et al. (2013) illustrated that ownership structure is one of essential factors in forecasting indexes of losing solvency of banks. The authors also pointed out another important forecasting factor – ownership proportion of men outside a bank – can impact default possibility. If a manager in low position of the hierarchy owns majority shares, default risk can be increased considerably. Besides, shares of member in board of directors who does not have rights in managing the firm, or shares of heads of departments, do not directly affect bank default possibility.

There is only a few researches on ownership structure and its effect on risk of commercial banks in Vietnam banking system. An outstanding paper was conducted by Cornett et al. (2009), which uses date of 16 southeast asian countries, including Vietnam. Banks with majority state ownership are concluded to be more risky and less efficient than other joint stock commercial banks.

## 2.2. Method of research

### 2.2.1. Data Analysing

The sample size is chosen based on the listing time requirements of commercial banks. In particular, the calculation of CoVaR requires that the data sequence be long enough and continuous. Therefore, after the screening process, 6 listed commercial banks were selected for the study.

Data used in this paper contains financial reports of 6 listed commercial banks and their stock prices data on HOSE and HNX from 2010 to 2014. Data is supplied by Stoxplus – a company focusing on gathering and analysing financial data in Vietnam. Following table is a list of banks in research:

**Table 2.1 Listed commercial banks in this research**

Symbol	Title of Bank	Stock exchange
ACB	Asia Commercial Joint Stock bank	HNX
CTG	Vietnam Joint Stock Commercial Bank for Industry and Trade	HOSE

EIB	Vietnam Commercial Joint Stock Export Import Bank	HOSE
STB	Sai Gon Thuong Tin Commercial Joint Stock Bank	HOSE
SHB	Sai Gon Thuong Tin Commercial Joint Stock Bank	HNX
VCB	Vietnam Commercial Joint Stock Bank for Foreign Trade	HOSE

### 2.2.2. Reseaching Variables

This database is processed through Microsoft Excel and then statistic software Stata as an array data model. This paper analyses on correlation, multi-collinearity and descriptive statistics of variables in model. Then, the authors use estimating method in regression model to select from Random Effect Model, Fixed Effect Model and Pooled OLS to regress in Stata.

**Dependent Variable:** Systemic risk ( $\Delta\text{CoVaR}$ )

$\Delta\text{CoVaR}$  measure marginal systemic risk that banks contribute to market systemic risk.  $\Delta\text{CoVaR}$  is measured as below:

#### Step 1: Calculating VaR

In order to measure VaR, we use the approach including systemic risk. This method uses quantile regression model in which independent variables are main macroeconomic factors affecting returns of stock market (Adrian, T. & Brunnermeier, M., 2008).

In this model, return of industries and return of market will be estimated independently basing on 1 year lagged of macroeconomic indexes by following model:

$$Q_d(r_t^i | M_{t-1}) = \alpha^i + \beta^i M_{t-1} + u_t^i$$

$$Q_d(r_t^{\text{system}} | M_{t-1}) = \alpha^{\text{system}} + \beta^{\text{system}} M_{t-1} + u_t^{\text{system}}$$

In this model,  $r$  is return of industry, using quantile regression model, estimating return with  $d = 5\%$ , estimating quantile value 5% of return to get VaR (5%) as the following formula:

$$\text{VaR}_t^i = \alpha^i + \beta^i M_{t-1} + u_t^i$$

$$\text{VaR}_t^{\text{system}} = \alpha^{\text{system}} + \beta^{\text{system}} M_{t-1} + u_t^{\text{system}}$$

#### Step 2: Measure CoVaR using historical data

$$\text{ETL}_{h,\alpha} = -E(r_h | r_h < -\text{VaR}_{h,\alpha}) \times P$$

ETL (expected tail losses) is mean value of losses if damage really happens (losses are higher than calculated VaR),  $\alpha$ : trusted ratio;  $h$ : days of calculating VaR, for example: 5-day VaR, 10-day VaR or 1-year VaR,  $r$ : rate of return, VaR: Value at Risk,  $P$ : Possibility.

Finally,  $\Delta\text{CoVaR}$  is calculated from CoVaR and market VaR as following:

$$\Delta\text{CoVaR}_t^i = \text{CoVaR}_t^i - \text{VaR}_t^{\text{system}}$$

**Independent Variable:** Ownership structure, including:

State ownership through state-owned enterprises (SOEs): similar to research by Hamdi & Cosset (2014), state ownership here is defined as the percentage of shares held by the state in every forms over total outstanding shares of banks. So, state ownership through state-owned enterprises does not cover the percentage of shares held by the State Capital Investment Corporation (SCIC) ownership, State Bank of Vietnam ownership, Ministry of Finance ownership and ownership of other relevant state ministries or organisations.

SOE^2: The SOE^2 variable is introduced into the model to observe the marginal variation level of SOE for  $\Delta\text{CoVaR}$ . Initially, when SOEs begin to increase,  $\Delta\text{CoVaR}$  decreases, to a certain extent, when the SOEs increase, the change in direction causes the  $\Delta\text{CoVaR}$  to increase.

Ownership of foreign majority shareholders (Mforeign): similar to Brockman and Yan (2009); Dang Tung Lam (2016), Ownership of foreign majority shareholders is the ownership percentage of foreign investors who hold more than 5% of total outstanding shares of banks, including both individuals and organisations.

Ownership of other foreign shareholders (Oforeign): is the ownership percentage of other foreigner investors who are not majority shareholders of banks, including both individuals and organisations.

Controlling Variables:

ROE: return on equity, calculated by Earning after tax/Equity of banks in the end of the analysing year.

Leverage: calculated by Total Liabilities/Total Assets of banks in the end of the analysing year.

Basing on the literature reviews, this paper analyse the influence of ownership structure on systemic risk of listed commercial banks in Vietnam, using following regression model:

$$\Delta\text{CoVaR} = \beta_0 + \beta_1 \text{SOEs} + \beta_3 \text{SOEs}^2 + \beta_4 \text{Mforeign} + \beta_5 \text{Oforeign} + \beta_6 \text{ROE} + \beta_7 \text{Leverage} + \epsilon_t$$

### 3. Conclusion and Discussion

#### 3.1. Descriptive statistic and Matrix of correlation

**Table 3.1 Descriptive Statistics of Variables**

Variables	Mean	Standard Dev	Minimum	Maximum
$\Delta\text{CoVaR}$	-0.0183	0.0126	-0.0667	-0.0041
SOES	0.0369	0.0684	0	0.3
Mforeign	0.1436	0.1208	0	0.3
Oforeign	0.0379	0.0409	0	0.1612
ROE	0.0293	0.0310	-0.2050	0.0901
Leverage	0.9160	0.0223	0.7859	0.9542
Số quan sát	144			

Source: Calculation of authors

Table of descriptive statistics illustrates that  $\Delta\text{CoVaR}$  has a negative mean (-0.183), which is the lowest value in all variables. Leverage has a minimum of 78.6% and maximum of 95.4% and the mean value of liabilities over total assets of listed commercial banks in Vietnam is extremely high (91.6%). However, its degree of dispersion is relatively smaller than SOES and Mforeign, which are 0.0684 and 0.1208 respectively. The highest state ownership percentage is 90.7% and the lowest figure is 0%. Ownership of foreign shareholders (including majority shareholders and other foreign shareholders) is limited under 30% charter capital of a Vietnam commercial bank.

In this paper, we test the multicollinearity by VIF. If VIF is larger than 10, that variable has multicollinearity with other independent variables. The test results show that the coefficient  $\text{VIF} = 3.24 < 10$ , so the model does not exist in multipliers.

#### 3.2. Selecting an appropriate model

Initially, the authors used the Hausman test to select either the fixed-effects model (FEM) or the random-effects model (REM) for the data set to be studied. In addition, the author also uses the Hausman test with the sigmamore option (extended standard deviation of the residue) to ensure more selective results.

**Table 3.2 Hausman test result**

	Estimation coefficient		(b-B)	Sqrt(diag(V <sub>b</sub> -V <sub>B</sub> )) S.E
	(b) FE	(B) RE		
SOES	-0.1617	-0.1439	-0.0178	0.0557
SOES <sup>2</sup>	0.4576	0.2600	0.1976	0.1291
Mforeign	0.0136	0.0457	-0.0321	0.0051
Oforein	0.0524	0.0844	-0.0320	0.0336
ROE	0.0203	0.0511	-0.0309	.
Leverage	-0.0315	-0.1284	0.0969	0.0058
Ho: There is no correlation between ui and independent variables				
Chi2(6) = 182.26				
Prob>chi2 = 0.000				

Source: Calculation of authors

**Table 3.3 Hausman test result with sigmamore option**

	Estimation coefficient		(b-B)	Sqrt(diag(V <sub>b</sub> -V <sub>B</sub> )) S.E
	(b) FE	(B) RE		
SOES	-0.1617	-0.1439	-0.0178	0.0732
SOES <sup>2</sup>	0.4576	0.2600	0.1976	0.1874
Mforeign	0.0136	0.0457	-0.0321	0.0081
Oforein	0.0524	0.0844	-0.0320	0.0447

ROE	0.0203	0.0511	-0.0309	0.0062
Leverage	-0.0315	-0.1284	0.0969	0.0288
Ho: There is no correlation between ui and independent variables				
Chi2(6) = 52.29				
Prob>chi2 = 0.000				

Source: Calculation of authors

According to both test results, the p-values of the tests are both 0.000 which is smaller than the statistically significant level, so it is eligible to reject Ho, i.e the choice of the fixed-effects model is appropriate. However, with the initial fixed-effect model, after testing, there is a variation of changed deviation (the results are shown in the table below with the xttest3 test - Modified Wald test ).

**Table 3.4 Test result of a variation of changed deviation**

Ho: $\sigma(i)^2 = \sigma^2$ will all i	
Chi2 (6)	129.43
Prob> chi2	0.000*

(\*) of statistical significance with a level of 5% and 10%

Source: Calculation of authors

Therefore, to ensure a sustainable research model, the authors use a fixed-impact model with the cluster option (idd) (this helps to ensure that the model does not suffer from variation of changed deviation). Results are presented in Table 3.5:

**Table 3.5 FEM result**

$\Delta\text{CoVaR}$	Hệ số ước lượng Estimation coefficient	Robust S.E	t	p> t
SOES	-0.1617	0.0484	-3.34	0.020*
SOES <sup>2</sup>	0.4576	0.1310	3.49	0.017*
Mforeign	0.0136	0.0043	3.15	0.026*
Oforeign	0.0524	0.0406	1.29	0.253
ROE	0.0203	0.0325	0.62	0.560
Leverage	-0.0315	0.0313	-1.01	0.360

(\*) of statistical significance with a level of 5% and 10%

Source: Calculation of authors

The result has shown that SOE, SOE<sup>2</sup> and Mforeign were statistically significant at 10% significance level. The estimation coefficient for variable SOES<sup>2</sup> = 0.4576 > 0 indicates that there is a gradual increase in margin rule, which means that when SOE increases,  $\Delta\text{CoVaR}$  will be reduced, but SOE increases to a certain degree will lead to the increase of  $\Delta\text{CoVaR}$ . The level of this marginal impact is calculated as follows (conditionally that other factors are constant):  $\partial\text{CoVaR}/\partial\text{SOES} = -0.1617 + 0.9152 * \text{SOES}$ .

## 4. Conclusions and researching implications

### 4.1. Conclusions

Using regression model with table data of 6 listed commercial banks on Vietnam stock exchanges from 2010 to 2014, the authors recognise a negative relation between state ownership and systemic risk of commercial banks. Thanks to state ownership, systemic risk of listed commercial banks in Vietnam market has been reduced. This conclusion is appropriate as banks with high proportion of state ownership are said to be highly efficient in business performance, with better risk management,. Also, banks with state ownership play an important role in the operation of the entire banking system in Vietnam and thereby affect the systemic risk of the entire banking system in Vietnam.

In addition, the study also shows that a non-linear relationship between state ownership and systemic risk of banks does exist. This suggests that increasing the initial state ownership proportion has an impact on reducing systemic risk. However, when this proportion exceeds the allowable threshold, it will increase the systemic risk of commercial banks. In Vietnam's market, state-owned commercial banks play an important role and have a strong influence on the functioning of the entire banking system. In addition, commercial banks where the state is one of shareholders dominate

the shareholder ownership of private commercial banks. Such cross-ownership between banks will increase the systemic risk in the operation of the bank. In addition, state-owned corporations and state-owned enterprises are also involved in the purchase and ownership of private commercial banks. It is the form of joint ownership between the bank and businesses that results in increases in systemic risk in the operation of the banking system in Vietnam.

Ownership of majority foreign shareholders has a positive correlation with systemic risk in stock market. In Vietnam, foreign investors are encouraged to hold shares of listed companies as our government enlarge the “room” – owning percentage - for them. However, government still takes control of foreign ownership in listed commercial banks. In Article 7, Decree 01/2014, total ownership proportion of foreign investors is limited under 30% of charter capital of a Vietnam commercial bank. Therefore, foreign investors can be majority shareholders, strategic investors, members of board of directors but do not play essential roles in making important decisions in banking activities (especially in banks with majority state ownership). They can not improve the efficiency in bank’s performance, stimulate risk management or enhance clarity in information announcing. Weakness in risk management will spread over Vietnam banks system and increase systemic risk in banking activities.

#### 4.2. Research implications

The result of quantitative analysing shows that relations between state ownership, ownership of majority foreign shareholders and systemic risk of Vietnam commercial banks are existing and statistically meaningful. Basing on this result, we explain several implications:

State ownership and systemic risk: practical research conclusions and meaningful test results illustrate the negative impact and the existence of non-linear relationship between state ownership and systemic risk of commercial banks. To reduce systemic risk in banking activities, State should encourage divestment and gradually cut down its ownership proportion in commercial banks. The State should concentrate more on its managing and moderating function, which enables the market to operate healthily, transparently and effectively. Directly intervening and joining in controlling and managing banks’ operation should be restrained.

Ownership of majority foreign shareholders: As well as diminishing state ownership proportion, owning percentage of foreign shareholders should be increased under the forms of strategic investors, majority shareholders and organisational investors. State should release policies to encourage foreign organisational investors to buy shares and participate in managing banks. In Vietnam integration tendency, current regulations should be amended to enlarge owning proportion of foreign investors in commercial banks and system of financial institutions should be restructured to enhance efficiency in performance, improve risk management and bad debt solutions.

Besides, banks with large percentage of liabilities and low rate of equity, especially with state ownership, are more vulnerable to systematic risk in the market. Therefore, these banks need to develop their risk management policies, increase clarity in information announcing and reduce mix ownership among banks in Vietnam banking system.

#### References

- [1] Đặng Tùng Lâm, (2016). Ảnh hưởng của cổ đông lớn đến sự đồng biến động giá cổ phiếu trên Sở giao dịch chứng khoán thành phố Hồ Chí Minh. Tạp chí Phát triển kinh tế , số 27(5), 63-77.
- [2] Adrian, T., & Brunnermeier, M. (2011), CoVaR. Working Paper, Federal Reserve Bank of New York.
- [3] Antoniadis I., Lazarides T.M, Sarrianiades N. (2010), Ownership and performance in the Greek banking sector. International Conference on Applied Economics - ICOAE 2010.
- [4] Barry, T. A., Lepetit, L., & Tarazi, A., (2011). Ownership structure and risk in publicly held and privately owned banks. *Journal of Banking and Finance* 5, 1327-1340.
- [5] Beger, A. N., Klapper, L. F., & Zaidi, R., (2005). Bank Ownership type and banking relationship. *Journal of Financial Intermediation* 17, 37-62.
- [6] Berger Allen N, Imbierowicz Björn, & Rauch Christian, (2013). The roles of corporate governance in bank failures during the recent financial crisis. Working paper.
- [7] Borri, N., Caccavaio, M., Giorgio, D., Sorrentino, A., M., (2014), Systemic Risk in the Italian Banking Industry. *Economic Notes*, Volume 43 (1), 21–38.
- [8] Brockman, P., Yan, X., (2009). Block ownership and firm-specific information. *Journal of Banking and Finance*, 33, 308–316.
- [9] Hamdi, B.N., Jean-Claude Cosset, (2014). State ownership, political institutions, and stock price informativeness: Evidence from Privatization. *Journal of Corporate Finance*, 29, 179-199.
- [10] He, W., Li, D., Shen, J., Zhang, B.,(2013). Large foreign ownership and stock price informativeness around the world. *Journal of International Money and Finance* , 36 ,211–230.
- [11] Knight, F. H. (1921). Risk, uncertainty and profit. New York: AM Kelley, 1964.
- [12] Micco, A., Panizza, U., & Yanez, M., (2004). Bank ownership and performance. Econstor.
- [13] Nguyen Hong Son, Tran Thi Thanh Tu, Dinh Xuan Cuong, Lai Anh Ngoc, Pham Bao Khanh, (2015). Impact of Ownership Structure and Bank Performance - An Empirical Test in Vietnamese Banks. *International Journal of*



- Financial Research. Vol. 6, No. 4, pp.123-133.
- [14] Nocera, G., Sironi, A., Iannotta, G., (2007). Ownership structure, risk and performance in European banking industry. *Journal of Banking and Finance* 31, 2127-2149.
- [15] Nicolo, G. D., Loukoianova, E., (2007). Bank ownership, market structure and risk. IMF working paper.
- [16] Paola Sapienza (2002). The effects of Government Ownership on bank lending. *Journal of Financial Economics* 72, 357-384.
- [17] Peong Kwee Kim, Devinaga Rasinah & Rahayu Binti Tasnim (2012). A Review of Corporate Governance: Ownership Structure of Domestic-Owned Banks in Term of Government Connected Ownership, and Foreign Ownership of Commercial Banks in Malaysia. *Journal of Organizational Management Studies*, Vol. 2012.
- [18] Sarairi, S., (2013). Ownership structure and risk-taking behaviour in conventional and Islamic bank: Evidence for MENA countries. *Borsa\_Istanbul Review* 13, 115-127.
- [19] Shehzad, C. T., Haan, J., & Scholtens, B., (2010). The impact of bank Ownership concentration on impaired loans and capital adequacy. *Journal of Banking and Finance* 34,339-408.
- [20] Rokwaro Massimiliano Kiruri (2013). The effect of ownership structure on bank profitability in Kenya. *European Journal of Management Sciences and Economics*, Vol. 1, Issue 2, March 2013.
- [21] Roengpitya, R. & Rungcharoenkitkul, P. (2011). Measuring systemic risk and financial linkages in the Thai Banking system. Social Science Research Network, Last visited on 12/10/2016 at [http://papers.ssrn.com/sol3/papers.cfm?abstract\\_id=1773208](http://papers.ssrn.com/sol3/papers.cfm?abstract_id=1773208).
- [22] Wen, Yuan and Jia, Jingyi (2010). Institutional ownership, managerial ownership and dividend policy in bank holding companies. *International Review of Accounting, Banking and Finance*, Vol 2, No. 1, Spring 2010, page 8-21.
- [23] Willet, A. H. (1901). *The Economic Theory of Risk and Insurance* (repr. 1951). Irwin, Homewood, EL.

International Conference For Young Researchers In Economics And Business, ICYREB 2017, October 30<sup>th</sup> 2017  
Da Nang, Vietnam

# Solutions to Well Attract Vietnamese Customers' Attention to TV Advertising

Nguyen Thi Huyen Tran<sup>a\*</sup>, Nguyen Thi Thu Ha<sup>a</sup>, Ha Hien Minh<sup>a</sup>

<sup>a</sup>Foreign Trade University, Vietnam

## ABSTRACT

Each country has different cultures. Therefore, to design a good TV advertising clip containing enough messages which will persuade watchers to pay attention is very important to firms. This article aims to discover which elements are really essential to be included in TV ads in Vietnam. The research is based on survey results from 303 participants from every age groups combining with analysis by FsCQA software to find out some good solutions which can be effective in attracting customers' attention towards TV advertising programs. Findings imply emotionalism and credibility always accounts for big roles in building attention of Vietnam consumes towards TV advertising. This research can contribute good knowledge to advertising designers of Vietnamese customers' attitude towards TV advertising.

**Keywords:** entertainment, informativeness, emotionalism, credibility, materialism, advertising, solution.

## 1. Introduction

Despite the enormous increase in the recent use of social networking media, mass media is still an important component of modern advertising strategy (Kotler and Keller, 2011). Since the booming of mass media advertising, researchers have conducted different studies and expressed the practical and theoretical importance of consumers' attention toward advertising. Attention toward advertising can be defined as a learned predisposition to respond in a consistently favourable or unfavourable manner toward advertising in general. Consumer's attention toward advertising is crucial because it can predict the way consumers respond to any particular ad (Mehta, 2000), consumers' attention toward the ad, and involvement with specific \* ad (James & Kover, 1992). It can also form consumer's attentions toward a brand and influence consumer's purchase intention.

Among various types of media, television is generally acknowledged as one of the most influential advertising medium which can reach a wide range of consumers at low cost per exposure (Kotler and Keller, 2011). Global spending on TV advertising reached \$203,444 million in 2013 (accounts for approximately 57.6% of total advertising expenditure on main medium) and continued to grow in 2014 (Nielsen, 2013). Because of the domination of TV advertising and the essential of attention toward advertising, there is a need to explore insightful understanding toward TV advertising. By investigating this construct deeply, advertisers can interpret how consumers form attentions toward TV commercials, then, helping them to develop a more effective advertising campaign. People show different attentions toward TV advertising in general, some have negative and others have positive overall attentions. The differences in attention may be due to the diverse demographic of the target audience. Although previous researches have examined attention toward TV advertising in general, most of them are conducted in the American-European axis (Alwitt and Prabhaker, 1994). Focusing on this mainstream does not allow for information judgments regarding the universality of findings (Walters, 2001), especially when there are enormous demographical and cultural differences between various countries.

According to a report of ZenithOptimedia, Vietnam's advertising spending growth during the period of 2011-2014 is estimated to reach approximately \$3,820 million. Growth in advertising expenditure of Vietnam is also predicted as the highest among Southeast Asia countries and Vietnam is expected to be one of the four most fast-growing markets for advertising in the world (ZenithOptimedia, 2012). Among three most common advertising media in Vietnam, spending on TV advertising was the highest one which accounted for 62.6% of total advertising expenditure in 2011

\* Corresponding author. Tel.: +84909828275.

E-mail address: nguyenthihuyentran.cs2@ftu.edu.vn

(Nielsen, 2012). Despite of the increase in spending on TV advertising in Vietnam, there is a lack of research on how the consumer thinks about TV advertising and what mechanism would be effective for TV advertising in this country. Recognizing this shortcoming, this study is designed to examine insights into attention toward TV advertising of Vietnam consumers and its antecedents. Understanding of these issues is critical to enhance the power of advertising, which in turn contributes to the success of corporates' marketing strategy. Prior study has showed that consumers' attention toward TV advertising in general depends on beliefs about TV advertising and functions of TV advertising. Beliefs refer to what people know about TV advertising (for instance, whether it is informative, whether it is deceptive) whereas functions refer to what TV advertising serves viewers and how it fits into their life (e.g., whether it is seen as a source of entertainment). On the basis of these dimensions, this study attempts to investigate the influence of three constructs: entertainment, informativeness emotionalism, credibility and materialism on Vietnamese customers' intention and attention toward TV advertising in general.

This study is structured as follows: first, the literature on attention toward TV advertising and its antecedents are reviewed. This is followed by a description of the research methodology and procedures used in the study. Next, the results are discussed and summarized. Finally, the study offers implications, limitations and directions for further research.

## **2. Literature review**

### **2.1. Customer attention**

Customer attention and customer loyalty have been discussed for decades. Many scholars study about these issues because they are important to firms. For companies, one of the best ways to develop firms' size and market share is to increase their sales as much as possible. Therefore, nowadays every firm also conducts marketing activities, especially advertising programs in which TV advertising is a common choice. The purpose of firms when using TV advertising is to try to attract customer intention or attention on their products. Customer attention can affect the actual purchase or repurchase of a brand (Caruana, 2002), so, if a commercial can attract customers' attention it can initially build up an intention of purchase from those customers. Once well bring customer intention or attention of buying products is established, sellers can easily establish customer repurchase and loyalty in a short future (Mende, Bolton and Bitner, 2013).

### **2.2. Entertainment**

Entertainment element in advertising is defined as "...the ability to fulfil an audience's needs for escapism, diversion, aesthetic enjoyment, or emotional release." (Ducoffe, 1996, p.22). It is believed that the effectiveness of messages on consumers could be increased if advertisers attempt to make advertising more entertaining (Logan, Bright and Gangadharbatla, 2012). The value of advertising lies in its ability to satisfy consumer needs for entertainment, enjoyment, and emotional release. Consumers' feeling of entertainment associated with advertising is proven to be strongly connected with their overall attention toward advertising. This relationship has been investigated in different context such as mobile advertising (Bauer, Tina and J., 2005); (Zabadi, Shura and Elsayed, 2012), internet advertising (Ducoffe, 1996); (Gao and Koufaris, 2006); (Kunz, Hackworth and Osborne, 2011); (Logan, Bright and Gangadharbatla, 2012); (Schlosser, Shavitt and Kanfer, 1999) and TV advertising (Logan, Bright and Gangadharbatla, 2012). For instance, Zabadi et al. (2012) found that there is a positive correlation between consumers' perceptions of the entertainment value of SMS advertisements and consumers' overall attentions towards SMS advertising. Schlosser et al. argued that attention toward internet advertising is affected by enjoyment, informativeness, and the ad's utility for making behavioural (purchasing) decisions (Schlosser et al., 1999). With regard to TV advertising, a previous study showed that perceived entertainment function of television advertising make up consumers' attentions about TV advertising in general. Consumers who perceive the enjoyment function tend to have more favorable attentions toward TV advertising.

### **2.3. Informativeness**

Providing information is one of the essential duties of advertising. Prior researchers have showed that consumers rate informativeness as the single factor most strongly correlated with overall advertising value (Ducoffe, 1995); (Rotzoll et al., 1989). Consumers view the informational value of advertising favorably, although certainly not everybody acknowledged this. Ducoffe defined informativeness as "the ability of advertising to inform consumers of product alternatives so that purchases yielding the greatest possible satisfaction can be made" (Ducoffe, 1996, p.22). Previous advertising research has examined the informativeness of advertising with respect to the usefulness of that information. This usefulness can be explained as the ability of advertising to provide consumers information about new products, specific product benefits and comparative product information (Shavitt, Lowrey and Haefner, 1998). Because the perceptions of advertising usefulness explain a sizeable portion of the variance in overall liking or disliking of

advertising (Shavitt, Lowrey and Haefner, 1998), informativeness can be considered as an important antecedent of attention toward advertising. In regard to TV advertising, researches on this domain have documented the importance of informativeness when consumers perceive and evaluate advertising in general. For instance, Mittal found that among three groups of TV advertising attributes (information, enjoyment and silliness), information contributes the most to overall liking/disliking for advertising. The more consumers perceived the advertising to be informative the more favourably they viewed it (Chittithaworn, Islam and Thooksoon, 2011). In contrast, viewers who see no benefit in TV advertising or believe it is too repetitive are the ones who exhibit a uniformly higher dislike of TV advertising (Alwitt and Prabhaker, 1994).

#### 2.4. Credibility

Advertising credibility is like the consumers' perception of the truthfulness and believability of advertising in general. This perception is crucial to consumers' overall attentions toward advertising (Shavitt, Lowrey and Haefner, 1998) because consumers are not only interested in the ethical and aesthetic aspects but also concerned about the trustworthiness – or credibility – aspect of advertising (Zanot, 1984), which could support their information selection process in the world of misleading information nowadays. Prior studies support the influence of credibility on attention toward advertising of consumers. For instance, (Okazaki, Katsukura and Nishiyama, 2007) claimed that trustworthiness in mobile advertising affects consumers' attentions toward SMS advertising in both significantly and strong manner. This conclusion confirms results of prior studies on mobile advertising (Tsang, Ho and Liang, 2004); (Zabadi, Shura and Elsayed, 2012). Similarly, when it comes to online advertising, consumers tend to have more positive attention toward online advertising if they believe it is credible and trustworthy (Azeem and ul Haq, 2012); (Brackett and Carr, 2001); (Zhang and Wang, 2005).

TV advertising has been characterized as a familiar and trusted medium of communication which played an essential role in people's lives (Chittithaworn, Islam and Thooksoon, 2011). A study conducted by (Prendergast, Po-yan and Derek, 2009) shows that radio, broadcast television and cable television were perceived by the interviewees as the most credible advertising media. Previous research studied the effect of advertising credibility indicated that what people believe about TV advertising and what it does for them influences their attentions about television advertising. Therefore, when consumers perceived the advertising as deceptive they tend to dislike the advertising regardless of the type of media.

#### 2.5. Emotionalism

Heath et al. proved that emotional effect really has a strong relationship with brand notification (Heath, Brandt and Brandt, 2006). Therefore, commercials which convey great surprise and joy to TV watchers can bring about success to producers (Gómez, 2014). In addition, videos with negative content elicit more attention compared with its positive counterpart which was found by Bradley, Angelini, & Lee (Bradley, Angelini and Lee, 2007); Cheng & Riffe (Cheng and Riffe, 2008) and confirmed by (Daignault, Soroka and Giasson, 2013). Furthermore, emotional reaction should be established before processing an advertisement, then, emotion is seen as a gatekeeper for customers' intention and purchase attention. It is completely true to say that emotional content in well-executed commercials can significantly make audiences remember brands and products (Mehta and Purvis, 2006)

### 3. Methodology

“QCA (Qualitative comparative analysis) has to be understood both as a research approach in a broad sense and as an analytical technique in a more narrow sense” (Wagemann & Schneider, 2010). FsQCA is one of the best software tools in computing logical truth tables in order to find out which elements may influence attitude of TV audiences on advertisements. In FsQCA technique, both the casual conditions and outcome are presented using fuzzy set scores (Ragin, 2000) “The fuzzy program allows users to create configurations from single sets coded either dichotomously or fuzzily, to evaluate the sufficiency of these configurations statistically, using a variety of different benchmarks, and to reduce the configurations determined sufficient to their common logical elements” (Longest and Vaisey 2008). QCA examines cases with their different causally relevant conditions (Woodside & Zhang, 2012). Thus, an approach of QCA focuses on defined types of cases for the combination of causal precursors related (Woodside & Zhang, 2012). QCA has three characteristics: equifinality, asymmetric and causal complexity (Woodside & Zhang, 2012); therefore, QCA can be used to identify characteristics of the intervention, practices and assumptions; there can be many pathways to the same outcome, and that is relevant to the aim of this research.

To conduct this research, we employ a combination of quantitative and qualitative comparative analysis (QCA) methods. First of all, basing on literature reviews we design a questionnaire to exploit thinking of TV watchers concerning TV advertising programs and their attention and intention to purchase the advertised products. Sample population of this study is Vietnamese consumers. The survey covers factors affecting Vietnam consumer attention towards TV advertising. The purpose of the study is among five elements: entertainment, informativeness, credibility,

emotionalism and materialism to find the key factors which affect consumer attention the most. 350 questionnaires was delivered directly to some students who study in University in Foreign Trade University, Ton Duc Thang University, Banking University in Hochiminh City randomly, author’s friends who are working in many fields in Hochiminh City as well as some elders who are relative of authors and authors’ friends we received 307 usable feedbacks from participants from October to December, 2016.

In addition to the quantitative analyses, this study takes one step further to secure the results. To verify the results of the quantitative analyses this study employed a second step that is to use qualitative method. More specifically fuzzy-set qualitative comparative analysis (fsQCA) is used to have a better understanding of the finding. There are some reasons that we choose to use QCA. The first motivation that we use qualitative method in this case is because QCA can help us to define causally relevant characteristics, test sufficiency of causal conditions and derive and interpret the results meaningfully. Furthermore, QCA can help analyze and produce many solutions which may take part in making the same outcome (Ragin, 1999). The second reason is that QCA does not require as many restrictive assumptions as techniques such as regression analysis (Seawright, 2005). So, only one prediction that all the five factors are important and play the same role in affecting attention of Vietnam people toward TV advertising is not enough. The third reason for choosing this method is because QCA can provide us enough useful tools for dealing with complex causal hypotheses in terms of necessary and sufficient conditions under the constraint of a medium-sized number of cases (Schneider and Wagemann, 2006). Moreover, QCA is frequently used in comparative social sciences and QCA is effective in analysis to build a framework (Wagemann and Schneider, 2010). In addition, one of the strengths of QCA is that it is fundamentally considered as case oriented, rather than as some middle way between case oriented and variable oriented analysis (Byrne and Ragin, 2009). Thus the results from QCA analysis may be divided into different kinds which are well suited for distinguished cases.

One of the representatives of QCA is fuzzy set. With fuzzy set, researchers can analyze the findings in a way that directly influence their theoretical arguments (Ragin, 2000). Therefore, fuzzy set can help researchers to mill some buried meanings inside an issue. Thus, some very important parts relating to the objects can be discovered deeply. As fuzzy set combines qualitative and quantitative methods (Rihoux and Ragin, 2009), hence, its results can be continuously developed from the information collected by running quantitative analysis. Fuzzy sets forces researchers to ask constructive questions about their cases and to clarify their theories and concepts (Ragin, 2000). So far, QCA, especially fuzzy set shows its ability to examine the potential interdependence and complexity among effects to determine the performance of each combination (Greckhamer, Misangyi and Elms and Lacey, 2008).

Generally, our findings in this research are found out basing on information exploited by using the strengths of quantitative and qualitative method. Quantitative method is used to check in significant and relationships between variables and the qualitative tool is used to build up conceptual frameworks basing on results checked by quantitative tool. Finally, we can design in-depth solution for attracting Vietnam consumers’ attention towards TV advertising (Ragin, Shulman and Weinberg, 2003).

Since the literatures suggest that entertainment, informativeness, emotionalism, credibility and materialisms significantly relate to consumer’s attention toward TV advertising. However, each element has its own characteristics. Therefore, we hypothesize that these five factors will not influence on consumer’s attention towards advertising in the same way.

#### 4. Research result

Using FsQCA the results relating to the combination of affecting factors to Vietnam consumer’s attention towards TV advertising are produced (table 1).

**Table 1. QCA output-intermediate solution**

	Solution 1	Solution 2	Solution 3	Solution 4	Solution 5	Solution 6
Entertainment			●	●		●
Information		●	●	○	○	
Emotionalism	●	●			●	●
Creditability	●	●	●	○	○	
Materialism	○			○	●	●
Raw coverage	0.545	0.722	0.734	0.734	0.510	0.71
Unique coverage	0.002	0.009	0.024	0.015	0.278	0.00
Consistency	0.979	0.969	0.965	0.976	0.975	0.97
Solution coverage	0.84					
Solution consistency	0.932					

Frequency threshold=1; Consistency threshold: 0.98; black circle “●” indicates the presence of causal conditions;

white circle “O” indicates the absence of negation of casual condition; the blank cells present “don’t care” condition.

First of all we can see raw coverage. Raw coverage and solution coverage measure the extent to which the configurations account for the outcome. Raw coverage of all solutions is greater than 40% indicating that the configurations explain a large proportion of purchasing intention. However, solution 2, 3, 4 and 6 show remarkably high configuration to outcome, which mean that solution 2, 3, 4 and 6 are really important for firms’ managers to consider when conducting some TV advertisement.

In addition, intermediate solution for each group offers several consistent paths leading to high attention of consumers toward TV advertising. These configures imply some rules for designing a good TV advertising program. Among the factors, entertainment, emotionalism and credibility are key elements resulting in high attention of consumers. Entertainment is one of the most essential factors which can lead to customers’ attention on the product, where entertainment itself accounts up to 0.743 (in solution 4) for customer’s attention which is explained by details of solution 4 with the consistency of 0.976, the highest consistency among the solutions. Then, in Vietnam market, if firms would like to attract customers by TV advertising the ad clips should contain a good entertainment function. However, when combining with other factors such as emotionalism, informativeness and credibility the efficiency of entertainment will softly be reduced.

As the result in solution 3 and 6 the configuration of these two solutions are 0.734 and 0.711. From table 1 we can see that emotionalism and credibility are key elements of good solutions. However, if it is not carefully designed the advertising clip can have a very low influence on attracting consumers’ attention when the clip contains only emotionalism and credibility as provided in solution 1. As appearance in table 2, informativeness is not a priority as well as an important element to explore attention of the consumers as not any group confirms its position. However, when informativeness combines with emotionalism and credibility, it can lead to a higher effect (comparing raw coverage of solution 1 (0.545) with solution 2 (0.722) and 3 (0.734)). Moreover, young people (less than 30 years old) are the ones who are mostly affected by informativeness, emotionalism and materialism than other groups of age. This information can interpret that Vietnamese young customers are people who pay attention to TV advertising than others.

**Table 2. Number of people who evaluate the factors are the important or very important**

Age group	Entertain-ment	Informativeness	Emotion-alism	credibility	materialism	Quantity
Less than 20	46	66	49	12	49	222
21-30	42	42	29	10	26	149
31-40	31	28	25	11	20	115
41-50	8	10	9	2	12	41
Rather than 50	6	8	7	2	49	72
Total	133	154	119	37	156	

Base on the information in table 2, we conducted calculating relative index to find which age group is the biggest group who consider the factor is important and very important by using the following equation:  $RI = \frac{X_{ij} Q_i}{C_j T}$ , in which:

$X_{ij}$  denotes the number of people in group 1 think that factor j is important or a very important factor to TV advertising.

$C_j$  means total people in all ages think factor j is important or very important factor to TV advertising.

$Q_i$  means the sum of people in age I participating in the survey.

$T$  means total respondents.

The higher point of IR of a factor means people think that factor is the most important element to the success of TV advertising and the results are presented in table 3.

**Table 3. Relative index indicates which age group is the biggest group who consider the factor is important and very important**

Age group	entertainment	informativeness	emotionalism	credibility	materialism
Less than 20	0.89	1.10	1.05	0.83	1.12
21-30	1.07	0.93	0.83	0.92	0.79
31-40	1.15	0.90	1.04	1.47	0.88
41-50	0.91	0.98	1.14	0.82	1.62
Rather than 50	0.97	1.12	1.27	1.17	0.96

This is to suggest advertisers to take note that different age groups will have different interests. Actually, Vietnam young people (less than 20 years old) care much about informativeness and they are influenced the most by materialism while people from 21 to 30 years old pay much interest to the entertainment of the advertising message. Among above five groups, the element of emotional feature in advertising significantly affect behaviour of people from 31-40 than others.

Since this, we can understand that each factor has different usage in attracting consumers' attention through TV advertising programs. Different age groups evaluate the effect of advertising clips differently. So, the advertisers should consider carefully the time scheme of TV watchers to launch suitable advertising message to maximize benefits and minimize costs. By this framework, we can say that:

First, materialism even has a soft effect on leading to purchase intention after they see some advertising on TV. However, materialism will not influence on Vietnamese consumers' intention or attention of purchase or repurchase of some products.

Second, to make people pay much attention to a product through a TV advertising method it requires the message to contain a good entertainment idea which can make the watchers feel relaxed, funny and happy, otherwise, the advertising message should carry full information about the products including usage, using direction as well as all good and bad sides and emotional ideas so that consumers can not be confused and loose time in thinking, considering of procurement. A TV advertising clip provides enough information and brings about entertainment purpose to consumers and designed in a touching way will make people be interested in watching again many times, and of course, the image of advertised products will firstly appear in consumers' mind when they intend to buy that kind of goods.

Third, creditability of an advertising message will lead to the belief and trust of consumers. For people who have never bought a product, their decision to buy or not to buy that product after watching its advertising message on TV depends much on their trust. If people believe that product is good and value for money, they can buy otherwise if people feel doubtful and unsatisfactory of some information, they may refuse trying, which means people may not buy that product in the future. Similarly, irritation is the feedback of TV watchers after seeing advertising messages; some advertising may contain emotional idea which can make people annoyed or uncomfortable. Emotional messages may leave a deep impression in watchers' memory; however, these kinds of messages may leave a painful feeling. So, if the messages are not cleverly and sophisticatedly designed they may return a very bad effect from audiences. Surely, people will not be irritable and believe on some things without affecting factors. In this research, we can see objective elements as entertainment and informativeness are the causes which contribute to consumers' behaviours towards their attention when watching TV advertisings.

## 5. Discussions and conclusions

The purpose of this research is to find out a conceptual framework of factors affecting Vietnam consumers' attention towards TV advertising. Our findings suggest that even researches of previous scholars draw up 5 main factors affecting attention of consumers towards TV advertising, but those factors do not play the same role as well as position in the success of attracting Vietnam consumer's attention. Moreover, the time of watching does not influence entertainment, informativeness, irritation, creditability and materialism. The same situation of the age of TV watchers in terms of entertainment, informativeness, irritation, however, age groups still has effect on creditability and materialism which means people at different age will have different points of view concerning believability and beneficial messages.

Above findings imply emotionalism and creditability always accounts for big roles in building attention of Vietnam consumes towards TV advertising. This encourages TV advertising designers to pay attention on these two factors: emotionalism and creditability to well attract more consumers to buy their advertised products. So, if the advertisers can explore this feature effectively in their advertising program they will easily get good results.

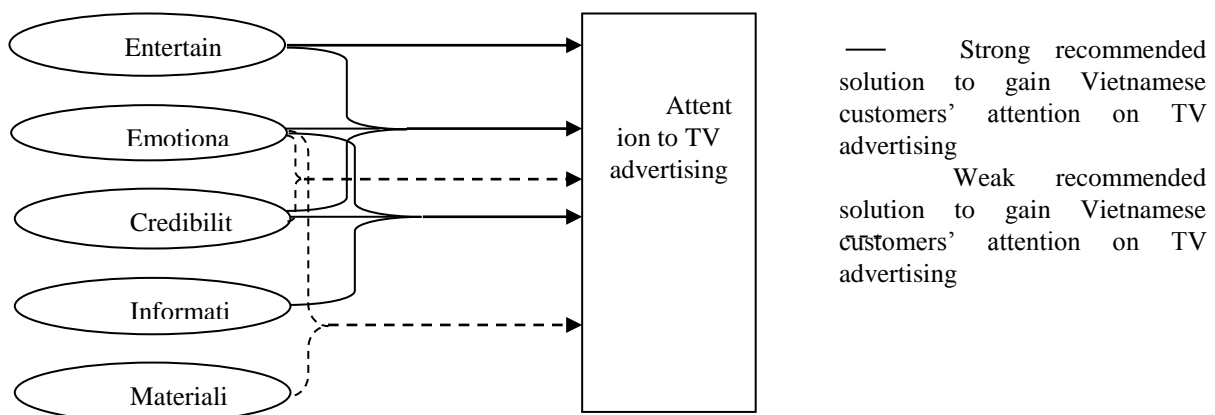

**Figure 1. Framework of factors affecting attention of Vietnam consumers' attention toward TV advertising**

Coming back to table 1, we may find that four solutions show raw coverage around seventy, which is quite high, therefore are reliable. This article implies that there many combination which can be included in a TV advertising to attract Vietnamese consumers' attention towards TV advertising. However, there must be some hidden factors which can affect Vietnamese customers' intention or attention on purchase advertised products. We hope, later researches can follow this implication to find out other sunken elements.

## References

- [1] Alwitt, L. F., & Prabhaker, P. R. (1994). Identifying who dislikes television advertising: Not by demographics alone. *Journal of Advertising Research*, 34(6), 17-29.
- [2] Azeem, A., & ul Haq, Z. (2012). Perception towards Internet Advertising: A Study With Reference to Three Different Demographic Groups. *Global Business and Management Research*, 4(1), 28-45.
- [3] Bauer, R., Tina, B., J., S., & Neumann, M. M. (2005). Driving Consumer Acceptance of Mobile Marketing: A Theoretical Framework and Empirical Study. *Journal of Electronic Commerce Research*, 6(3), 181-191.
- [4] Brackett, L. K., & Carr, B. N. (2001). Cyberspace advertising vs. other media: Consumer vs. mature student attitudes. *Journal of Advertising Research*, 41(5), 23-32.
- [5] Bradley, S. D., Angelini, J. R., & Lee, S. (2007). Psychophysiological and memory effects of negative political ads: Aversive, arousing, and well remembered. *Journal of Advertising*, 36(4), 115-127.
- [6] Byrne, D., & Ragin, C. C. (2009). *The SAGE Handbook of Case-Based Methods*. London: The SAGE publications Ltd.
- [7] Caruana, A. (2002). Service loyalty: The effects of service quality and the mediating role of customer satisfaction. *European Journal of Marketing*, 36( 7/8), 811 - 828.
- [8] Chan, K. (2006). *Advertising and Hong Kong Society*. Hong Kong: The Chinese University Press.
- [9] Cheng, H., & Riffe, D. (2008). Attention, perception, and perceived effects: Negative political advertising in a battleground state of the 2004 presidential election. *Mass Communication & Society*, 11(2), 177-196.
- [10] Chittithaworn, C., Islam, M. A., & Thooksoon, O. (2011). Belief Dimensions and Viewer's Attitude towards TV Advertising in Thailand. *International Journal of Marketing Studies*, 3(1), 95-102.
- [11] Daignault, P., Soroka, S., & Giasson, T. (2013). The Perception of Political Advertising During an Election Campaign: A Measure of Cognitive and Emotional Effects. *Canadian Journal of Communication*, 38( 2), 167-186.
- [12] Ducoffe, R. H. (1996). Advertising value and advertising on the Web. *Journal of Advertising Research*, 36(5), 22.
- [13] Gao, Y., & Koufaris, M. (2006). Perceptual Antecedents of User Attitude in Electronic Commerce. *Database for Advances in Information Systems*, 37(2/3), pp. 42-50.
- [14] Gómez, A. D. (-2014). The Key Elements of Viral Advertising From Motivation to Emotion in the Most Shared Videos. *Education Research Journal*, 43(22), 199-206. doi: <http://dx.doi.org/10.3916/C43-2014-20>
- [15] Greckhamer, T., Misangyi, V. F., Elms, H., & Lacey, R. (2008). Using Qualitative Comparative Analysis in Strategic Management Research. *Organizational research methods*, 11(4), 695-726.
- [16] Heath, R., Brandt, D., & Brandt, D. (2006). Brand Relationships: Strengthened by Emotion, Weakened by Attention. *Journal of advertising research*, 46(4), 410-419.
- [17] Kotler, P., & Keller, K. L. (2011). *Marketing Management 14th edition*. Prentice Hall.
- [18] Kunz, M. B., Hackworth, B., Osborne, P., & High, J. D. (2011). Fans, Friends, and Followers: Social Media in the Retailers' Marketing Mix. *The Journal of Applied Business and Economics*, 12(3), 61-68.
- [19] Logan, K., Bright, L. F., & Gangadharbatla, H. (2012). Facebook versus television: advertising value perceptions among females. *Journal of Research in Interactive Marketing*, 6(3), 164-179.
- [20] Mehta, A. (2000). Advertising Attitudes and Advertising Effectiveness. *Journal of Advertising Research*, 40(3), 67-72.
- [21] Mehta, A., & Purvis, S. C. (2006). Reconsidering Recall and Emotion in Advertising. *Journal of advertising research*, 46(1 ), 49-56.
- [22] Mende, M., Bolton, R. N., & Bitner, M. J. (2013). Decoding Customer-Firm Relationships: How Attachment Styles Help Explain Customers' Preferences for Closeness, Repurchase Intentions, and Changes in Relationship Breadth. *Journal of Marketing Research*, 50(1), 125-142.
- [23] Nielsen. (2012). The Asian media landscape is turning digital. How can marketers maximise their opportunities?
- [24] Nielsen. (2013). Global Ad Spend: With Double Digit Gains, Display Ads Drive In-Your-Face Results.
- [25] Okazaki, S., Katsukura, A., & Nishiyama, M. (2007). How Mobile Advertising Works: The Role of Trust in Improving Attitudes and Recall. *Journal of Advertising Research*, 47(2), 165-178.
- [26] Prendergast, G., Po-yan, L., & Derek, T. Y. (2009). A Hong Kong study of advertising credibility. *The Journal of Consumer Marketing*, 26(5), 320-329. doi:
- [27] Ragin, C. C. (1999). Using qualitative comparative analysis to study causal complexity. *Health Services Research*, 34(5), 1225-1239.
- [28] Ragin, C. C. (2000). *Fuzzy-set Social Science*. Chicago: University of Chicago Press .
- [29] Ragin, C. C. (2000). *Fuzzy-set Social Science*. Chicago: University of Chicago Press.
- [30] Ragin, C. C., Shulman, D., Weinberg, A., & Gran, B. (2003). Complexity, Generality, and Qualitative Comparative Analysis. *Field Methods*, 15(4), 323-340.
- [31] Rihoux, B. (2006). Qualitative Comparative Analysis (QCA) and Related Systematic Comparative Methods: Recent Advances and Remaining Challenges for Social Science Research. *International Sociology*, 21(5), 679-



706.

- [32] Rihoux, B., & Ragin, C. C. (2009). *Configurational comparative methods*. California: SAGE Publications, Inc.
- [33] Schlosser, A. E., Shavitt, S., & Kanfer, A. (1999). Survey of Internet users' attitudes toward Internet advertising. *Journal of Interactive Marketing*, 13(3), 34-54.
- [34] Schneider, C. Q., & Wagemann, C. (2006). Reducing complexity in Qualitative Comparative Analysis (QCA): Remote and proximate factors and the consolidation of democracy. *European Journal of Political Research*, 45(5), 751–786.
- [35] Seawright, J. (2005). Qualitative comparative analysis vis-à-vis regression. *Studies in Comparative International Development*, 40(1), 3-26.
- [36] Shavitt, S., Lowrey, P., & Haefner, J. (1998). Public attitudes toward advertising: More favorable than you might think. *Journal of Advertising Research*, 38(4), 7-22.
- [37] Soh, H., Reid, L. N., & King, K. W. (2007). Trust in different advertising media. *Journalism and Mass Communication Quarterly*, 84(3), 455.
- [38] Tsang, M. M., Ho, S.-C., & Liang, T.-P. (2004). Consumer Attitudes Toward Mobile Advertising: An Empirical Study. *Int. J. Electron. Commerce*, 8(3), 65-78.
- [39] Wagemann, C., & Schneider, C. Q. (2010). Qualitative Comparative Analysis (QCA) and Fuzzy-Sets: Agenda for a Research Approach and a Data Analysis Technique. *Comparative Sociology*, 9(3), 376 – 396.
- [40] Zabadi, A. M., Shura, M., & Elsayed, E. A. (2012). Consumer Attitudes toward SMS Advertising among Jordanian Users. *International Journal of Marketing Studies*, 4(1), 77-94.
- [41] Zano, E. (1984). (). Public Attitudes Towards Advertising: The American Experience. , , *International Journal of Advertising*, 3(1), 3-15.
- [42] ZenithOptimedia. (2012). Global Advertising Growth Continues as Latin America and Asia Pacific Compensate for Weakening Europe, Advertising Expenditure Forecasts. Retrieved from <http://www.zenithoptimedia.com>
- [43] Zhang, P., & Wang, C. (2005). An Empirical Study on Consumers Perceived Value and Attitude Advertising. *Global Information Technology and Management (GITM) World Conference*, Anchorage, Alaska.

# Influence of Share Repurchases on Profitability– A Case Study of Taiwan and Implication

Nguyen Thi Huyen Tran\*, Nguyen Thi Thu Ha, Nguyen Duc Vinh

Foreign Trade University, Vietnam

## ABSTRACT

Nowadays share repurchase is one of the important methods that firms' managers usually use to pay-out investor's total return besides traditional cash dividend. Although share repurchases contain some risks however this method also creates some benefit to investors. Therefore, considering the trade-off between advantages and disadvantages, many firms still conduct share repurchases in some cases, especially to protect investors' profit. Taiwan is one of countries where initially prohibited share repurchases but has just approved share repurchases transaction for about two decades. This market should present some representative performance which helps researchers, especially investors and firms' managers to conduct this method. By using information of 3,648 companies on the TEJ database from 2002 to 2013 to analyse, we would like to exam actual impact of share repurchases on firms' profitability. The results suggest that share repurchases really help to increase profitability of the firms, especially the improvement of ROA, ROE and profit margin.

**Keywords:** ROA, ROE, Profit margin, influence

## 1. Introduction

Almost every one also wants to do some kind of business, some people will start their own business, some will find a job and work as an employee in some company, and others would like to invest in some firms under the role of capital contributors or investors, shareholders. For the investors, when they contribute their money to a firm, they always want to increase their capital as much as possible. After a certain period of time, normally a fiscal year, the firm where shareholders invest will make a final statement and report, and shareholders can receive interest form their investment. The interest can be paid under dividend or otherwise investors may repurchase the firm's stocks as a form of reinvestment. According to Berman's viewpoint of share repurchase: "repurchase of shares leads to a reduction in the shareholders' investment in the firm and will lead to an increase in the ratio of debt to total stockholders' equity employed" but in return, share repurchase can help to increase finance leverage (Bierman, 2001), so, many companies are financing stock repurchases through the issuance of debt (Hurt, Kreuze, & Langsam, 2008). Therefore, share repurchase is one of popular methods by which companies deliver profits and interests to their shareholders.

Taiwan is one of the countries where initially and formerly prohibited stocks repurchases in the 1990s but recently switched to allow resident firms to repurchase equity in the open market (Grullon & Ikenberry, 2003). Almost all firms in Taiwan are controlled by families or business groups (Lin, Liu, You, & Shiu, 2012). Therefore, we would like to research how share repurchases have been affecting profitability of Taiwanese resident firms after share repurchase provisions were applied as one of dividend policy in Taiwan. We will use data form these two industries to analyse the influence of share repurchase on profitability. Therefore, this research is to study the performance of share repurchase in these two fields as well as the influence of share repurchases of companies to the development of the industries as well as the Taiwan market. We will figure out some suggestions to managers when they decide to use share repurchase as the firm's policy.

\* Corresponding author. Tel.: +84909828275

E-mail address: nguyenthihuyentran.cs2@ftu.edu.vn

## 2. Literature review

Nowadays, share repurchase is becoming a popular way to pay-out investor's total return although this method reveals higher risks than traditional paying type-dividend in cash paying (Weigand & Baker, 2009). Because return paying by cash dividend and share repurchases have different advantages, so, when deciding a method of payment, firm's managers will carefully consider how to gain the highest benefits for both firms and individuals. In some cases, dividend will be better but in some other cases a share repurchase deal will result higher benefits (Bierman, 2001). Bierman, in his book suggested that when deciding share repurchase or corporation, real investment, investors should calculate and compare corporate after tax return and investor after tax return, if corporate after tax return is higher than investor after tax return a share repurchase will not be a good choice. In addition, interest rate is also an element an investor should consider to choose share repurchase or real investment (Bierman, 2001). The decision of pay-out by share repurchases or dividend mostly depends on the structure of firms and tax regulations (Jonga, Dijkb, & Veld, 2003). Following, like other researchers, Bozanic also affirmed there are two common ways by which firms distribute cash to shareholders: through dividend and share repurchase. Furthermore, firms in competitive industries tend to repurchase less (Bozanic, 2010).

Accompanying with other scholars' researches, Indro and Larsen (1996) found that the higher quality the company has the more share repurchase transactions will be done. This means when a firm conducts stock buying back transaction, that firm's activity is on the way of development (Indro & Larsen, 1996). However, investor's thought of repurchasing is quite different depending on culture and regulations. In some countries, investors will buy back stocks when they undervaluation their firm (Grullon & Ikenberry, 2000), but in other places, buying back shares means an expectation of firm's growth (Hackethal & Zdantchouk, 2006).

Because of efficiency of the capital market, some markets have weak form of efficiency or semi-strong efficiency, so, many corporate insiders trade passively around repurchase announcements in accordance with their perceived undervaluation to exploit the long-run abnormal stock returns related to the events (Leng & Zhao, 2012). Obviously, significant abnormal returns to a trading strategy actually bases on unrealized gains or losses on accelerated share repurchases (ASR) transactions (Dickinson, Kimmel, & Warfield, 2012). For the firm, share repurchases are not always supported by operating performances but can be used as means to pursue private benefits of the controlling shareholders (Grullon & Michaely, 2004) (Kim, Jo, & Yoon, 2013). Actually, share repurchase has a close relationship with market-to-book (Cheng & Lin, 2012) and Earnings per Share (EPS) (Evans & Evans, 2001), (Ross, Westerfield, & Jordan, 2008) and is positively associated with the values of stock options granted but negatively associated with expenditures on research and development and long-term investments (Bhargava, 2013).

Not only focusing on the benefits, investors, in some circumstances, may buy back shares as a method of reinvest to help the firm reduce the probability of bankruptcy (Sinha, 1991). Therefore, repurchase is more effective as a deterrent when it alters the marginal shareholders who have different basic values and ability to evaluate firm's performance (Bagwell, 1991). Besides, actual repurchases, and not announcements can be harmful to future performance improvements of a firm as well as investors (Lie, 2005). Ahn and his co-authors stated that share repurchase may tender a temporary reduction in the bid-ask spread and a temporary increase in volume and quotation depth during the offer period of trading (Ahn, Cao, & Choe, 2001).

As mentioned before, the numbers of companies which use repurchase stocks as usual method of pay-out investment benefits are increasing. However, comparing to large scale companies, small and value firms are more favourable to repurchase shares, especially when stock price falls (Zhang, 2005), (Kim J. , 2007). One of the rationales of increase is the use of share repurchase is to finance an acquisition, share risk, counteract the negative effects of dilution, and enjoy a tax advantage for their efforts (Wilber, 2007). For other purposes, firms in the growth stage tend to announce a repurchase program to signal its undervalued stock whereas a firm in the mature stage is prone to buy back shares to dispense excess free cash flow (Liang, Chan, Lai, & Wang, 2013). One other reason is that share repurchase even only announcement can also help to improve firms operating performance (Lie, 2005)

To make the firm to be more profitable in future, managers normally weaken earnings growth prior to open-market repurchases and after the transaction period, an improvement in operating performance will appear (Gong, Louis, & Sun, 2008). One of the reasons why share repurchase is used more recently is that it can benefit shareholders when managers really under value their firm (Lie, 2004). For shareholders, a growth in share value will be an appropriate prospect which they always look for (Michaluk, 2007). That is also a rational why firms with significant repurchases during the announcement quarter tend to repurchase more shares in subsequent quarters than firms with no repurchases during the announcement quarter and convey information about future performance (Lie, 2005).

In addition, as Ross and his co-authors mentioned in the his book that one of the most important reasons that shareholders refer share repurchases rather than dividend cash is because of tax treatment, investing in stock is good choice for the money and it causes earning per share (EPS) to increase (Ross, Westerfield, & Jordan, 2000). Moreover, because managers use share repurchases to signal their optimism about the firm's prospects to the market, to avoid having to make larger adjustments in their leverage ratio, can help to improve liquidity (Grullon & Ikenberry, 2003). The benefits of share repurchases are added by the motive to fend off takeovers and counter the dilution effect of stock options (Ritter, 2005). In return, repurchases firms can make some benefits to long-term investors, especially through

abnormal returns (Cheng & Lin, 2012).

### 3. Methodology

Results of this article are conducted by examining data of 3,648 Taiwanese companies which are listed in the TEJ database during the period from 2002 to 2013. All the company date must fit the requirement that there is at least 60 continuous data entries during firm's operation. Moreover, for share repurchases date, we used the date when the firms' board of management decides the transaction. To analyse the effect of share repurchases on profitability of firms, returns of assets (ROA), returns of equity (ROE) and profit margin will be used to represent. First of all, we collected the share repurchases date of all the firms and after that we collect all quarterly ROA, ROE and profit margin of these companies. Quarterly ROA, ROE and profit margin will be averaged. Because firms' managers usually under-evaluate their firms' values, we first hypothesized that abnormal returns (AR) are positive after share repurchases and cumulative abnormal returns (CAR) are significantly positive accordingly. For average AR and CAR, we set the estimated period from -210 to -31 days before share repurchases date and the event period from -30<sup>th</sup> to +30<sup>th</sup> date.

At the same time, ROA is assumed to positively increase following share repurchases. In addition, ROE also grows after share repurchases transaction. The last hypothesis is that profit margin raise after share repurchase. By examining the figures, we conclude the trend of effect of share repurchases on firms' profitability. Then, results will be interpreted to show the impact of share repurchases on firms' profitability. After all, a T-test will be used to check the reality of differences between periods around share repurchases program.

#### 3.1. Research results

With all collected data we calculated some statistics to know more about the average AR and CAR of firms and their performance during the research time. The results of these statistics are displayed in table 1, table 2 and figure 1 below.

**Table 1: Average abnormal return of the period from 2002 to 2013**

Share repurchases date	AR	Share repurchases date	AR
-30	-2.1847**	+1	0.0244
-29	-1.031	+2	-0.1459***
-28	-3.454***	+3	-0.1227***
-27	-2.8441***	+4	-0.073**
-26	1.0991	+5	0.0009
-25	0.4534	+6	-0.17***
-24	-2.3256**	+7	-0.1246***
-23	-1.8763*	+8	-0.1172***
-22	-0.3603	+9	0.106***
-21	-0.5878	+10	-0.1141***
-20	1.1207	+11	-0.0941**
-19	-1.8313*	+12	-0.1534***
-18	0.6903	+13	0.1082***
-17	1.3895	+14	0.1527***
-16	-0.8565	+15	-0.0147
-15	-0.9969	+16	0.0743**
-14	-3.0237***	+17	-0.0288
-13	-1.3622	+18	0.0208
-12	2.4547**	+19	-0.0688*
-11	0.0079	+20	0.0146
-10	-1.4923	+21	0.0543
-9	-0.8165	+22	-0.0395
-8	-2.5415**	+23	-0.0568
-7	-2.1117**	+24	0.051
-6	-0.2246	+25	0.0507
-5	-1.791*	+26	-0.0694*
-4	-0.3208	+27	0.2432***
-3	-1.313	+28	0.1328***
-2	-1.3018	+29	0.1793***
-1	-2.8741***	+30	0.1204***
+0	-1.2427		

**Table 2: Average Cumulative abnormal returns from 2002 to 2013**

Share repurchases period	CAR	Share repurchases period	CAR
CAR (-30,-30)	-0.0902**	CAR (-30,1)	-1.1523***
CAR (-30,-29)	-0.1317**	CAR (-30,2)	-1.2982***
CAR (-30,-28)	-0.2691***	CAR (-30,3)	-1.4209***
CAR (-30,-27)	-0.3792***	CAR (-30,4)	-1.494***
CAR (-30,-26)	-0.336***	CAR (-30,5)	-1.4931***
CAR (-30,-25)	-0.3189***	CAR (-30,6)	-1.6631***
CAR (-30,-24)	-0.4044***	CAR (-30,7)	-1.7877***
CAR (-30,-23)	-0.4731***	CAR (-30,8)	-1.905***
CAR (-30,-22)	-0.4861***	CAR (-30,9)	-1.799***
CAR (-30,-21)	-0.5074***	CAR (-30,10)	-1.9131***
CAR (-30,-20)	-0.466***	CAR (-30,11)	-2.0072***
CAR (-30,-19)	-0.5323***	CAR (-30,12)	-2.1606***
CAR (-30,-18)	-0.5071***	CAR (-30,13)	-2.0524***
CAR (-30,-17)	-0.4564***	CAR (-30,14)	-1.8997***
CAR (-30,-16)	-0.4877***	CAR (-30,15)	-1.9144***
CAR (-30,-15)	-0.525***	CAR (-30,16)	-1.8401***
CAR (-30,-14)	-0.6387***	CAR (-30,17)	-1.8689***
CAR (-30,-13)	-0.6886***	CAR (-30,18)	-1.8481***
CAR (-30,-12)	-0.5991***	CAR (-30,19)	-1.9169***
CAR (-30,-11)	-0.5988***	CAR (-30,20)	-1.9023***
CAR (-30,-10)	-0.655***	CAR (-30,21)	-1.848***
CAR (-30,-9)	-0.6844***	CAR (-30,22)	-1.8875***
CAR (-30,-8)	-0.7729***	CAR (-30,23)	-1.9444***
CAR (-30,-7)	-0.8475***	CAR (-30,24)	-1.8933***
CAR (-30,-6)	-0.8554***	CAR (-30,25)	-1.8427***
CAR (-30,-5)	-0.9199***	CAR (-30,26)	-1.9121***
CAR (-30,-4)	-0.9311***	CAR (-30,27)	-1.6689***
CAR (-30,-3)	-0.9776***	CAR (-30,28)	-1.5361***
CAR (-30,-2)	-1.0257***	CAR (-30,29)	-1.3568***
CAR (-30,-1)	-1.1303***	CAR (-30,30)	-1.2364***
CAR (-30,0)	-1.1767***		

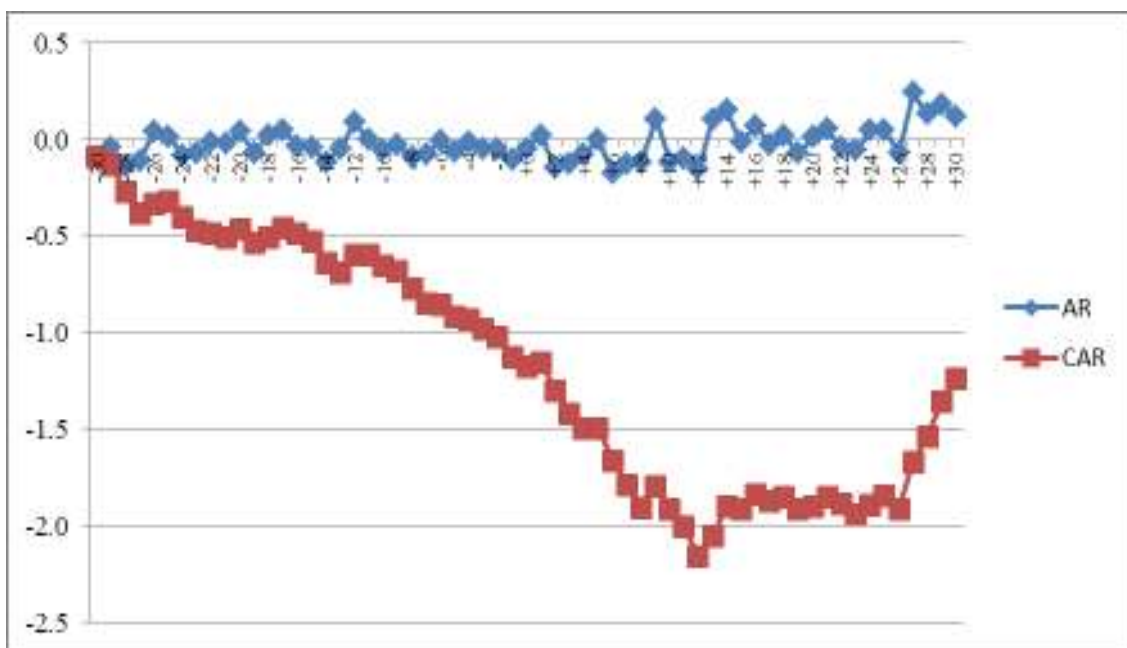

**Figure 1: Trend of abnormal returns and cumulative abnormal returns from 2002 to 2013**

Above table 1 and table 2 show during 30 days before share repurchases, almost all abnormal returns are significantly negative and fluctuated. Besides that, the -12th date is the day when AR shows positive before share repurchases. After share repurchases, there was some improvement in AR, the number of positive-value ARs increased and the father from share repurchases date the more positive value the ARs received. This performance may be because there are some latent ratios from special characteristics of the Taiwanese stock market. In terms of the time, during event period, not all the dates influence on AR but only some days. Information in table 1 also expresses that AR is significant continuously affected by share repurchases only from after the decision of board of management.

As for CAR, different from AR, CAR is consistently influenced by share repurchases of all the time during -29th to +30th date. CAR reduced continuously from the -30th date until the +11th date. After the 11th date after share repurchases CAR strongly recovered despite there was a soft reduction on the 24th date.

Overall, through this information we can know that, share repurchases, are decided by the board of management but still not announced to or really act in the market, also result a significant improvement of the firms performance. Therefore, actual impact of share repurchases on profitability will be deeply discussed by information in table 3, table 4 and figure 2.

**Table 3: Average ROA, ROE, profit margin before, after and in quarter of share repurchases**

Items	ROA	ROE	Profit margin %
Before share repurchases	3.125	4.698	4.747
Event quarter	4.510	7.119	12.743
After Share repurchases	7.155	11.088	13.877

**Figure 2: Average ROA, ROE and Profit margin**

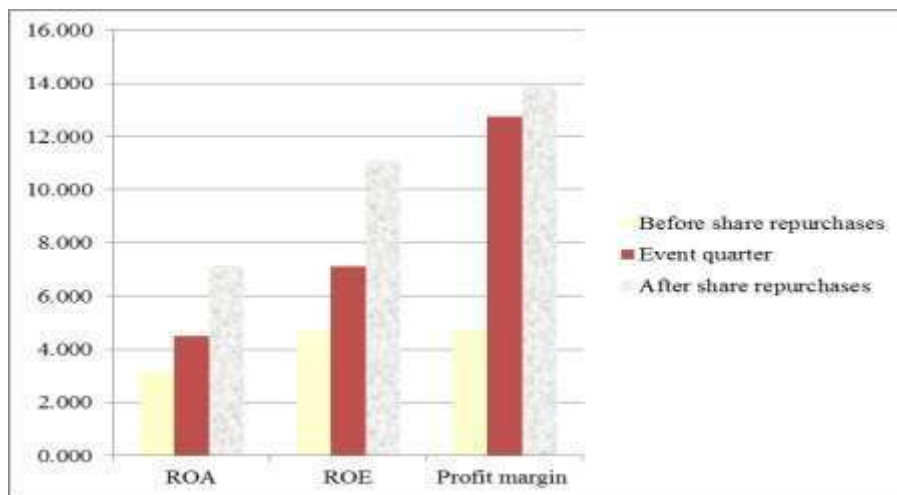

Information in table 3 and figure 2 show that share repurchases really have a significant relationship with ROA, ROE and profit margin. In detail, in the quarter of share repurchase, all ROA, ROE and profit margin are much higher than those before share repurchases. The same situation for after share repurchase date, ROA, ROE and profit margin are also greater than those in share repurchases quarter. This implies that share repurchases were really good for Taiwanese firms because this event can help to increase firm's profitability. In addition, below table 2 will give us more details about the average growth of ROA, ROE and profit margin of Taiwanese firms from 2002 to 2013.

**Table 4: Comparison between before, after and in quarter of share repurchases**

Items	ROA	ROE	Profit margin
Event quarter vs. before event	1.443	1.515	2.685
T-test value	5.95**	2.07*	0.99
After event vs. event quarter	1.586	1.558	1.089
T-test value	2.67**	3.46**	0.41
After event vs. before event	2.290	2.360	2.924
T-test value	4.04**	1.55	0.42

It is clearly that the growth of ROA in share repurchases quarter is about 1.4 times of ROA before firms do share repurchases in table 4. However, after share repurchases, this item was increased much more higher (about 1.6 times comparing to average ROA in share repurchases quarter and 2.3 times vs. ROA of the period before share repurchases). As for ROE, the increasing degrees are relatively similar to ROA. ROE of share repurchases quarter is 1.5 times of ROE in previous quarter. Moreover, and ROE for the quarter after share repurchases is around 1.6 times to the RE of

share repurchases quarter and about 2.4 times in comparison with ROE in the quarter before share repurchases quarter.

The same trend with ROA and ROE, profit margin also experiences a remarkable increase during and after share repurchases. Therefore, during the quarter of share repurchases, profit margin grew 2.7 times corresponding to one quarter before the event. However, after share repurchases, profit margin did not show a great increase but only 1.1 times comparing to share repurchases quarter. Meanwhile, it was still much better than the profit margin in the quarter before share repurchases quarter up to 2.9 times. T-test result shows that there is significant improvement of ROA and ROE during the periods of repurchase program but this is not true with any profit margin.

### 3.2. Discussion and implication

While Lie (2005) documented that operating performance improves following share repurchase program, this article shows that Taiwan is one of the excuses because there was not any improvement of CAR after share repurchases announcement. However, with data from 3,648 of Taiwanese listed enterprises we can conclude that share repurchase even has not been announced or acted but only in decision is also one method which helps companies show their profitability. Profitability is one of the key elements to attract investors to invest in a company. Hence, which ways can increase profitability should be taken into usage by managers to develop their firms. Although AR and CAR did not show positive value after share repurchases but ROA, ROE and profit margin highly increased. Thus, we conclude that firms should conduct share repurchases, even if there is no share repurchases announcement or actual share repurchases. However, only ROA and ROE have strong relationship with share repurchases, but, improvement of profit margin does not significantly depend on a share repurchases program. Then, if companies would like to increase profit margin, share repurchase is not an optimal method to reach the goal. This implies that firms can see share repurchase as a strategic solution to increase firms' performance. However, share repurchase does not make a firm profitable continuously but only a temporary solution. Thus, effective strategic management and efficiency operation are two of important factors which help firms sustainably development. Hence, firms should not change management manner as well as business strategy to reach their goal rather than depending on share repurchase action because after share repurchase, firm's leader may change, and if share repurchase is conducted regularly, outsiders may also understand discover some problem of firms, which may result to negative effect of share repurchases as well as ROA, ROE and profit margin of the firm.

### Reference

- [1] Ahn, H.-J., Cao, C., & Choe, H. (2001). Share repurchase tender offers and bid-ask spreads. *Journal of Banking & Finance*, 25(3), 445-478.
- [2] Bagwell, L. S. (1991). Share Repurchase and Takeover Deterrence. *The RAND Journal of Economics*, 22(1), 72-88.
- [3] Bhargava, A. (2013). Executive compensation, share repurchases and investment expenditures: econometric evidence from US firms. *Review of Quantitative Finance and Accounting*, 40(3), 403-422.
- [4] Bierman, H. (2001). *Increasing share holder value-Distribution policy. a corporate finance challenge* (1 ed.). NY: Kluwer Academic Publishers.
- [5] Bozanic, Z. (2010). Managerial motivation and timing of open market share repurchases. *Review of Quantitative Finance and Accounting*, 34(4), 517-531.
- [6] Cheng, L.-Y., & Lin, Y.-E. (2012). Institutional investment horizons and open-market stock repurchases: evidence from the Taiwan stock market. *Applied Financial Economics*, 22(7-9), 611-623.
- [7] Dickinson, V., Kimmel, P., & Warfield, T. (2012). The accounting and market consequences of accelerated share repurchases. *Review of Accounting Studies*, 17(1), 41-71.
- [8] Evans, J. P., & Evans, R. T. (2001). Accounting Performance of Firms Pursuing a Share Repurchase Strategy. *Asian Review of Accounting*, 9(2), 56 - 74.
- [9] Gong, G., Louis, H., & Sun, A. X. (2008). Earnings management and firm performance following open-market repurchases. *The Journal of Finance*, LXIII(2), 847-986.
- [10] Grullon, G., & Ikenberry, D. L. (2000). What do we know about stock repurchase? (J. M. Stern, & D. H. Jr., Eds.) *Journal of Applied Corporate Finance*, 13(1), 31-51.
- [11] Grullon, G., & Ikenberry, D. L. (2003). *The revolution in corporate finance* (4 ed.). Chennai: Blackwell Publishing Ltd.
- [12] Grullon, G., & Michaely, R. (2004). The Information Content of Share Repurchase Programs. *The Journal of Finance*, 59(2), 651-680.
- [13] Hackethal, A., & Zdantchouk, A. (2006). Signaling Power of Open Market Share Repurchases in Germany. *Financial Markets and Portfolio Management*, 20(2), 123-151.
- [14] Hurtt, D. N., Kreuzer, J. G., & Langsam, S. A. (2008). Stock Buybacks and Their Association with Stock Options Exercised in the IT Industry. *American Journal of Business*, 23(1), 13 - 22.
- [15] Indro, D. C., & Larsen, G. A. (1996). Duration of share repurchase programs and firm performance. *Journal of*

- Economics and Finance, 20(1), 101-116.
- [16] Jonga, A. d., Dijkb, R. v., & Veld, C. (2003). The dividend and share repurchase policies of Canadian firms: empirical evidence based on an alternative research design. *International Review of Financial Analysis*, 12(4), 349–377.
- [17] Kim, H. J., Jo, H., & Yoon, S. S. (2013). Controlling shareholders' opportunistic use of share repurchases. *Review of Quantitative Finance and Accounting*, 41(2), 203-224.
- [18] Kim, J. (2007). Buyback trading of open market share repurchase firms and the return volatility decline. *International Journal of Managerial Finance*, 3(4), 316 - 337.
- [19] Leng, F., & Zhao, K. M. (2012). Insider trading around open-market share repurchases. *Journal of Economics and Finance*. doi:10.1007/s12197-012-9227-x
- [20] Liang, W.-l., Chan, K., Lai, W.-H., & Wang, Y. (2013). Motivation for Repurchases: A Life Cycle Explanation. *Journal of Financial Services Research*, 43(2), 221-242.
- [21] Lie, E. (2004). Operating performance following open market share. *Journal of Accounting and Economics*.
- [22] Lie, E. (2005). Operating performance following open market share repurchase announcements. *Journal of Accounting and Economics*, 39(3), 411–436.
- [23] Lie, E. (2005). Operating performance following open market share repurchase announcements. *Journal of Accounting and Economics*, 39, 411–436.
- [24] Lin, Y.-M., Liu, Y.-Y., You, S.-J., & Shiu, J.-Y. (2012). Board composition, corporate ownership and market performance: evidence from Taiwan. *Applied Financial Economics*, 22(14), 1193-1206.
- [25] Michaluk, G. (2007). *The marketing director's role in business planning and corporate governance*. Chichester: John Wiley & Son Ltd.
- [26] Ritter, J. R. (2005). *Recent developments in corporate finance Volume II*. MA: An Elgar Collection.
- [27] Ross, S. A., Westerfield, R. W., & Jordan, B. D. (2000). *Fundamentals of Corporate Finance* (5 ed.). NY: Irwin McGraw-Hill.
- [28] Ross, S. A., Westerfield, R. W., & Jordan, B. D. (2008). *Essentials of corporate finance* (6 ed.). NY: MCGraw-Hill/Irwin.
- [29] Sinha, S. (1991). Share Repurchase as a Takeover Defense. *Journal of Financial and Quantitative Analysis*, 26(2), 233-244.
- [30] Weigand, R. A., & Baker, H. K. (2009). Changing perspectives on distribution policy: The evolution from dividends to share repurchase. *Managerial Finance*, 35(6), 479 - 492.
- [31] Wilber, R. S. (2007). Why do firms repurchase stock to acquire another firm? *Review of Quantitative Finance and Accounting*, 29(2), 155-172.
- [32] Zhang, H. (2005). Share price performance following actual share repurchases. *Journal of Banking & Finance*, 29(7), 1887–1901.



# Factors Affecting to The Success of The Contemporary Management Accounting Practices in Vietnamese Enterprises

Do Huyen Trang and Le Mong Huyen\*

Department of Economic & Accounting, Quy Nhon University, Binh Dinh province, Postcode 820000, Viet Nam

## ABSTRACT

Management accounting is increasingly becoming an important tool to support the managers in managing the business operations of the enterprises. When entering the industrial revolution 4.0, Vietnamese businesses need to explore and use the contemporary management accounting practices to provide accurate, complete and timely information to make right business decisions. Identifying the factors that affect to the success of the contemporary management accounting practices is essential for Vietnamese businesses in order to have solutions to improving their accounting information systems. The findings show that managers/owners and internal characteristics of firms have positive influences on the success of the contemporary management accounting practices. From the results of this research, we proposed some solutions for improving the ability to successfully adopt the contemporary management accounting practices of Vietnamese enterprises.

**Keywords:** Management accounting, contemporary management accounting, Vietnamese enterprises, diffusion of innovation theory

## 1. Introduction

The industrial revolution 4.0 is a digital boom with three core elements: artificial intelligence, internet on things and big data. Therefore, every economy and every country must try to change thoroughly. Businesses are not out of the general trend. The function of management accounting is to provide internal management information for enterprises, so that each enterprise equips itself with a complete information system towards a big data management system for the entire economy in the industrial revolution 4.0, which requires enterprises to constantly innovate and apply new tools including contemporary management accounting.

In the 6th edition of management accounting book, Atkinson et al. (2012, pp.2) wrote: "Management accounting is the process of supplying the managers and employees in an organization with relevant information, both financial and nonfinancial, for making decisions, allocating resources, and monitoring, evaluating, and rewarding *performance*".

Contemporary management accounting is considered the intersection between strategic management and accounting, therefore it is also called strategic management accounting. Strategic management accounting was first mentioned by Simmonds (1981), whereby strategic management accounting is the usage and analysis of management accounting information of a business and its competitors to develop and control a business's strategy. Then, some have studied and discussed about strategic management accounting, but there is no widely-accepted formal concept (Doan, 2012; Do and Le, 2016). Contemporary management accounting practices are often used such as target costing, the balanced scorecard (BSC), activity based costing (ABC), evaluate competitors based on public reporting, customer profitability analysis and so on.

If traditional management accounting directs to internal administer, contemporary management accounting directs to external and the future, uses both financial and non-financial information to make decisions. So, contemporary management accounting not only provides information about the enterprise but also provides information about customers, competitors, markets and the external environment, which allows enterprises proactively create and enhance competitive advantage to achieve the best business performance.

\* Corresponding author. Tel.: +8401685746693  
E-mail address: lemonghuyendhq@gmail.com

A number of studies have been performed and demonstrated that the application management accounting in enterprises is influenced by many internal and external factors. These impacts may limit or increase the feasibility and effectiveness of applying management accounting in the enterprises. However, nowadays, on over the world as well as in Vietnam, there are still few studies investigating the factors that influence the success of contemporary management accounting practices. Moreover, most of the studies about the factors that influence the usage of management accounting have been conducted on the basis of the contingency theory and institutional theory. In this study, we based on diffusion of innovation theory of Rogers (1983) to explain the factors affecting the success of contemporary management accounting practices in Vietnamese firms.

## **2. Theoretical framework and literature review**

### **2.1. Diffusion of innovation theory**

Diffusion of innovation is a classic work of propagation of new ideas by Rogers (1983). According to him, diffusion is the process by which an innovation is communicated through certain channels over the time among the members of a social system. Rogers (1983) found that the decision of an individual to accept an innovation was not an immediate action. Instead, it is a multi-stage process that affects their readiness to adopt an innovation. The process consists of the following five steps: (1) Knowledge – person becomes aware of an innovation and has some idea of how it functions; (2) Persuasion – person forms a favorable or unfavorable attitude toward the innovation; (3) Decision – person engages in activities that lead to a choice to adopt or reject the innovation; (4) Implementation – person puts an innovation into use; (5) Confirmation – person evaluates the results of an innovation decision already made.

In addition, Rogers (1983) also analyzes the factors influencing the acceptance process of innovation in the organization. According to him, there are three main factors: (1) Individual leader characteristics: As a leader, managers have a significant influence on accepting innovation through advocacy, direction, guidance, and implementation; (2) Internal characteristics of organization: Organizational size, decentralization, staffing levels, departmental and staff relationships are important factors in the adoption or rejection of innovation in the organization; (3) External characteristics of organization: The competitive environment, uncertainty of the environment or customer pressure will open up opportunities for innovation in the organization.

The "new" can be an idea, a tool or a technique that is supposed to be new with the organization (Rogers, 1983). The contemporary management accounting practices is considered "new" in Vietnamese enterprises. Thus, in this study, we based on the diffusion of innovation theory to explain the factors affecting to the contemporary management accounting practices.

### **2.2. Literature review**

In the world, since the 1980s, Otley has studied the influence of contingency variables on the management accounting practices. Initially, contextual factors referred to the external environment, technology, organizational structure, and organizational size (Waterhouse & Tiessen, 1978; Otley, 1980). In the last two decades of the 20th century, accounting researchers added culture (O'Conner, 1995) and strategies (Langfield-Smith, 2006). Following this line of study, Haldma and Laats (2002) concluded that contingency factors influenced the usage of management accounting in large companies in Estonia. In addition, the legal accounting environment and the quality of the accountant are also appeared to affect the usage of management accounting. In a study in South Africa, Waweru et al. (2004) concluded that internal and external factors influenced the management accounting change. Meanwhile, the increase in competition, the development of science and technology and the external pressures are factors that promote the change of management accounting. In contrast, lack of financial resources and psychological fear of innovation or "no need to change" attitude hindered the change of management accounting. The results of Abdel-Kader and Luther (2008) show that the factors influencing the management accounting practices in UK food and beverage companies include: Environmental uncertainty, decentralization, scale, advanced techniques management (ATM), total quality management (TQM), Just-in-Time (JIT), and customer resources.

In Vietnam, the study of the factors affecting to the management accounting practices has only been addressed in the last few years. The most prominent amongst these is Doan's study (2012) which identified the factors that affect to strategic management accounting practices. Research results indicate that competition and decentralization show direct influence on the strategic management accounting practices. In addition, the results of the study also show that strategic management accounting practices give direct influence on enterprises performance. Next, Tran's doctoral thesis (2016) identified eight factors that influence on the use of management accounting in SMEs such as: (1) decentralization, (2) organizational cost of management accounting, (3) organizational culture; (4) strategy, (5) state ownership level, (6) competition level, (7) awareness of management accounting of managers/owners. Nguyen (2016) showed that limited awareness, lack of resources, limited psychological change, limited strategic and business goals, lack of leadership support, limited technical application and limited organizational structure have hindered the use of ABC in Vietnamese enterprises. In study of factors affecting the use and consequences of management accounting practices in a transitional

economy: the case of Vietnam, Doan (2016) identified that both decentralization and competition have a positive, significant influence on the use of new management accounting practices except for the old ones. In addition, research also revealed that the use of management accounting practices has a positive influence on enterprise performance.

Up to now, there has been little research on the relationship between the level of the management accounting practices and the success of the management accounting practices. Some studies have been conducted to examine the relationship between the usage of the management accounting and organizational performance. For example, Phan et al. (2014) showed that the level of use ABC / ABM influenced the success of using this technique. In a study of strategic management accounting, Doan (2012) concluded that the usage of strategic management accounting had a positive impact on organizational performance. In addition, some studies on accounting information systems have demonstrated the relationship between the adoption of information systems and the success of information systems through the benefits of adopting this system (Tuomela, 2005).

### 3. Research model and methods

#### 3.1. Research model

The managers/owners have a significant influence on the acceptance innovation in the organization in general (Rogers, 1983) and the adoption of the contemporary management accounting practices in particular. Because managers/owners have an important role in making idea, planning and implementing management accounting practices. Nguyen's (2016) study showed that the lack of leadership support will negatively affect the successful usage of activity based costing method in Vietnamese enterprises. Tran (2016) argued that awareness of managers/owners about management accounting has significant influence on the management accounting practices in small and medium enterprises in Vietnam. Previously, the study by Al-Mamary et al. (2014) showed that the support of senior managers is one of the factors that influence the successful accounting information systems application in organizations in order to improve organizational performance. Thus, the first hypothesis is:

Hypothesis 1: There is a relationship between managers/owners with the level of the contemporary management accounting practices.

Rogers (1983) argued that internal characteristics of the enterprise such as organizational size, decentralization, staffing levels, departmental and staff relationships are important factors in the adoption or rejection of innovation in the organization. The internal factors of the enterprise are mentioned by many researchers at home and abroad such as: Haldma and Laats (2002) showed that the complexity of cost accounting and budgeting will increase with the size of the organization. Chenhall and Morris (1986), Abdel-Kader and Luther (2008), Doan (2012, 2016), Tran (2016) showed that decentralization has a significant influence on the management accounting practices. Chenhall and Langfield-Smith (1998) concluded that the usage of management accounting tools are beneficial for both strategies (consists of cost leadership and innovative differentiation). In order to successful managerial accounting practices in the organization, Tran (2016) argued that accountant's qualifications can not be ignored. Thus, the second hypothesis is:

Hypothesis 2: There is a relationship between the internal characteristics of the enterprise and the level of the contemporary management accounting practices.

Management accounting researchers based on contingency theory assumed that the external environment is one of the factors that influence on management accounting practices (Otley, 1980; Chenhall and Morris, 1986; Chenhall, 2007). Rogers (1983) also acknowledged that the external environment influences the acceptance of innovation in organization. Mia and Clarke (1999) argue that the higher competitive level, the more businesses use management accounting information systems. Waweru et al. (2004) showed that not only internal organizational factors, but also external environment significant influences on the usage of management accounting. The same opinion, authors such as Doan (2012, 2016) and Tran (2016) indicated that competitive level has positive influence on the usage of management accounting in Vietnamese enterprises. Thus, the third hypothesis is:

Hypothesis 3: There is a relationship between the external environment of the enterprise and the level of the contemporary management accounting practices.

When studying the factors affecting usage of management accounting, Doan (2012, 2016) concludes that usage of management accounting has a positive influence on the organizational performance. The research results of Phan et al. (2014) showed that the level of use ABC/ABM influenced the success of using this tool. Tuomela (2005) demonstrated the relationship between the adoption of information systems and the success of information systems through the benefits of adopting this system. Thus, the fourth hypothesis is:

Hypothesis 4: There is a relationship between the level of the contemporary management accounting practices and the success of the contemporary management accounting practices.

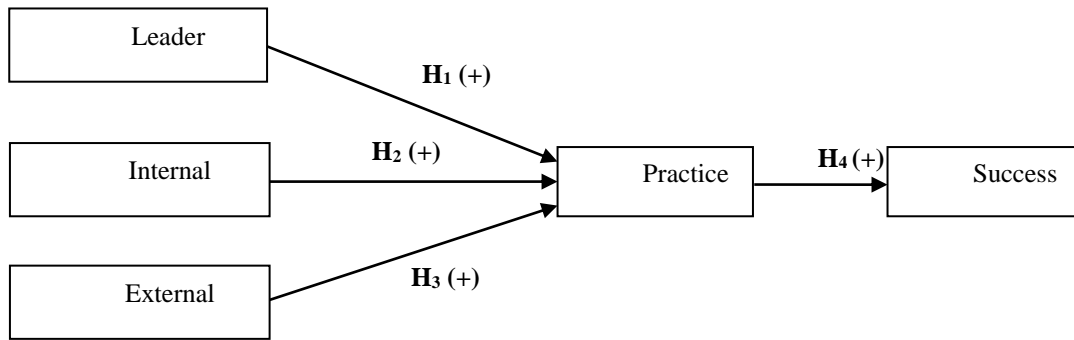

**Figure 1: Factors affecting to the success of the contemporary management accounting practices**

(Source: We have synthesized)

Variable measurement in this research is based on the previous researches and diffusion of innovation theory. Firstly, the measurement for managers/owners developed from Rogers's (1983) theory. According to him, managers/owners are measured through three observation variables: attitudes towards change, awareness of contemporary management accounting, and support or participation of leaders in the implementation and the usage of contemporary management accounting in organization. Secondly, we are based on the view of diffusion of innovation theory (Rogers, 1983) and contingency theory that used commonly in management accounting studies (Chenhall, 2007) to propose measures for the internal characteristics of the enterprise and external environment. Accordingly, the internal characteristics of the enterprise are measured through four observation variables: organizational size, organizational structure, strategy, and qualifications of accountant (see Otley, 1980; Rogers, 1983; Chenhall and Morris, 1986; Chenhall, 2007). The external environment is measured by three observable variables: uncertainty, competition and pressure from customers (see Rogers, 1983; Chenhall, 2007). Next, a scale developed by Chenhall and Langfield-Smith (1998) and was adapted to assess the extent of adoption of contemporary management accounting practices in Vietnamese companies. After discussing with experts who are knowledgeable about contemporary accounting management, we divide the tools into three groups: costing and budgeting, performance evaluation and decision support. With the above measures, participants were asked to respond to each item on a five-point Likert scale ranging from 1 (very few) to 5 (very high). Finally, the success of the three contemporary management accounting practices groups, which were adapted from Chenhall and Langfield-Smith (1998), was assessed by asking the respondents to indicate the rate of success of each practice in their business unit on a five-point Likert scale ranging from 1 (very unsuccessful) to 5 (very successful).

### 3.2. Research methods

This research is conducted through two phases: preliminary research and formal research.

First, preliminary research is conducted through qualitative research and quantitative research. (1) Qualitative research was conducted by discussing with 8 experts about the factors affect the success of the contemporary management accounting practices in Vietnamese enterprises. Then, we built the research model and drafted the draft scale. (2) In the next step, the quantitative pilot study was conducted by a 30-sample survey to detect errors and check the scale. The results of this phase will help us to develop a full scale survey for formal research.

Next, the formal study was conducted by quantitative research. After a complete survey, we interviewed, telephoned or emailed the survey respondents (CFO, Chief Accountant, General Accountant and some accountants who knowledge of MA and working in Vietnamese enterprises in Binh Dinh province and Ho Chi Minh City). The result was 234 responses, of which 177 valid questionnaires were used for data entry. After encrypting and cleaning the data, we performed the analysis on SPSS 20 and AMOS 22 software as follows: Cronbach's Alpha, Exploratory Factor Analysis (EFA), Confirmatory Factor Analysis (CFA), and Structural Equation Modeling (SEM).

## 4. Research results

### 4.1. Cronbach's Alpha

Cronbach's Alpha of SPSS 20 is used to test the reliability of the scale components. Results show that all scales meet the reliability requirement (Cronbach's alpha > 0.6). The corrected item-total correlations of the scales are higher than the permissible range (> 0.3) so that all scales are included in the Exploratory Factor Analysis in the next step.

**Table 1: Cronbach's Alpha**

Composition	N of Items	Cronbach's Alpha	Corrected Item – Total Correlation min
Leader	5	0.794	0.467
Internal	4	0.811	0.537
External	4	0.730	0.456
Practice	3	0.667	0.428
Success	3	0.811	0.630

(Source: Excerpt from the results of SPSS 20)

**4.2. Exploratory Factor Analysis (EFA)**

The results of Exploratory Factor Analysis with Promax rotation on SPSS 20 extracted two independent factors from the first 13 observed variables (see Table 2). The analysis showed that the external environment is not significant and was excluded from the research model.

The Kaiser-Meyer-Olkin (KMO) is 0.807 ( $> 0.5$ ) with the significance level of the Bartlett's Testis 0.000 ( $< 0.05$ ), indicating that the exploratory factor analysis of the independent components is appropriate. The cumulative variance of 66.822% indicates that the three factors explain 66.822% variation in data research, at the Eigenvalues of 1.258.

The Kaiser-Meyer-Olkin of practice and success are 0.629 and 0.711, with the significance level of Bartlett's Testis 0.000 ( $< 0.05$ ), indicating that the exploratory factor analysis of the dependent components is appropriate. The cumulative variance of practice and success are 60.243% and 72.851% which should explain the variability of the data.

**Table 2: Pattern Matrix<sup>a</sup>**

	Factor	
	1	2
internal4	.843	
internal1	.792	
internal3	.670	
internal2	.581	
leader5		.813
leader3		.748
leader1		.640

(Source: Excerpt from the results of SPSS 20)

**4.3. Confirmatory Factor Analysis (CFA)**

The Confirmatory Factor Analysis results with the support of AMOS 22 showed that indicators of suitability of the model were satisfactory, such as: Chi-square / df = 1.329 ( $< 2$ ); GFI = 0.973 ( $> 0.9$ ); TLI = 0.984 ( $> 0.9$ ); CFI = 0.990 ( $> 0.9$ ) and RMSEA = 0.043 ( $< 0.8$ ). This proves that the model is fit with the research data. Next, we test convergent validity, reliability and discriminant validity.

**Table 3: Regression Weights (Group number 1 - Default model)**

			Estimate	S.E.	C.R.	P	Label
internal4	<---	internal	1.000				
internal1	<---	internal	.868	.083	10.424	***	
internal3	<---	internal	.681	.081	8.377	***	
internal2	<---	internal	.566	.071	7.947	***	
leader5	<---	leader	1.000				
leader3	<---	leader	1.164	.132	8.823	***	
leader1	<---	leader	.781	.109	7.162	***	

(Source: Excerpt from the results of AMOS 22)

**Table 4: Standardized Regression Weights (Group number 1 - Default model)**

			Estimate
internal4	<---	internal	.806
internal1	<---	internal	.819
internal3	<---	internal	.648
internal2	<---	internal	.617
leader5	<---	leader	.768
leader3	<---	leader	.842
leader1	<---	leader	.590

(Source: Excerpt from the results of AMOS 22)

About of convergent validity, the regression weights are statistically significant ( $p$ -value  $< 0.05$ ) and all the Standardized Regression Weights are  $> 0.5$ . Therefore, we can conclude that observable variables are used to measure the factors of the model have convergent validity.

About reliability, the composite reliability and total average variance extracted are  $> 0.5$ . In addition, the Cronbach's Alpha of the factors are recalculated  $> 0.7$ . Therefore, it can be concluded that all scales in the model are reliable.

**Table 5: Reliability test**

Factor	Composite reliability	Average variance extracted	Cronbach's Alpha
leader	0.782	0.549	0.777
internal	0.816	0.530	0.811

(Source: We recalculated from the results of AMOS 22)

About discriminant validity, the correlation coefficient between the two components is 0.591 ( $< 0.9$ ) and the  $p$ -value is 0.000 ( $< 0.05$ ).

**4.4. Structural Equation Modeling (SEM)**

The Structural Equation Modeling results with the support of AMOS 22 show Chi-square /  $df = 1.392 (< 2)$ ; GFI = 0.933 ( $> 0.9$ ); TLI = 0.966 ( $> 0.9$ ); CFI = 0.974 ( $> 0.9$ ) and RMSEA = 0.047 ( $< 0.8$ ). This proves that the estimation model is consistent with the research data.

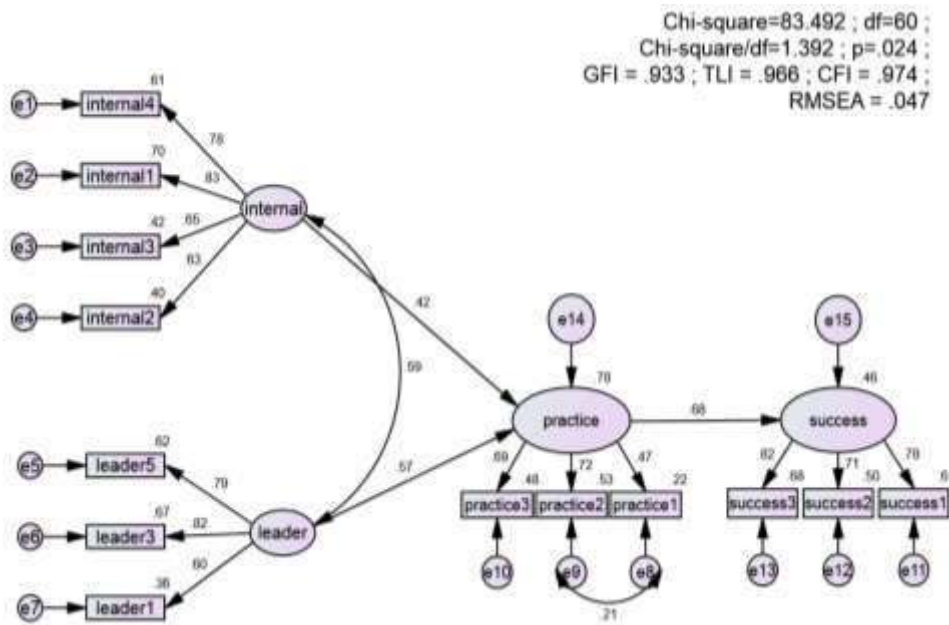

**Figure 2: Model of factors affecting to the success of the contemporary management accounting practices in Vietnamese enterprises**

(Source: Excerpt from the results of AMOS 22)

In addition, regression weights were statistically significant because of p-value < 0.05 (see Table 6). Therefore, it can be concluded that the characteristics of leaders and internal characteristics of enterprises actually affect the level of the contemporary management accounting practices; The level of the contemporary management accounting practices actually affect on the success of the contemporary management accounting practices.

**Table 6: Regression Weights (Group number 1 - Default model)**

			Estimate	S.E.	C.R.	P	Label
practice	<---	internal	.237	.066	3.604	***	
practice	<---	leader	.347	.081	4.275	***	
success	<---	practice	1.091	.223	4.896	***	
internal4	<---	internal	1.000				
internal1	<---	internal	.912	.086	10.625	***	
internal3	<---	internal	.699	.084	8.297	***	
internal2	<---	internal	.596	.074	8.088	***	
leader5	<---	leader	1.000				
leader3	<---	leader	1.105	.112	9.910	***	
leader1	<---	leader	.779	.103	7.546	***	
practice1	<---	practice	1.000				
practice2	<---	practice	1.482	.242	6.116	***	
practice3	<---	practice	1.235	.230	5.380	***	
success1	<---	success	1.000				
success2	<---	success	1.002	.113	8.848	***	
success3	<---	success	1.067	.108	9.844	***	

(Source: Excerpt from the results of AMOS 22)

**Table 7: Standardized Regression Weights (Group number 1 - Default model)**

			Estimate
practice	<---	internal	.417
practice	<---	leader	.574
success	<---	practice	.680
internal4	<---	internal	.782
internal1	<---	internal	.835
internal3	<---	internal	.645
internal2	<---	internal	.630
leader5	<---	leader	.786
leader3	<---	leader	.818
leader1	<---	leader	.602
practice1	<---	practice	.468
practice2	<---	practice	.725
practice3	<---	practice	.690
success1	<---	success	.781
success2	<---	success	.706
success3	<---	success	.822

(Source: Excerpt from the results of AMOS 22)

Looking at the results of standardized regression weights, it can be seen that the managers/owners and internal characteristics of organization impact positively on the level of the contemporary management accounting practices in Vietnamese enterprises. In particular, the managers/owners have a stronger influence on the internal characteristics enterprise because of a higher estimate of  $\beta$  ( $0.574 > 0.417$ ). In addition, the results also show that on the level of the contemporary management accounting practices has a significant effect ( $\beta = 0.68$ ) on the success of the contemporary management accounting practices in Vietnamese enterprises.

## 5. Discussions and conclusions

First of all, when using Confirmatory Factor Analysis, the external environmental factors didn't achieve convergent validity, reliability and discriminant validity. Therefore, we decided to remove this factor from the research model. This result does not agree with previous researches. However, when we talked with experts about this research results, we received the consent. They think that this result is consistent with conditions in Vietnam because before they make decision to adopt a contemporary management accounting practice, they will consider the internal factors of the business such as financial and human resources (the level of the accountant). Although businesses are facing high competitive pressure when there is no financial support and there is a limited level of accounting staff, then businesses won't accept contemporary management accounting practices.

Secondly, our research results show that the managers/owners has a positive influence on the level of management accounting practices. Previously, Tran's study (2016) also concluded that the perception of the manager is an important factor that affects the usage of management accounting in business. Research results of Nguyen (2016) also agree with our study that the psychological limitation of change and the lack of support from leaders are factors that prevent the successful usage of activity based costs method (ABC) in Vietnamese enterprises. With the role of administrators, the managers/owners have the right to make decisions regarding to the organization and application of management accounting, add or improve the new management accounting techniques in the business. Therefore, in the coming time to improve the level of using contemporary management accounting practices, it is necessary to raise awareness of the managers/owners about the roles and benefits of contemporary management accounting techniques for businesses. In our opinion, this responsibility belongs to professional associations and educational organization.

Thirdly, the internal characteristics enterprise such as the size, structure, strategy and qualifications of accountant can also significantly affect the level of contemporary management accounting practices. The research results agree the views with management accounting researchers based on the contingency theory (Otley, 1980; Chapman, 1997; Chenhall, 2007). Abdel-Kader and Luther (2008) also pointed out that the large and decentralized organizations used techniques of management accounting more complex than small and concentrated organizations. Because large organizations often have large financial resources and better human resource to adjust, up-grade or replace current management accounting system (Rogers, 1983). To be successful, the contemporary management accounting practices in business needs to consider qualifications of accountant (Tran, 2016).

Finally, the research results show strong positive relationship between the level of contemporary management accounting practices and the success of the contemporary management accounting practices in the Vietnamese enterprises. Our conclusions about the hypothesis 4 along with the point of previous researchs such as Tuomela (2005), Doan (2012) and Phan et al. (2014). The result of this research helps to explain the fact that the limited level of using the techniques of contemporary management accounting in Vietnamese enterprises, so the usage of this techniques does not gives the high success or benefit. Thus, in the context of the industrial revolution 4.0, to enhance competitive advantage and integration with the world economy, the Vietnamese enterprises need to know to choose the best most suitable contemporary management accounting technique to use in order to provide useful information for leader in making decisions promptly and correctly.

Any studies will exist some limitations and our study has no exception. In this study, our research sample is quite small (n = 177) and sampling by convenience methods so that it cannot bring high representative for population. In addition, in the research we have not tested the relationship directly between leaders/ owners and the internal characteristics enterprise and the success of the tool contemporary management accounting practices. This could be an interesting research direction for researchers in the future.

## References

- [1] Abdel-Kader, M., and Luther, R., (2008). The Impact of Firm Characteristics on Management Accounting Practices: A UK-Based Empirical Analysis. *The British Accounting Review*. 40(1), pp.2-27.
- [2] Al-Mamary, Y.H., et al. (2014). Factors affecting successful adoption of management information systems in organizations towards enhancing organizational performance. *American Journal of Systems and Software*, Vol.2, No.5, pp.121-126.
- [3] Atkinson, A., et al., (2012). *Management accounting: information for decision-making and strategy executive* (6th edition), New Jersey: Pearson Prentice Hall.
- [4] Chapman, C.S., (1997). Reflections on a contingent view of accounting. *Accounting, Organizations and Society*. Vol.22 (2), pp.189-205.
- [5] Chenhall, R.H., 2007. Theorizing Contingencies in Management Control Systems Research. In: Chapman, C.S., et



- al., eds. 2007. Handbook of Management Accounting Research. Oxford: Elsevier. Ch.6.
- [6] Chenhall, R.H., and Langfield-Smith, K. (1998). Adoption and benefits of management accounting practices: an Australian study. *Management Accounting Research*, Vol.9(1), pp.1-19.
- [7] Chenhall, R.H., and Morris, D. (1986). The impact of structure, environment, and interdependence on the perceived usefulness of management accounting systems. *The Accounting Review*, Vol.111(1), pp.16-35.
- [8] Do, T.H.T and Le, T.B., (2016). Fill the gaps in the concept and development of strategic management accounting. *Journal of Finance*, Vol.2(5), pp. 31-33.
- [9] Doan, N.P.A, (2012). Factors affecting on the use of strategic management accounting in Vietnamese enterprises. *Journal of Accounting Development in Vietnam*, No.264, pp.9-15.
- [10] Doan, N.P.A., (2016). Factors affecting the use and consequences of management accounting practices in a transitional economy: The case of Vietnam. *Journal of Economics and Development*, Vol.18, No.1, pp.54-73.
- [11] Haldma, T., and Laats, K., (2002). Contingencies influencing the management accounting practices of Estonian manufacturing companies. *Management Accounting Research*, Vol.13, pp.379–400.
- [12] Langfield-Smith, K., 2006. A review of quantitative research in management control systems and strategy. In: Chapman, C.S., et al., eds. 2007. Handbook of Management Accounting Research. Oxford: Elsevier. Ch.12.
- [13] Mia, L., and Clarke, B., (1999). Market competition, management accounting systems and business unit performance. *Management Accounting Research*, Vol.10, pp.137-158.
- [14] Nguyen, V.H., (2016). Factors hinder the use of ABC method in Vietnamese enterprises. Doctoral thesis. University of Economics Ho Chi Minh City.
- [15] O’connor, N.G., (1995). The influence of organizational culture on the usefulness of budget participation by singaporean-chinese managers. *Accounting, Organizations and Society*. Vol. 20(5), pp.383-403.
- [16] Otley, D.T., (1980). The contingency theory of management accounting: achievement and prognosis. *Accounting, Organizations and Society*. Vol.5, pp.413- 428.
- [17] Phan, T.N., Baird, K. and Blair, B., (2014). The use and success of activity-based management practices at different organisational life cycle stages. *International Journal of Production Research*. Vol.52(3), pp.787-803.
- [18] Rogers, E.M., (1983). Diffusion of innovations. Third Edition. London:The Free Press.
- [19] Simmonds, K., (1981). Strategic Management accounting. *Management Accounting*. Vol.59, pp.26–29.
- [20] Tran, N.H., (2016). Factors influencing the use of management accounting in SMEs in Vietnam. Doctoral thesis. University of Economics Ho Chi Minh City.
- [21] Tuomela, T.S., (2005). The interplay of different levers of control: a case study of introducing a new performance measurement system. *Management Accounting Research*. Vol.16(3), pp.293-320.
- [22] Waterhouse, J., and P. Tiessen., (1978). A contingency framework for management accounting systems research. *Accounting, Organizations and Society*. Vol.3(1), pp.65-76.
- [23] Waweru, N., et al., (2004). Management accounting change in South Africa: case studies from retail services. *Accounting, Auditing and Accountability Journal*. Vol. 17(5), pp.675–704.

International Conference For Young Researchers In Economics And Business, ICYREB 2017, October 30<sup>th</sup> 2017  
Da Nang, Vietnam

## Family Business Enterprises in International Trade – The Family Involvement and The Internationalization of The Companies

Nguyen Thi Thu Ha (MS.c)\*

Lecturer at UEH, Ho Chi Minh City, Vietnam

### ABSTRACT

The research aims to realize the influences of family involvement on firm performances in international business. Family involvement is percentage of family ownership to total company capital if family members hold CEO position or other top position in the company. International business performance is calculated by two criteria: revenue in international markets and number of physical international countries in which companies invest directly or number of subsidiaries. The result shows that the degree of family involvement affect negatively on international diversification of the firm while firm age support a better performance of this strategy. Firm size, on the other hand, has no relation to the firm internationalization.

**Keywords:** family business enterprises, family involvement, international trade performance, international business

### 1. Introduction

Family companies are popular firm's type around the business world despite the fact that the definition of this type of firm is different depending on which countries or industries that the companies belong to (Faccio & Lang, 2002). In recent days, there is a wide range of articles discussing the differences between family firms and non-family firms as well as impacts of this special type of firm to the economies as a whole (Gianpaolo et al., 2015). Some factors of family-owned firms are often conducted including the degree of family control, emotional involvement and family culture to represent some different results (Le Breton-Miller & Miller, 2013; Gómez-Mejía et al., 2011)

As a natural flow of development, family-owned enterprises would probably go abroad and this tendency has catch attention of many scholars these days because of effects of family-owned enterprises' natures to internationalization decision (Berrone et al., 2010; Gianpaolo et al., 2015; Graves & Thomas, 2008; Gómez-Mejía et al., 2011). However, these research findings are still not well understood and need deeper and wider discussion among researchers (Gianpaolo et al., 2015).

In Vietnam, family-owned companies play a vital role in developing the national economy and contribute to almost ¼ of the total GDP each year based on the annual report of the Vietnam Entrepreneur and Family Council (VCCI, 2013). There is a wide variety of sectors and industries that Vietnamese family enterprises belong to, from banking and finance to commerce, from heavy industries to high-quality services. These companies also differ from years of establishment and size, from start-up enterprises to long-lasting organization, from small and medium enterprises (SMEs) to large groups or even multinational corporations.

Recently, the internationalization of family-owned firms are becoming more popular and beginning getting some early successes. While there is general agreement that the idiosyncratic nature of family-owned enterprises influences internationalization performance of the companies, there are some major differences between family and non-family firms that effect to the decision of internationalization as well as the degree of this strategy's success among these firms. These differences, however, are still not conducted widely and thus need a lot more attention from researchers and economists.

In this article, Vietnamese family-owned enterprises' factors are conducted to test their impacts to the degree of firm's international diversification performance. To be more specific, family involvement to the firm is examined

\* Nguyen Thi Thu Ha. Tel.: +84938020226  
E-mail address: thuha@ueh.edu.vn

whether it affects internationalization's strategy. Time span that company involves in business is also matter in this research. Last but not least, size of company is included in the model test for evaluating its influences to firm's performance in expanding globally.

## 2. Literature Review

Capar & Kotabe (2003) referred internationalization as a firm's expansion outside the borders of its home country across different countries and regions. According to Hitt et al. (2007), international business is a strategy through which a firm expands the sales of its goods or services across the borders of global regions and countries into different geographic locations or markets. In previous studies, all terms such as internationalization, geographic diversification, international expansion, globalization, and multinationality are defined as the same strategic management constructs and this article also applies this definition as well.

### 2.1. *Family involvement and firm's internationalization*

The definition of family enterprises may different from each other depends on which factors used to separate. One of the crucial factors defines a firm a family company is the role of family member in the firm. In the past, researchers have found that the ownership structure has important influences to both firm strategy and performance (Thomsen & Pedersen, 2000; George et al., 2005; Abdellatif et al., 2010). Fernandez & Nieto (2006) included that family ownership and management might affect the vision of the company, especially the vision to internationalize the firm. There are three firm reasons explaining why and how levels of family control reduce the propensity to engage in international business.

First and foremost, family firms tend to avoid risks in business activities in a comparison with non-family firms (Gómez-Mejía et al., 2007). Usually, family firms prefer keeping managerial position belong to family rather than separating between ownership and management to others outside the family. As a result, they tend to have smaller management teams than non-family firms, which impact negatively on internationalization (Graves & Thomas, 2006). Moreover, boards of managers at this type of firms are usually uncomfortable with international strategies that require special knowledge and skills, often from external managers (Van Den Berghe & Carchon, 2003). In sum, family enterprises with high level of family involvement are often major obstacles to expand internationally or enjoy international business (Graves & Thomas, 2008). Financial resources are certainly the second reason explaining why family-owned SMEs are reluctant to entering international market. Family companies naturally tend to use internal capital rather than debt and outside equity (Graves & Thomas, 2008; Sciascia et al., 2012). These problems are even more serious in higher level of family involvement companies because the possibilities of raising capital would depend heavily on the resources of the family (Gianpaolo et al., 2015). In addition, one common thing in family-owned companies is that managers, who are also belong to the family tend to invest most of their wealth in the firm and thus, have more worried about losing their investment. As the result, they have a tendency to avoid or delay strategic decision relating to internationalization (Cerrato & Piva, 2012; Gómez-Mejía et al., 2010). Last but not least, family-owned companies tend to avoid internationalization because of their long-term vision that is their owned companies would be preserved for their future generation (Berrone et al., 2010). Family – owned companies therefore prefer enjoying less commitment of resources and less risk expanding strategies to internationalization (Gianpaolo et al., 2015). Taken together with three most important reasons mentioned above, a research hypothesis for this article is:

**Hypothesis 1:** The degree of family involvement in the firm is negatively related to internationalization.

### 2.2. *Firm age and its internationalization*

In term of the relationship between firm age and its decision to go abroad, previous studies had different, or even contrasting conclusion (Simon & Houghton, 2003; De Massis et al., 2014). Some researchers found that young companies eager to learn new things and able to take risks even though they have little experience of doing business inside and outside the borders in a comparison with older organizations. On the other hand, some believed that older firms with high level of experience and richer capital may lead to an increase of efficiency while doing international business and thus more willing to expanding internationally.

Applying these contrasting research results to family – owned companies, the analysis may become more complicated as when firm age, their family which the firm belongs to also grow (Gianpaolo et al., 2015). One plausible postulate for the impact of firm age to the relationship between family involvement and firm internationalization is that when firm get older, the negative impact of family involvement to firm internationalization will be moderated. There are some reasons explaining for this hypothesis. First and foremost, based on Uppsala model (Johanson & Vahlne, 1977, 2009) and its explanation about international process, it is believed that family companies would initially approach well-known countries and expanding gradually to others after extending their learning and experiences about international business. And as a result, this type of firm would be more efficiency in doing international business when they get older. In addition, as mentioned above, preserving for the future generation is something but common feature

among family companies. Younger generations, who take charge the companies from founders may acquire more skills and knowledge for internationalization and thus are more willing to expand their business outside the border (Gianpaolo et al., 2015). And they may also take advantage of the development of technical and commercial experience, that were accumulated domestically, and they may target different international markets rapidly (Zucchella et al., 2007; Calabrò et al., 2015). To sum up, this article postulated a second hypothesis is that:

**Hypothesis 2:** Firm age is positively related to firm internationalization.

### 3. Research Methodology

#### 3.1. Sample

In order to test the hypotheses, Vietnamese family-owned firms are collected. List of this type of firm are filtered via the website of HOSE (Ho Chi Minh City Securities Trading Center) and HNX-Index (The Hanoi Stock Exchange). These websites include both financial and accounting data for most of publicly traded Vietnamese firms. Original website of each collected companies are also used to confirm whether it is a family-owned firm and also the relationship between family members with the structure of the board of directors of the company. Detailed financial reports of these companies are also used when data is missing. At the first time, there are 117 family-owned companies are collected, but 12 companies are deleted from the research sample because of missing data. There are then 105 companies with their financial reports are utilized for this article. To obtain the family ownership variable, the percentage of firm shares held by shareholders with the same name was tabulated for each firm. In order to take into consideration also members of the family that did not have the same name (in-laws or children, for example), additional analysis of the ownership group was undertaken using the Notes to the Financial Statements (or other official financial reports), the company's website and financial newspapers. In the cases where one or more shareholders turned out to be companies, a deeper consideration is used for assuring whether or not a family controlled the company. At the end of the day, companies have to qualify these criteria: (1) the company had been found and run as a family-owned company; (2) the company is defined as a family-owned company at its official website or other financial reports and (3) data available.

The decision to collect 5-year time frame from 2011 to 2016 was based on the rationale of having a long enough time to qualify the research's quality as well as to minimize the probability of missing data. This 5-year period would reflect the most current which today's firms operate and also represent a stable situation of firms. There is also a little empirical diversification research about this period. In addition, a five-year period is desirable to achieve accurate evaluation and to avoid anomalies in the data.

#### 3.2. Independent Variables

This research applies the family involvement measurement of Gianpaolo et al. (2015), in which family involvement variable expressed both family ownership and managerial control. This variable would be coded as equal to the percentage of family ownership for the companies if at least one family relative hold CEO or president position of the company. On the other hand, if neither the CEO nor the president belonged to the family, family involvement would equal 0, making the variable left-censored (Gianpaolo et al., 2015; Chrisman & Patel, 2012; Patel & Chrisman, 2014). In addition, firm age is another variable applied in this research to measure family involvement to internationalization of the companies. This variable would be measured by the logarithm of the number of years that the firm had been in business (Gianpaolo et al., 2015).

#### 3.3. Dependent Variable

Internationalization's performance

For the measure of the degree of international business, scholars used different indices. Scholars argued that measures of internationalization should mention the relative size and strategic importance of both local and foreign business units (Geringer et al., 1989; Grant, 1987).

A popular measure to compute the degree of international business of firms is the ratio of foreign sales to total sale (FSTS) (Chang & Wang, 2007; Delios & Beamish, 2001; Geringer et al., 1989; Lu & Beamish, 2004; Tallman & Li, 1996). Other scholars also proposed a multidimensional measure including five items for this independent variable (Hitt et al., 1997; Gomes & Ramaswamy, 1999). Contractor et al (2007) argued that in any internationalization cases, FSTS is still an appropriate index of the degree of multinationality whether firms based on pure exports, exports and FDI activities or expanded through FDI only. They also showed that FSTS might measure more legitimate than others used in prior studies such as a number of foreign offices or number of international countries that firms operated. Jeong (2003) supported using the ratio FTST since he argued that measures of international business should reflect the relative size and strategic importance of foreign operations to the firms (Geringer et al., 2000). However, researchers also criticised that this measure might have serious limitations because of the content validity, criterion validity and reliability (Gomes & Ramaswamy, 1999). In addition, it was argued that since this index includes resale of intermediate goods,

they are not absolute measure of the degree of international business of firms. At the end of the day, this indicator seems to be a good relative measure and has been widely used (Geringer et al., 1989; Chang & Wang, 2007; Geringer et al., 2000).

Besides the FSTS measure, scholars also suggested using export intensity as a measure to calculate the degree of internationalization at early stage when firms mostly expand its business through exporting their products (Geringer et al., 2000). The authors also computed the ratio of sales by foreign business units to total international sales as another item to measure the level of international business. However, as the nature of internationalization strategy, export is just a very simple method for international business activities among firms, scholars showed that using export intensity as a measure of internationalization might be not appropriate for large MNEs or at the later stages of internationalization (Chang & Wang, 2007). Wiersema & Bowen (2008) also developed a formula to calculate the degree of internationalization of firms. This calculation, however, is argued not to be appropriate for studies about multinationality-performance relationship since it includes too many irrelevant variables such as trade barriers or industrial characteristics. Developing a new operationalized diversification measure, Qian et al. (2010) adopted both sales-based and subsidiary-based measures to examine the relationship between international business and the performance of MNEs. To be more specific, the authors included both sales and subsidiary diversification measures. This approach, however, seems similarly to prior studies when consisting sales performance and geographic scope that firms operate (Geringer et al., 2000; Hitt et al., 1997).

Another well-known approach is the asset dispersion entropy score developed in previous studies on international business (Goerzen & Beamish, 2003). This index was defined as:

$$ID = \sum E_c \times \ln(1/E_c)$$

where  $E_c$  is the number of employees in a particular country  $c$  and  $\ln(1/E_c)$  is the weight given to each country  $c$  or the natural logarithm of the inverse of the MNE's total employment (Hitt et al., 1997). However, this formula focuses mostly on the number of national markets that firms operate abroad as well as the potential effects of national markets to the performance of firms. In addition, this entropy mostly relates to the number of employees working for international business units. Therefore, this calculation is not appropriate for studies focus more about the interrelationship between multinationality and firm performance.

Similarly, Chang & Wang (2007) adopted a new entropy measure of international business, which is defined as

$$\sum [P_i \times \ln(1/P_i)]$$

where  $P_i$  is the percentage of sales at a given country  $i$  and  $\ln(1/P_i)$  is the weight of each geographic segment. Chang & Wang (2007) argued that this measure could include both the number of countries that firms operate and the level of contribution to total sales of each geographic segment and thus it is a more appropriate measure of the degree of internationalization (Hitt et al., 1997). Because of data availability constraints and also for comparison purposes, the FSTS ratio has been applied in this article.

### 3.4. Control Variable

Considering the important of firm size in expanding international strategies, this paper included company size, which may play a vital role in explaining the dynamics related to the dependent variable such as entry modes and the geographic location of international targets (Brush, 2012). Different size of firms could have potential different effect to the findings because of the amount of resources under managerial control (Chang & Wang, 2007). Firm size was calculated by the logarithm of the number of employees (Contractor et al., 2007).

### 3.5. Research Method

Dubofsky & Varadarajan (1987) found the value of reaffirming empirical results by repeating their previous studies. Hitt et al. (1997) also described the role of the replication studies which was considered as an integral part of the development of scientific methodologies. When investigating the relationship between family involvement and international diversification performance, previous studies adapted some different techniques (Capar & Kotabe, 2003; Contractor, 2007; Contractor et al., 2003; Delios & Beamish, 2001; Delios et al., 2008; Gianpaolo et al., 2015). Among them, the multiple regressions models are highly recommended because of its suitability to study the relationship among variables (Greene, 2010). Additionally, the methods are also suitable as both the independent variables and dependent variables are metric (Sharma, 1996). Therefore, this study will also adapt this method to investigate and analyze the relationship between these two variables.

## 4. Finding

### 4.1. Pearson correlation result

The Table 1 presents the mean, standard deviations and intercorrelations among the variables. According to Pindyck & Rubinfeld (1991), there are multicollinearity among variables if the correlations have absolute values greater

than 0.560. Based on that theory, there is no multicollinearity among variables.

**Table 1: Pearson correlation result**

Variables	Mean	s.d.	(1)	(2)	(3)	(4)
<b>1. ID Performance</b>	12.85	14.073	1			
<b>2. Family Involvement</b>	.10	.112	-.240	1		
<b>3. Company Size</b>	3.376	.438	.074	-.078	1	
<b>4. Company Age</b>	16.49	8.017	.222	.020	-.127	1

Source: author's calculation (These Pearson correlations are significant at the 0.05 level (two-tailed tests) at |0.02|.)

**Table 2: The multiple regression results**

Independent variables	Model 1	Model 2
<b>1. Family Involvement</b>	-.238* (-2.539)	-.245** (-2.619)
<b>2. Company Age</b>	.237* (2.518)	.227** (2.425)
<b>3. Company Size</b>	.086 (.909)	
<b>R squared</b>	.116	.109
<b>Adjusted R squared</b>	.090	.092
<b>F-value</b>	4.433**	6.246***

Source: author's calculation

Unstandardized regression coefficients are shown, with t-statistics in parentheses.

\* p < .05, \*\* p < .01, \*\*\* p < .001

This article conducts two different models. Model 1 has three independent variables including family involvement, company age and size, while company size is left in model 2 since its standardized coefficients value does not acquire the significant level. The results of R square, adjusted R square and F-value also point out that model 2 is the model fit (the best model) for examining suggested hypotheses.

#### 4.2. Discussion

The relationship between family involvement and ID performance is proven as negative because the standardized coefficients value of this variable ( $\beta < 0$ ) with significant higher than the 0.05 level. This finding is consistent with previous studies (Gianpaolo et al., 2015; Chrisman & Patel, 2012; Patel & Chrisman, 2014). Researchers almost agree with the idea that family enterprises with high level of family involvement are often major obstacles to expand internationally or enjoy international business (Graves & Thomas, 2008). Moreover, financial demanding is also another challenge that make family-owned firms feel hesitate to penetrate into other countries or doing business with foreign partners.

In regard to the relation between ID performance and firm age, this article supports the idea that older firms have tendency to go abroad than younger ones. It would be likely understood by mentioning the costs and experiences of internationalization. In addition, this type of firm may also take advantage of the development of technical and commercial experience, that were accumulated domestically, and they may target different international markets rapidly (Zucchella et al., 2007; Calabrò et al., 2015).

On the other hand, the size of the company is determined to have no influences on internationalization's performance of firms because the standardized coefficients value of this variable does not acquire the significant level. It means that family-owned enterprises does not need to acquire a certain degree of size (the number of employees) to expand internationally or company size does not matter but others does such as internationalization's experiences or involvement of family members to board of directors of the companies.

To sum up, this article supports the idea that degree of family involvement in the firm is negatively related to internationalization while older firms have tendency to expand internationally more efficiency than younger ones. Firms' size, on the other hand, does not matter to this internationalization.

#### 5. Implication and limitation

In this article, the relationship between family involvement and firm international diversification is conducted and resulted the negative relationship. To be more specific, family involvement impact negatively on firm performance in its internationalization. This result makes a contribution by pointing out the influence of family role to firm

performance in internationalization strategies. In addition, this article also confirms the positive affect of firm age to its performance in doing business internationally. This result may be explained that is because firms are likely having more experiences, enriching more customer relationship and acquiring more cultural learning, which result a better performance. The paper contributes to not only the family business literature but also the international business literature. However, this article has also some limitations that suggest the need for future research. First and foremost, future researches may conduct deeply in finding a different impact between family involvement and three-stage of internationalization of the firms (Contractor et al., 2007). Previous scholars had also determined that at different stages of internationalization, the relationship of this strategy with other factors is likely differently. Secondly, future research may compare this conducted relationship in different sectors, such as manufactures and services or in different industries, such as food industry and heavy industry. Last but not least, future researchers may also pay attention to different forms of internationalization that would be likely impacted differently by family involvement.

## References

- [1] Abdellatif, M., Amann, M. & Jaussaud, J., 2010. Family versus nonfamily business: a comparison of international strategies. *Journal of Family Business Strategy*, 2010, pp.108–116.
- [2] Berrone, P. et al., 2010. Socioemotional wealth and corporate responses to institutional pressures: do family-controlled firms pollute less?. *Administrative Science Quarterly*, 55, pp.82–113.
- [3] Brush, C., 2012. International entrepreneurship (RLE International Business): the effect of firm age on motives for internationalization..
- [4] Calabrò, A., Brogi, M. & Torchia, M., 2015. What does really matter in the internationalization of small and medium sized family businesses?. *Journal of Small Business Management*.
- [5] Capar, N. & Kotabe, M., 2003. The relationship between international diversification and performance in service firms. *Journal of International Business Studies*, 34, pp.345-55.
- [6] Cardona, M., Kretschmer, T. & Strobel, T., 2013. ICT and productivity: conclusions from the empirical literature. *Information Economics and Policy*, 25, pp.109–25.
- [7] Cerrato, D. & Piva, M., 2012. The internationalization of small and medium-sized enterprises: the effect of family management, human capital and foreign ownership. *Journal of Management Governance*, 16, pp.617–44.
- [8] Chang, S.-C. & Wang, C.-F., 2007. The effect of product diversification strategies on the relationship between international diversification and firm performance. *Journal of World Business*, 42, pp.61-79.
- [9] Chrisman, J.J. & Patel, P.C., 2012. Variations in R&D investments of family and nonfamily firms: behavioral agency and myopic loss aversion perspectives. *Academy of Management Journal*, 55 (4), pp.976–97.
- [10] Contractor, F.J., Kumar, V. & Kundu, S.K., 2007. *Journal of World Business*. Nature of the relationship between international expansion and performance: The case of emergin market firms, 42, pp.401-17.
- [11] Contractor, F.J., Kundu, S.K. & Hsu, C.C., 2003. A three-stage theory of international expansion: The link between multinationality and performance in service sector. *Journal of International Business Studies*, 34(1), pp.5-18.
- [12] De Massis, A., Chirico, F., Kotlar, J. & Naldi, L., 2014. The temporal evolution of proactiveness in family firms: the horizontal S-curve hypothesis. *Family Business Review*, 27(1), pp.37–50.
- [13] Dubofsky, P. & Varadarajan, P., 1987. Diversification and Measures of Performance: Additional Empirical Evidence. *Academy of Management Journal*, 30, pp.597-608.
- [14] Faccio, M. & Lang, L.H.P., 2002. The ultimate ownership of Western European corporations.. *Journal of Financial Economics*, 65, pp.365–95.
- [15] Fernandez, Z. & Nieto, M.J., 2006. Impact of ownership on the international involvement of SMEs. *Journal of International Business Studies*, 37, pp.340–51.
- [16] Gómez-Mejía, L.R., Cruz, C., Berrone, P. & De Castro, J., 2011. The bind that ties: socioemotional wealth preservation in family firms.. *Academy of Management Annals*, 5, pp.653–707.
- [17] Gómez-Mejía, L.R. et al., 2007. Socioemotional wealth and business risks in family- controlled firms: evidence from Spanish olive oil mills. *Administrative Science Quarterly*, 52(1), pp.106–37.
- [18] Gómez-Mejía, L.R., Makri, M. & Larraza-Kintana, M., 2010. Diversification decisions in family-controlled firms. *Journal of Management Studies*, 47(2), pp.223–52.
- [19] George, G., Wiklund, J. & Zahra, S.A., 2005. Ownership and the internationalization of small firms. *Journal of Management*, 31(2), pp.210–33.
- [20] Geringer, J.M., Tallman, S. & Olsen, D.M., 2000. Product and geographic diversification among Japanese multinational firms. *Strategic Management Journal*, 21, pp.51–80.
- [21] Gianpaolo, B., Bettinelli, C., Del Bosco, B. & Loane, S., 2015. The impact of family involvement on the investments of Italian small-medium enterprises in psychically distant countries. *International Business Review*.
- [22] Goerzen, A. & Beamish, P.W., 2003. Geographic Scope and Multinational Enterprise Performance. *Strategic Management Journal*, 24, pp.1289-306.
- [23] Gomes, L. & Ramaswamy, K., 1999. An empirical examination of the form of the relationship between

- multinationality and performance. *Journal of International Business Studies*, 30, pp.173-88.
- [24] Graves, C. & Thomas, J., 2006. Internationalization of Australian family businesses: a managerial capabilities perspective.. *Family Business Review*, 19(3), pp.207–24.
- [25] Graves, C. & Thomas, J., 2008. Determinants of the internationalization pathways of family firms: an examination of family influence. *Family Business Review*, 21(2), pp.151–67.
- [26] Greene, W.H., 2010. *Econometric Analysis*. Sixth Edition ed. New York: Pearson Education.
- [27] Hitt, M.A., Hoskisson, R.E. & Kim, H., 1997. International diversification: Effects on innovation and firm performance. *Academy of Management Journal*, 40, pp.767–98.
- [28] Hitt, M., Hoskisson, R. & Kim, H., 1997. International diversification: effects on innovation and firm performance in product-diversified firms. *Academy of Management Journal*, 40, pp.767-98.
- [29] Hitt, M.A., Ireland, R.D. & Hoskisson, R.E., 2007. *Strategic management: Competitiveness and globalization*. 7th ed. Mason.
- [30] Jeong, I., 2003. A cross-national study of the relationship between international diversification and new product performance. *International Marketing Review*, 20(4), p.353.
- [31] Johanson, J. & Vahlne, J.E., 1977. The internationalization process of the firm - A model of knowledge development and increasing foreign market commitment. *Journal of International Business Studies*, 8, pp.23-32.
- [32] Johanson, J. & Vahlne, J.E., 2009. The Uppsala internationalization process model revisited: From liability of foreignness to liability of outsider ship. *Journal of International Business Studies*, 40, pp.1411–31.
- [33] Le Breton-Miller, I. & Miller, D., 2013. Socioemotional wealth across the family firm lyfe cycle: a commentary on ‘Family Business Survival and the Role of Boards’. *Entrepreneurship Theory and Practice*. , pp.1391–97.
- [34] Lu, J.W. & Beamish, P.W., 2004. International diversification and firm performance: The S-curve hypothesis. *Academy of Management Journal*, 47(4), pp.598-609.
- [35] Patel, P.C. & Chrisman, J.J., 2014. Risk abatement as a strategy for R&D investments in family firms. *Strategic Management Journal*, 35(4), pp.617–27.
- [36] Pindyck, R. & Rubinfeld, D., 1991. *Economic models and economic forecasts*. New York: McGraw-Hill, Inc.
- [37] Qian, G., Khoury, T.A. & Peng, M.W., 2010. Research notes and commentaries: the performance implications of intra-and inter-regional geographic diversification. *Strategic Management Journal*, 31, pp.1018-30.
- [38] Sciascia, S., Mazzola, P., Astrachan, J. & Pieper, T., 2012. The role of family ownership in international entrepreneurship: exploring non linear effects.. *Small Business Economics*, 38(1), pp.15-31.
- [39] Sharma, S., 1996. *Applied multivariate techniques*. New York: John Wiley and Sons, Inc.
- [40] Simon, M. & Houghton, S.M., 2003. The relationship among biases, misperceptions: and the introduction of pioneering products: examining differences in venture decision contexts.. *Entrepreneurship Theory and Practice*, 27, pp.105–24.
- [41] Tallman, S. & Li, J., 1996. Effects of international diversity and product diversity on the performance of multinational firms. *Academy of Management Journal*, 39, pp.179-96.
- [42] Thomsen, S. & Pedersen, T., 2000. Ownership structure and economic performance in the largest European companies. *Strategic Management Journal*, 21, pp.689–705.
- [43] Van Den Berghe, L.A.A. & Carchon, S., 2003. Redefining the role and content of corporate governance from the perspective of business in society and corporate social responsibility. *Corporate governance and capital flows in a global economy* .
- [44] VCCI, 2013. Vietnam Business Forum. [Online] Available at: HYPERLINK "http://vccinews.com/news\_detail.asp?news\_id=29157" [http://vccinews.com/news\\_detail.asp?news\\_id=29157](http://vccinews.com/news_detail.asp?news_id=29157) .
- [45] Wiersema, M.F. & Bowen, H.P., 2008. Corporate Diversification: The Impact of Foreign Competition, Industry Globalization, and Product Diversification. *Strategic Management Journal*, 29(2), pp.115-32.
- [46] Zucchella, A., Palamara, G. & Denicolai, S., 2007. The drivers of the early internationalization of the firm. *Journal of World Business*, 42(3), pp.268–80.



International Conference For Young Researchers In Economics And Business, ICYREB 2017, October 30<sup>th</sup> 2017  
Da Nang, Vietnam

# Partial-Credit-Constraint and Complete-Credit-Constraint of Small and Medium Enterprises in Vietnam

Phan Dinh Khoi<sup>a,\*</sup> and Phan Ly Ngoc Thao<sup>b</sup>

<sup>a</sup>Chair of Department of Finance and Banking, College of Economics, Can Tho University, Vietnam

<sup>b</sup>College of Economics, Can Tho University, Vietnam

## ABSTRACT

Credit plays an important role in the development of enterprises, particularly small and medium-sized enterprises. Numerous policies to connect SMEs to formal credit institutions have been implemented; however, the number of SMEs that have not been able to borrow or have not fully obtained a formal loan still accounts for a high proportion. This research investigates factors influencing the level of formal credit constraint of SMEs in Vietnam based on using SMEs survey data by CIEM in 2015. The multinomial logistic regression model is used to estimate SMEs' credit constraints, the results show that SMEs partially and completely face credit constraints in the rationing process. Of which, years in operations, scales, status of business registration certificates, relationship with governmental institutions, membership of economic and social association, status of undue repayment, lenders of the enterprise, short-term maturity, new application status, and having a loan guarantor decrease the possibility of the formal credit constraints while age of owner/manager, being refusal of formal loans, having informal loans, and no collaterals increase the propability of formal credit constraints. In particular, the study also shows the differences of effect of factors between the cases of partial-credit-constraint and complete-credit-constraint

**Keywords:**Credit constraint; SMEs; Asymmetric Information; Vietnam

## 1. Introduction

Providing capital needs for small and medium enterprises (SMEs) through formal credit institutions has always been a paradox of a debate in economic development forums in recent years. In many developing countries, a large number of SMEs facing difficulties to obtain bank loans raises concerns of whether the credit markets are functioning well to forster the development of SMEs activities and growth. Although the credit markets are imperfect by nature due to asymmetric information (Stiglitz & Weiss, 1981; Hoff et al., 1993), standard lending practices including screening, monitoring and enforcement activities are strongly associated with credit rationing to any risky borrowers including SMEs (Fazzari et al., 1988; Bond and Meghir, 1994). However, the question whether or not SMEs face credit constraints in lending processes remains challenging to many empirical studies.

Literature on firm-level credit constraints in developed and developing countries provides insights on the consequences of credit constraints in a standard neoclassical investment model (Fazzari et al.1988; Bond and Meghir, 1994; Schiantarelli, 1996; Hubbard, 1998). Under a perfectly competitive credit market, any financial information of firms (including SMEs) should be orthogonal to investment decisions and therefore to the investment path. In particular, following Miller-Modigliani's theorem, firms should be indifferent between internal and external sources of funds, so any information related to the current liquidity of the firm should be irrelevant for investment. The standard test for credit constraints consists of adding over-identifying restrictions to an equation describing the investment path, such as an Euler equation or a flexible accelerator model. In most tests significant effects on the over-identifying restrictions have been found, hence, credit constraints matter for investment and firms face credit constraints.

In this paper, we specifically investigate whether SMEs in Vietnam face credit constraint by banks and formal financial institutions. In fact, SMEs is considered the largest group of enterprises in Vietnam, accounting for more than

\* Corresponding author. Tel.: +84 907552277.  
E-mail address: pdkhai@ctu.edu.vn

99% of the country's enterprises, contributing nearly 40% of GDP annually and creating about 50% of employment for the whole society (My Phuong, 2016). Although the State of Vietnam has issued many circulars and decrees to facilitate this group of enterprises to access more easily and use of funds from banks; however, according to the survey of the Science Institute for SMEs Management (SISME), up to 01/2016, only about 30% of SMEs have accessed to funds from official CIs.

Although research articles focussing on the issue of credit constraints in SMEs are vast, most studies focused solely on the issue of complete credit constraint but generally ignored the issue of partial credit constraint. Therefore, this study aims to overcome the above limitations by comprehensively looking at the issue of partial and complete credit constraints together. Following the introduction, section 2 presents the methodology of credit constraints; section 3 presents the results and discussion; and section 4 concludes the paper and provide some recommendations to enhance SMEs probability to access to bank loans.

## 2. Methodology

### 2.1. Theory of credit rationing

The classical economic theory suggests that credit is a scarce resource hence credit supply depends solely on lender's risk assessment over borrowers opportunity cost of loans, i.e. the interest rate, the equilibrium of credit supply and demand depends on the interest rate. However, Stiglitz and Weiss (1981) argued that the classical theory of supply and demand failed to explain the credit market because credit supply (i.e., banks and financial intermediations so called the lender) depends not only on the interest rate but also on the lender's evaluation of the borrower's trust worthiness based on the borrower's information.

To illustrate the point, we start with the argument that interest rate not only positively contributes to bank profits but also negatively influences bank profits through risk. According to Stiglitz and Weiss (1981), the negative effect involves two forms: (1) the lending rate affects the degree of risk of the loan due to adverse selection; and (2) rising the interest rate increases the incentives for borrowers to invest in higher-risk projects due to moral hazard.

There are many investors and there is a project that requires investment  $k$  under the market conditions. Each investor has assets  $W < k$  and the investor needs a loan to invest in a lucrative project, with an expected return  $R$  but with varying degrees of risk. In this, the successful project gains profit at  $R^*$  and the failure gets 0. The probability of success is  $p_i$  and the probability density function of  $p_i$  is  $f(p_i)$ . The loan is described by the equation:  $L = W - k$  and designed under a loan contract with a maturity value of  $(1+r)L$ . Its expected return satisfies the condition:  $R_i^* > (1+r)L$ .

Because of asymmetric information, investors know the probability of success of the project better than the bank. The expected return for investor  $i$  is:

$$E(\pi_i) = p_i(R_i^* - (1+r)L) \quad (1)$$

Expected return of the bank is:

$$E(\pi_b) = (1+r)L \int_0^p p_i f(p_i) dp_i \quad (2)$$

where  $p_i$  is the probability of the borrower  $i$  that is accepted by the bank. Expected return of investor  $i$  is:

$$E(\pi) = R - p_i(1+r)L \quad (3)$$

The investor  $i$  with high risk is willing to pay higher costs for loans. Therefore, the loan contract is signed if:  $E(\pi_i) \geq (1+\delta)W$  with  $\delta$  is an internal return ratio of the investment.

Assuming that high profit margins associated with high marginal risk, which implies that:

$$\frac{dp}{dr} < 0$$

The effect of interest on bank profits is:

$$\frac{dE(\pi_b)}{dr} = L \int_0^p p_i f(p_i) dp_i + \left( \frac{dp}{dr} \right) (1+r)L p f(p) \quad (4)$$

The first component on the right hand side of equation (4) shows that rising interest rate increases the borrower's debt-repayment rate. The second part implies that high interest rate reduces the quality of the loan. Bank maximizes

profit under the following condition.

$$\frac{dE(\pi_b)}{dr} = 0 \quad (5)$$

The result is illustrated in Figure 1. The left side of Figure 1 shows the combination of interest rates and expected returns, which is explained in the model of Hodgman (1960). The maximum profit of the bank is determined at the optimum interest rate, after that, profit is reduced due to the negative impact of interest on profit.

The right side of Figure 1 shows the combination of the demand and the supply curves of bank loans. The supply curve relates to the profit curve on the left side of Figure 1, whereby the supply quantity of loans increases with the interest rate so that increases the expected return but then the expected return decreases when the interest rate overtakes interest rate  $r_M$ . The demand line slopes downward at interest rates and intersects the supply curve at the rate that is higher than the profit maximizing rate  $r_M$ . In case of the demand curve intersects the supply curve at  $r_M$ , credit constraint does not exist. This is a stable equilibrium but not an equilibrium at bank's maximum profit because the bank can increase profits by reducing interest rates  $r_M$ . The maximum credit supply occurs at a point  $L_M$  which is lower than the interest rate at C. At  $r_M$ , demand for credit is greater than credit supply by the range of  $D_M - L_M$ . As a result, the bank must impose a credit constraint on some borrowers. Two types of credit constraints includes (i) type 1 (also known as partial-credit-constraint) occurs when borrowers are able to borrow an amount lesser than their demand at the market interest rate; (ii) type 2 (or complete-credit-constraint) occurs when borrowers are not able to borrow upon their credit demand.

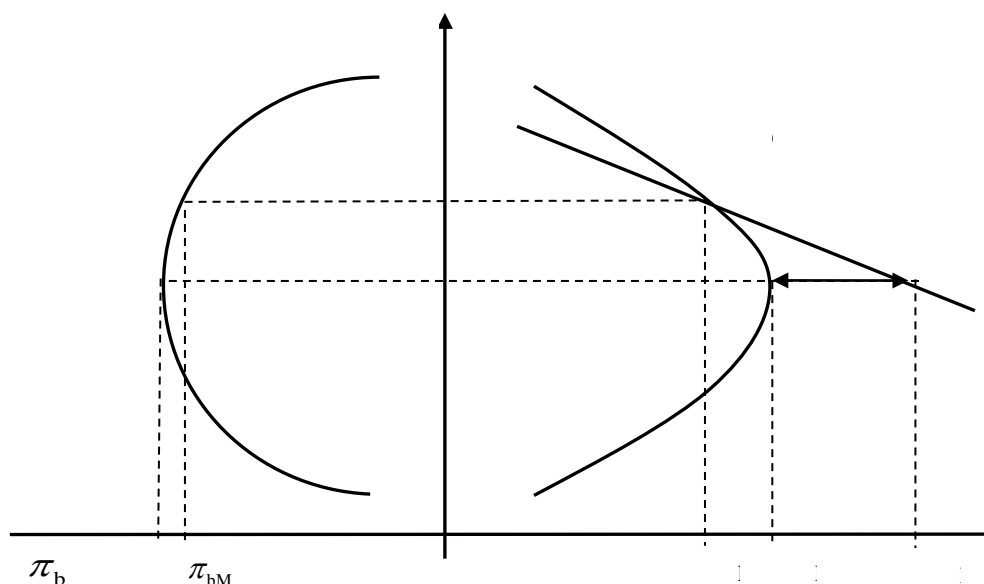

Figure 1. Credit constraints

In short, credit flow depends on market structure and the nature of asymmetric information. Adams and Vogel (1986) argued that when credit markets were centrally managed, information was less dispersed, transaction costs were high, lending decisions tended to be rigid, and complete-credit-constraint appeared. In contrast, with the level of fragmented information and flexible financial markets, low transaction costs of lending commonly created partial-credit-constraints. Typically, CIs rely on the available information of enterprises in the credit files to make a screening decision.

Next, we define  $V_i = D_i - S_i$  as the amount of credit demand exceeds the amount of credit supply; wherein,  $D_i$  is the amount of money that business  $i$  needs and  $S_i$  is the amount of money that the CI accepts for the business  $i$  borrows in terms of maximum lending.

A general model to analyze the likelihood that an enterprise  $i$  meets a credit constraint is written as:

$$V_i = \mathbf{x}_i' \boldsymbol{\beta}_i + u_i \quad (6)$$

Where,  $\mathbf{x}_i$  is a vector of variables that explain the likelihood of the credit constraint of the enterprise,  $\boldsymbol{\beta}_i$  is a vector of parameters and  $u_i$  is the error term. Although  $V_i$  is unobserved as the SMEs' excess credit demand is not realized, SMEs' credit constraint is observable through a questionnaire. Hence,  $\boldsymbol{\beta}_i$  are estimated by using a probabilistic model of which the dependent variable is specified based on the SMEs' levels of credit constraint.

In order to identify the level of credit constraint in SME, we define "credit unconstrained group" are SMEs that did not need to obtain external funds or that did not have any problems obtaining a loan as required. In the same maner,

SMEs that applied for a loan but were refused or they needed to borrow but did not apply because they were unqualified for a loan application are defined as “complete credit constrained group”. We further define “partial credit constrained group” are SMEs that applied for a specified loan amount but did not receive the exact amount as specified in the loan application.

## 2.2. Analytical model

The majority of experimental studies used the binary logit model (Ahiawodzi and Sackey, 2013), the probit model (Fenwick and Lyne, 1998; Agostino et al., 2008) to estimate the type 2 of credit constraint. However, the estimated results only explained the difference in the impact of the factors between the complete-credit-constraint group (type 2) and the unconstrained group and generally ignored the partial-credit-constraint group (type 1). This study used a multinomial logistic regression model to estimate the explanatory variables in the credit constraint models of type 1 and type 2 as defined in equation (6). The form of general model is:

$$\Pr(Y_i = j | \mathbf{x}_i) = p_{ij} = \frac{\exp[\mathbf{x}'_i \beta_j]}{\sum_{j=0}^J \exp[\mathbf{x}'_i \beta_j]} \quad j=0, \dots, J \quad (7)$$

where,  $i$  represents the number of observations;  $\mathbf{X}_i$  is a set of factors that affect the likelihood of a credit constraint (defined in Table 1);  $j = 0, \dots, J$  is a set of credit constraint levels on the assumption that they occur independently;  $\beta_0, \beta_1, \dots, \beta_J$  is a set of estimated coefficients corresponding to each type of credit constraints. Because of  $\sum p_{ij} = 1$ , so one of the estimated coefficients has to be set to zero so that the remaining coefficients can be estimated (Greene, 2012).

When  $J = 1$ , the equation (7) becomes a binary logit model with the dependent variable accepting two levels of value:  $Y_i = 1$  to be constrained or  $Y_i = 0$  to be unconstrained. The form of binary logit equation is:

$$\Pr(Y_i = 1 | \mathbf{x}_i) = p_{i1} = \frac{\exp[\mathbf{x}'_i \beta]}{1 + \exp[\mathbf{x}'_i \beta]} \quad (8)$$

When  $J = 2$ , the equation (7) becomes a multinomial logit model with three levels:  $Y_i = 2$  to be in complete-credit-constraint (type 2), or  $Y_i = 1$  to be in partial-credit-constraint (type 1), or  $Y_i = 0$  to be unconstrained. The form of multinomial logit equation is:

$$\Pr(Y_i = j | \mathbf{x}_i) = p_{ij} = \frac{\exp[\mathbf{x}'_i \beta_j]}{1 + \sum_{k=1}^{k=2} \exp[\mathbf{x}'_i \beta_k]} \quad j=0, 1, 2 \quad (9)$$

The coefficients  $\beta$  in equations (8) and (9) are estimated by the maximum likelihood estimation (MLE) followed Greene (2012). The marginal effects at the mean are calculated based on Cameron and Trivedi (2010) and are used to explain as the degree of influencing factors on credit constraints.

The information of credit constraints of SMEs is not directly retrieved from the 2015 survey data hence the dependent variable is recoded in order based on Figure 2. Hence,  $V$  takes the following values: 0 for unconstrained group; 1 for partial constraint group; and 2 for complete constraint group (Figure 2).

The specification of explanatory variables is based on the following assumptions. First, one the supply of credit it is clear that banks use the borrowers' information to allocate credit. We assume that banks cannot use the full information so that banks use sector-specific information (namely ownership, legal status and other easily observable characteristics, etc.) provided by the borrowers to predict of the borrower's probability to repay. We further assume that the banks have access to information on the current formal debt position and on the capital of the firm, which they can use to assess its current net worth and the ability to provide collateral for loans. We use the debt-capital ratio as our measure of the firm's formal debt position. At least two arguments can be advanced as to how this variable will affect credit supply. High rates of debt may reduce the willingness of the financial sector to satisfy the demand for credit of the firms, since the risk of bankruptcy may be higher. Conversely high debt ratios may be a signal of credit worthiness.

Second, a standard model of underinvestment and credit market imperfections can give us guidance on the variables to include in the model. Controlling for risk attitudes, firms will invest if the expected return exceeds the cost of using funds for investment. In an economy without either credit market imperfections, or adjustment costs, only unanticipated changes to the conditions faced by the firm in the economy should matter for net investment. However, this would not be the case if credit markets are imperfect. In that case, the returns to investment, the cost of external funds as well as the opportunity cost of using internal or other sources of funds are likely to be different and matter for investment demand, and by implication for the demand and supply of credit. The demand for credit will therefore be modelled as a function of firm-specific variables affecting the differences between the returns on capital to the firm and the cost of capital to the firm (Bond and Meghir, 1994; and Caballero et al., 1995).

As firms' credit constraints are observed under market clearance condition given their own heterogeneity, we use

explanatory variables to control for firm heterogeneity into equation (6). These can be interpreted as proxies for transactions costs in applying for loans so they will affect the demand for credit, and as proxies for the enforcement and monitoring costs which will influence the supply of credit.

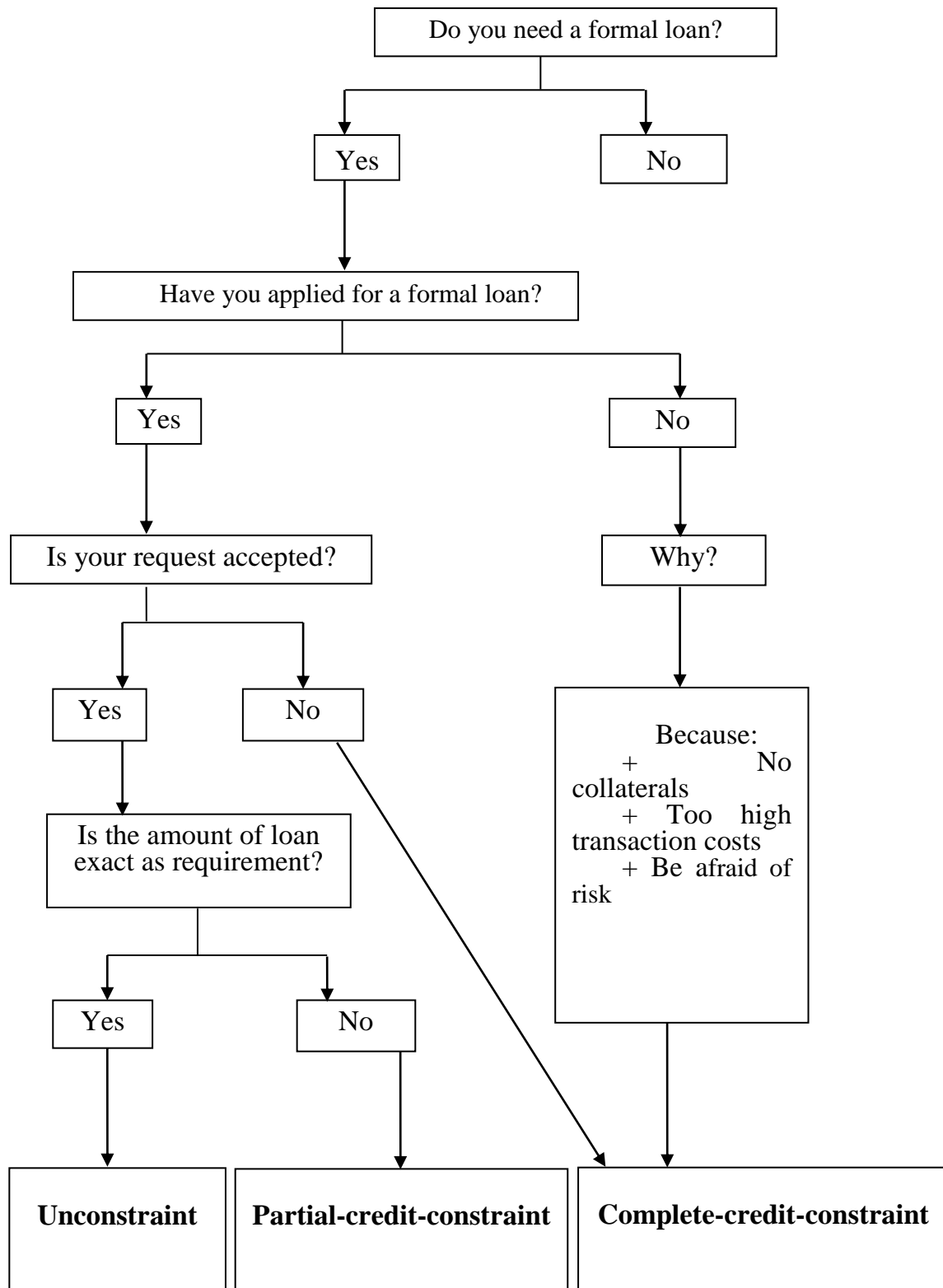

Figure 2. Identification of the levels of credit constraint

Table 1. Description of variables

Name of variables	Description	Experimental Research
<b>Dependent variable</b>		
Levels of credit constraint	0 for unconstraint group 1 for partial-credit-constraint group 2 for complete-credit-constraint group	
<b>Explanatory variables</b>		
<b>1. General information</b>		
Age of enterprise	Years of operation (years)	Beck and Cull (2014), Vuong Quoc Duy (2016)
Logarithm size of enterprise	Scale of the enterprise based on the value of total assets (billion VND)	Titman and Wessels (1988), Jordan et al. (1998)
Business registration certificates	Get value 1 if the enterprise has business registration certificate since its inception, the reverse value is 0	CIEM, DoE and ILSSA (2014)
Relationship with governmental institutions	Get value 1 if the business has a relationship with government/unions, the opposite value is 0	Casson and Giusta (2007), Agostino et al. (2008)
Participation in economic and social association	Get value 1 if the enterprise is a member of the socio-economic association, the reverse value is 0	
<b>2. Information on business operations and financial performance</b>		
The total assets turnover ratio	Ratio between net sales and total assets (%)	Atman (1968), Titman and Wessels (1988)
Number of formal loan refusals	Number of times a business is refused loans by CIs (times)	
Undue repayment	Get value 1 if the business does not pay on time; other cases receive 0	Cheng and Degryse (2010)
Having informal loans	Get value 1 if the business has an informal loan while applying for a loan, otherwise, get 0	Zeller (1994), Ajagbe (2012)
Lenders of the enterprise	Number of people/CIs/enterprises that regularly lend to business (creditors)	
Not to have collateral assets	Get value 1 when the business does not have collateral to get a loan, otherwise, get 0	Chan and Kanatas (1985), Petrick (2004), Okurut et al. (2011), Vuong Quoc Duy (2016)
<b>3. Information on the owner/manager</b>		
Age of owner/manager	Age of the manager/owner up to the study time (age)	Berger and Udell (1998), Tambunan (2011), Ajagbe (2012), Vuong Quoc Duy (2016), Hoque et al. (2016)
University level up	Get value 1 if the highest level of education of the owner/manager from university or above; other cases, get 0	
Attitudes towards risk	The level of being willing to take risk of the manager/owner by standardized value <sup>(a)</sup>	Dohmen et al. (2008), Falk et al. (2016)
<b>4. Information of the most important formal loan</b>		
Short-term maturity	Get value 1 when the term of the loan is less than or equal to 12 months; other cases, get 0	Berger and Udell (1998), Ahiawodzi and Sackey (2013)
Not to apply for any loans yet	Get value 1 when a business has never borrowed from the CI, where applying for a loan, otherwise, get 0	Ajagbe (2012), Beck and Cull (2014)
Loan guarantor	Get value 1 when the loan is guaranteed, otherwise, get 0	Berger and Udell (1998), Hoque et al. (2016)

Source: The author synthesized and processed data from the SME survey in Vietnam, 2015

Note: Group IV contains the information relating to the largest loan (in terms of value) of the business for the years 2014-2015.

<sup>(a)</sup>Calculation of standardized value (z):

$$z = \frac{X - \mu}{\sigma}$$

where X: The level of being willing to take risk of the manager/owner on the Likert scale of 11 (0-10);

$\mu$ : The average level of being willing to take risk of the sample;

$\sigma$ : Standard deviation of the level of being willing to take risk of the sample.

Moreover, the "credit" in "credit constraint" only includes formal commercial lending, excluding discounting, factoring, bank guarantees, financial leasing and other credit grants.

### 2.3. Data

The data in this study was retrieved from the SME survey, which was conducted by the Central Institute for Economic Management (CIEM), the Institute of Labour Science and Social Affairs (ILSSA), the Department of Economics (DoE) of the University of Copenhagen and UNU-WIDER with the Royal Embassy of Denmark in Vietnam in 2015. This nationwide enterprise survey was conducted every two years in Vietnam from 2005. Data were collected through direct interviews with 2,649 non-state manufacturing and processing SMEs in 10 provinces, namely Hanoi, Ha Tay, Hai Phong, Phu Tho, Nghe An, Quang Nam, Khanh Hoa, Lam Dong, Ho Chi Minh City and Long An. The sample of the 2015 SMEs survey was selected using stratified random sampling design based on the form of legal ownership.

The 2015 SME survey data contains sufficient information on SMEs loans although the information need to be recoded based on the definition of credit constraints. Of the total number of SMEs in the survey, 1,393 observations that did not need a loan during the period from August 2013 to August 2015; and 116 observations that borrowed and completely repaid in 2013 were eliminated. In addition, 18 observations with a total capital of over 100 billion VND were not considered as SMEs according to Decree 56/2009-CP, and 4 observations that had insufficient information were also excluded from the sample. Thus, the data to be used for the study consists of 1,118 observations (Table 2).

**Table 2. Number of enterprises by size and location**

Province/City	Micro Size	Small Size	Medium Size	Total	Density (%)
Ha Noi	73	74	1	148	13.24
Ha Tay	124	60	0	184	16.46
Hai Phong	58	32	1	91	8.14
Phu Tho	93	11	0	104	9.30
Nghe An	151	46	0	197	17.62
Quang Nam	48	14	0	62	5.55
Khanh Hoa	15	15	2	32	2.86
Lam Dong	15	14	0	29	2.59
Ho Chi Minh City	121	112	4	237	21.20
Long An	24	10	0	34	3.04
<b>Total</b>	<b>722</b>	<b>388</b>	<b>8</b>	<b>1,118</b>	<b>100</b>

Source: Synthesized from SME survey data, 2015

Note: Unit of the columns is "business", except the "Density" column.

Business size is classified based on the average number of employees in accordance with Decree 56/2009/CP

## 3. Results and discussion

### 3.1. Overview of the business environment and credit constraint situation of SMEs

The survey shows that the majority of enterprises established under the Enterprise Law have business registration certificates since their establishment. It is noteworthy that one half of the total number of enterprises do not have business registration certificate at the time of inception. The number of household enterprises operating but not registered with the competent authorities (also referred to as informal household enterprises) accounts for more than 90 percent (Table 3). In fact, having no business registration certificate not only creates difficulties in local management but also affects the benefit of enterprises, especially accessing to official capital resources, developing assistance programs of the State and socio-economic organizations for SME groups.

**Table 3. The enterprise has a business registration certificate when it is established, by legal form**

Legal form of enterprise	Have a business registration certificate		Not to have a business registration certificate	
	Frequen cy	Percentage (%)	Frequen cy	Percentage (%)
Household business	168	26.50	452	93.39
Private enterprise	72	11.35	6	1.24
Cooperative/Partnership	23	3.63	2	0.41
Limited liability company	300	47.32	18	3.72
Joint stock company	71	11.20	6	1.24
<b>Total</b>	<b>634</b>	<b>100</b>	<b>484</b>	<b>100</b>

Source: SMEs survey data in 2015

Table 4 shows that more than 94 percent of SMEs faced many difficulties in the process of business development. In particular, lack of funds/credit is considered as one of the top obstacles, just behind the disadvantage of fierce and unhealthy competition issues. Studies by the Central Institute for Economic Management (CIEM) and colleagues (CIEM, DoE and ILSSA, 2014) also reported similar results. This shows that for many years, the shortage of capital, especially loans has been a headache problem, hindering the development of the majority of SME in our country.

**Table 4. Main obstacle of the development of SMEs in Vietnam**

Difficulty	Frequency	Percentage (%)
Too much competition/unfair competition	340	32.23
Lack of capital/credit	325	30.81
Limited demand for goods/services/reduced orders	185	17.53
Unstable mechanisms and policies of the State	20	1.90
Too many interventions by local officials	5	0.47
Difficult to get certificates/licenses	3	0.28
Other	177	16.78
<b>Total</b>	<b>1,055</b>	<b>100</b>

Source: SMEs survey data in 2015

Table 5 shows that only 56.9 percent have access to loans from banks and formal CIs among the SMEs accessed loans while more than 43.1 percent that have demand for formal loans but only borrowed informal loans.

**Table 5. Characteristics of loans of SMEs**

Enterprise size	Micro	Small	Medium	Total	Density (%)
Formal loan	164	129	5	298	26.65
Informal loan	283	95	1	379	33.90
Formal and Informal loan	93	108	2	203	18.16
Not be able to get any loan	182	56	0	238	21.29
<b>Total</b>	<b>722</b>	<b>388</b>	<b>8</b>	<b>1,118</b>	<b>100</b>

Source: SMEs survey data in 2015

Note: Unit of the columns is "business", except the "Density" column.

Although, many solutions to help the SME community gain more access to formal credit, more than 60 percent of the SMEs faced complete credit constraint high. Of which, more than 99 percent small and micro enterprises face complete credit constraint (Table 6).

**Table 6. Formal credit constraints of SMEs**

Firm size	The unconstraining group		The partial-credit-constraint group		The complete-credit-constraint group	
	Frequency	Percentage (%)	Frequency	Percentage (%)	Frequency	Percentage (%)
Micro	232	52.02	25	45.45	465	75.36
Small	207	46.41	30	54.55	151	24.47
Medium	7	1.57	0	0.00	1	0.17
<b>Total</b>	<b>446</b>	<b>100</b>	<b>55</b>	<b>100</b>	<b>617</b>	<b>100</b>

Source: SMEs survey data in 2015

Table 7 provides reasons why SMEs faced difficulties to obtain a loan. A few SMEs gave reasons more closely related to being constrained as 9.5 percent did not have sufficient collaterals and 25.9 percent answered that the lending process is too much complicated, and 20.5 percent quoted interest rates were too high.

**Table 7. Problems of approaching formal loans**

Reasons	Frequency	Percentage (%)
Difficulties due to administrative procedures	161	23.96
Psychological fear of owed	145	21.58
Too high interest rates	138	20.54
Lack of collaterals	64	9.52
No full proof of the potential of the business	16	2.38
Being in full-debt situation	13	1.93



Complicated regulations of the State	13	1.93
Other	122	18.16
<b>Total</b>	<b>672</b>	<b>100</b>

Source: SMEs survey data in 2015

Out of the 527 SMEs applied for loans, there were more than 93.5 percent have collateral assets, equivalent to 493 cases. Land is the most common form of collaterals (57.4%) followed by private property, machinery, equipment and housing (Table 8).

**Table 8. Forms of collateral of the most important loan of the enterprise**

Forms of collateral	Frequency	Percentage (%)
Land (with certificate of right of land use)	283	57.40
Private property	74	15.01
Machine and equipment	69	14.00
Housing	49	9.94
Other	18	3.65
<b>Total</b>	<b>493</b>	<b>100</b>

Source: SMEs survey data in 2015

### 3.2. Estimated results

SMEs credit constraints were estimated using a binary logistic model in which the dependent variable takes 0 for unconstrained group and 1 otherwise (named model 1); and a multinomial logistic model in which the dependent variable were defined in Table 2 (named model 2) and the result were reported in table 9. The LR test showed that at least one independent variable influenced the value of the dependent variable in the models when rejecting the  $H_0$  hypothesis at 1% significant level. Thus, the results of the estimation of the independent variables in the models are reliable to explain the problem of the official credit constraint of the SME.

The model (1) has 10 significant variables: logarithm size of enterprise, relationship with governmental institutions, number of formal-loan refusals, having informal loans, lenders of the enterprise, not to have collateral assets, age of owner/manager, short-term maturity, not to apply for any loans yet and loan guarantor. In model (2a), there are 5 variables that are statistically significant: age of enterprise, business registration certificate, number of formal-loan refusals, not to have collateral assets and not to apply for any loans yet. There are 9 variables that are statistically significant in the model (2b), including logarithm size of enterprise, participation in economic and social association, number of formal-loan refusals, undue repayment, having informal loans, lenders of the enterprise, not to have collateral assets, age of owner/manager and not to apply for any loans yet (Table 9).

The marginal effect of age of enterprise is significant at the 5% level, implying that holding other factors constant if the longer the operating time of SMEs in business, the lesser the likelihood of being partial-credit-constrained (model 2a). This is in line with the findings of Beck and Cull (2014), Vuong Quoc Duy (2016). As the time of SMEs in business exist longer, the more assets are accumulated and the repayment capacity is higher.

The coefficient of logarithm size of enterprise is significant at the 10% level (model 1) and 1% (model 2b). The result implies that holding other factors constant, the larger the size of a business, the greater the cumulative value of assets, the higher the likelihood of being credit unconstrained.

The coefficient of business registration certificate is negative and significant at the 10% level (model 2a), implying that SMEs that face difficulty to access of formal loans due to not sufficient legal documents nor business registration are only able to obtain a small amount of credit compared to the amount of loan request.

The coefficients of relationship with governmental institutions and participation in economic and social association are both negative and significant at the 5% level (model 1) and 10% level (model 2b). This shows that the more relationships a business has with a socio-economic organization, the easier to access to a loan from CIs.

The coefficient of number of formal-loan refusals is positive and significant at the 1% in both models (1) and (2). The marginal effects indicate that when the number of times being refused by CIs increases the probability of SMEs being credit constrained by 45.7 percentage points (model 1) and 10 percentage points (model 2a) and 16 percentage points (model 2b).

The coefficient of undue repayment shows a negative correlation and is significant at the 5% level. The marginal effect of undue repayment implies that failure to repay on time slightly reduces 6.1 percentage points opportunity to access loans from CIs. In fact, the CIs will continue to review loan applications and still provide capital support to SMEs with growth potential to overcome temporary difficulties in business operations.

The variable having informal loans is negative and significant at the 1% level in models 1 and 2b. The marginal effect coefficient indicates that if SMEs had an informal loan while applying for a loan at a CI, it was likely to be restricted by the lending institution by 6.9 percentage points, holding other factors constant.

The variable lenders of the enterprise indicates that the number of individuals, businesses and CIs that regularly provide capital support or lend business finances. That can be seen as a factor in the credibility of the business. The result shows that as the number of capital supporters for the business increases, the likelihood of firms having credit constraints decreases by 0.9 percentage points (model 1), namely the possibility of not limiting total loan is 0.7 percentage point (model 2b), at the 1% level, holding other factors constant.

The marginal impact coefficient of not to have collateral assets shows that if the business does not have any asset for mortgage, the likelihood of firms having credit constraints increases 32.9 percentage points (model 1), 10.3 and 16.6 percentage points respectively in models (2a) and (2b), when other factors are constant (at the 1% level). In fact, securing loans by assets would greatly reduce the risk of loss of banks and CIs, which is usually required in most credit requests. This result resembles with Chan and Kanatas (1985), Petrick (2004), Okurut et al. (2011) and Vuong Quoc Duy (2016).

The coefficient of age of owner/manager is positive and significant at the 5% level in models (1) and (2b). Generally, the greater the age, the greater the accumulated experience but the increasing of age is also often associated with health issues and the accuracy of decisions, especially related to business operations. So that, the decision of CIs is pretty cautious about financing SME with older owners/managers. Meanwhile, the coefficient of short-term maturity is negative and significant at the 1%, indicating that CIs tend to finance short-term capital to SMEs.

The coefficient of not to apply for any loans yet is statistically significant in both models (1) and (2) at the 1%, when other factors remained unchanged. Although not to be complete-credit-constraint, the likelihood of partial-credit-constraint of the business increases by 5.5 percentage points if SMEs appear to be new applicants (model 2a). Usually, because of the lack of information on the history of borrowing, creditworthiness of customers, banks will check the information quite diligently before deciding to finance and tend to meet only part of the loan request for new businesses which apply in the first time.

The coefficient of loan guarantor is negative and significant at the 1% level in model 1. The marginal effect implies that if the loan is guaranteed, the likelihood of a credit constraint decreases by 49.8 percentage points. This result supports Berger and Udell (1998) with financial difficulties of small firms in the United States, Hoque et al. (2016) with lack of collateral of SMEs in Bangladesh.

**Table 9. Estimated results of the credit constraint model for SMEs**

Variable	Model (1)			Model (2)						
	Coefficient $\beta$	Standard error (S.E)	Marginal effect	Partial-credit-constraint (a)			Complete-credit-constraint (b)			
				Coefficient $\beta$	Standard error (S.E)	Marginal effect	Coefficient $\beta$	Standard error (S.E)	Marginal effect	
<b>I. General information</b>										
Age of enterprise	-0.008	0.012	-0.001	-0.058**	0.028	-0.001	0.007	0.016	0.001	
Logarithm size of enterprise	-0.143*	0.075	-0.012	0.209	0.160	0.006	0.262***	0.097	-0.017	
Business registration certificates	-0.246	0.257	-0.021	-0.957*	0.550	-0.023	-0.133	0.320	-0.004	
Relationship with governmental institutions	-0.485**	0.237	-0.042	-0.639	0.438	-0.014	-0.461	0.294	-0.025	
Participation in economic and social association	-0.232	0.347	-0.020	0.483	0.546	0.015	-0.679*	0.396	-0.043	
<b>II. Information on business operations and financial performance</b>										
The total assets turnover ratio	0.000	0.000	0.000	-0.000	0.000	-0.000	0.000	0.000	0.000	
Number of formal loan refusals	5.244***	1.014	0.457	4.460***	0.844	0.095	3.010***	0.896	0.160	
Undue repayment	-0.375	0.432	-0.033	0.719	0.628	0.022	-0.972**	0.446	-0.061	
Having		0.209	0.069	0.441	0.414	0.006		0.260	0.069	

informal loans	0.794***						1.184***		
Lenders of the enterprise	-						-		
Not to have collateral assets	0.099***	0.037	-0.009	-0.016	0.100	0.000	0.122***	0.041	-0.007
	3.775***	0.901	0.329	4.788***	0.957	0.103	3.127***	1.065	0.166
<b>III. Information on the owner/manager</b>									
Age of owner/manager	0.022**	0.011	0.002	0.022	0.020	0.000	0.028**	0.013	0.002
University level up	-0.026	0.280	-0.002	-0.022	0.550	-0.000	-0.054	0.328	-0.003
Attitudes towards risk	-0.007	0.103	-0.001	-0.209	0.205	-0.005	-0.024	0.126	-0.000
<b>IV. Information of the most important formal loan</b>									
Short-term maturity	-						-		
Not to apply for any loans yet	4.382***	0.266	-0.382	0.748	0.529	0.188	-38.872	535.998	-2.325
Loan guarantor	-						-		
Constant	2.714***	0.404	-0.236	1.217***	0.463	0.055	5.691***	0.799	-0.345
	5.721***	1.810	-0.498	-3.883	1.496	0.017	-25.486	12,941.6	-1.505
	2.321	0.731	-	-4.918	1.527	-	2.705	0.930	-
Log likelihood		-333.32						-320.62	
Prob > chi <sup>2</sup>		0.0000						0.0000	
Pseudo R <sup>2</sup>		55.67%						65.97%	
Predicted correctly percent		89.98%						90.25%	
Observations		1,118						1,118	

Note: \*, \*\*, and \*\*\* represent significant level at 10%, 5% and 1%, respectively.

#### 4. Conclusion

Access to credit is one of the major challenges for the development of businesses, especially the SME community. This research indicated that the factors related to the characteristics of the enterprise in general, such as age of enterprise, size of enterprise, business registration certificates, relationship with governmental institutions, participation in economic and social association, age of owner/manager, and the factors of borrowing history and financial status of the business, including the number of formal loan refusals, undue repayment, having informal loans, lenders of the enterprise, not to have collateral assets, short-term maturity, loan guarantor, not to apply for any loans yet impact on the official credit constraint of SMEs. In addition, the study showed the difference of several factors affecting the cases of partial-credit-constraint and being excluded from the list of customers of formal credit institutions. Thus, the results provide an empirical evidence on the credit constraint for SMEs, a common phenomenon in the credit market in Vietnam.

The results provide some implications. First, we found a very strong and significant firm size effect that micro firms are 43.8 percentage points likely to be credit constraint while 16.2 percentage points and 0.1 percentage points of being credit constraint for small enterprises and medium enterprises, respectively. Second, we also found a strong and negative effect of outstanding debt, implying that highly indebted firms are likely to seek for additional loans.

From the results, some recommendations are proposed to reduce SMEs credit constraints, including: (i) to improve SMEs business environment, in particular, to simplify administrative procedures of licensing for enterprises; (ii) the regulations of the State Bank on credit support should be more focused to SMEs demand by economic activities. Moreover, SMEs should actively resolve difficulties in their operation, create brand identity to reduce transaction cost in lending procedures. In addition, formal credit institutions should diversify their products so that the enterprises have more opportunities to access preferential loans. Furthermore, in the context of the global industrial revolution, besides completing traditional forms of transaction, formal credit institutions should rapidly launch new and modern payment services based on the application of information technology and telecommunications in order to shorten lending procedures to SMEs.

## Acknowledgements

The authors thank Pham Ngoc Toan, Deputy Director of Information, Strategic Analysis and Forecast Center, Institute of Labor Science & Social Affairs (ILSSA) for giving access to the SME 2015 data.

## References

- [1] Adams, D. & Vogel, R. (1986). Rural financial markets in developing countries: Recent controversies and lessons. *World Development*, 14, 477-487.
- [2] Agostino, M., Silipo, D.B., & Trivieri, F. (2008). The effects of screening and monitoring on credit rationing of SMEs. *Economic Notes by Banca Monte dei Paschi di Siena SpA*, 37(2), 155–179.
- [3] Ahiawodji, A.K. & Sackey, F.G. (2013). Determinants of credit rationing to the private sector in Ghana. *African Journal of Business Management*, 7(38), 3864-3874.
- [4] Ajagbe, F.A. (2012). Features of small scale entrepreneur and access to credit in Nigeria: A microanalysis. *American Journal of Social and Management Sciences*, 3(1), 39-44.
- [5] Atman, E.I. (1968). Financial ratios, discriminant analysis and the prediction of corporate bankruptcy. *The Journal of Finance*, 23(4), 589-609.
- [6] Beck, T. & Cull, R. (2014). SME finance in Africa. Policy Research working paper, No. WPS 7018. Washington, DC: World Bank Group.
- [7] Berger, A.N. & Udell, G.F. (1998). The economics of small business finance. *Journal of Banking and Finance*, 22, 613-673.
- [8] Bond, S. & Meghir, C. (1994). Financial constraints and company investment. *Fiscal Studies*, (2), 1-18.
- [9] Caballero, R., Engel, E. & Haltiwanger, J. (1995). Plant-level adjustment and aggregate investment dynamics. *Brookings Papers on Economic Activity*, 2, 1-54.
- [10] Cameron, A.C. & Trivedi, P.K. (2010). *Microeconometrics using STATA*, Revised Edition. Stata Press books.
- [11] Casson, M. & Giusta, M.D. (2007). Entrepreneurship and social capital. *International Small Business Journal*, 25(3), 220-244.
- [12] Chan Y.S. & Kanatas G. (1985). Asymmetric valuation and the role of collateral in loan agreements. *Journal of Money, Credit and Banking*, 17, 85-95.
- [13] Cheng, X., & Degryse, H. A. (2010). Information sharing and credit rationing: Evidence from the introduction of a public credit registry. *CentER Discussion Paper*, Vol. 2010-34S. Tilburg: Finance.
- [14] CIEM, DoE, and ILSSA, (2014). Characteristics of the Vietnamese business environment evidence from a survey in 2013. Ha Noi: Financial Publishing House.
- [15] Dohmen, T., Falk, A., Huffman, D., & Uwe, S. (2006). The intergenerational transmission of risk and trust attitudes. *IZA Discussion Paper*, 2380.
- [16] Falk, A., Becker, A., Dohmen, T. J., Huffman, D., & Sunde, U. (2016). The preference survey module: A validated instrument for measuring risk, time, and social preferences. *IZA Discussion Paper*, 9674.
- [17] Fazzari, S.M., Hubbard, R.G. & Petersen, B.C. (1988). Financial constraints and corporate investment. *Brookings Papers on Economic Activity*, 1, 141-195.
- [18] Fenwick, L. & Lyne, M.C. (1998). Factors influencing internal and external credit rationing among small-scale farm households in KwaZulu-Natal. *Agrekon*, 37(4), 495-505.
- [19] Greene, W. H. (2012). *Econometric analysis*. Boston: Pearson Education.
- [20] Hodgman, D. (1960). Credit risk and credit rationing. *Quarterly Journal of Economics*, 74, 258-278.
- [21] Hoff, K.R., Braverman, A. & Stiglitz, J.E. (1993). *The economics of rural organization: Theory, practice and policy*. Oxford University Press, Oxford University Press for the World Bank.
- [22] Hoque, M.Z., Sultana, N., & Thalil, T. (2016). Credit rationing's determinants of small and medium enterprises (SMEs) in Chittagong, Bangladesh. *Journal of Global Entrepreneurship Research*, 6, 1-23.
- [23] Hubbard, R.G. (1998). Capital-market imperfections and investment. *Journal of Economic Literature*, 36, 193-225.
- [24] Jordan, J., Lowe, J., & Taylor, P. (1998). Strategy and financial policy in United Kingdom small firms. *Journal of Business Finance & Accounting*, 25(1-2), 1-27.
- [25] My Phuong, (2016). Only 30% of small and medium enterprises have access to bank capital. *VietnamPlus Newspaper*.
- [26] Okurut, F.N., Olalekan, Y. & Mangadi, K. (2011). Credit rationing and SME development in Botswana: Implications for economic diversification. *Journal of Economics*, 8(12), 62-85.
- [27] Petrick, M. (2004). A microeconomic analysis of credit rationing in the Polish farm sector. *European Review of Agricultural Economics*, 31(1), 77-101.
- [28] Schiantarelli, F. (1996). Financial constraints and investment: Methodological issues and international evidence. *Oxford Review of Economic Policy*, 12 (2), 70-89.
- [29] Stiglitz, J.E. & Weiss, A. (1981). Credit rationing in markets with imperfect information. *The American Economic*

Review, 71(3), 393-410.

- [30] Tambunan, T.T.H. (2011). Development of small and medium enterprises in a developing country: The Indonesian case. *Journal of Enterprising Communities: People and Places in the Global Economy*, 5(1), 68 – 82.
- [31] Titman, S. & Wessels, R. (1988). The determinants of capital structure choices. *Journal of Finance*, 43(1), 1-19.
- [32] Vuong Quoc Duy (2016). The credit constraints of small and medium enterprises in Tien Giang province of Vietnam. *International Journal of Engineering Sciences & Management*, 6(1), 59-62.
- [33] Zeller, M. (1994). Determinants of credit rationing: A study of informal lenders and formal credit groups in Madagascar. *World Development*, 22(12), 1895-1907.

International Conference For Young Researchers In Economics And Business, ICYREB 2017, October 30<sup>th</sup> 2017  
Da Nang, Vietnam

# The Fourth Industrial Revolution: Fundamental Factors for The Transition of Vietnam's Industry

Nguyen Thai Hoa\*

Faculty of Finance – Banking and Business Management, Quy Nhon University, 170 An Duong Vuong, Quy Nhon City, Binh Dinh province, 820000, Vietnam

## ABSTRACT

This study was conducted to identify and assess the status of important factors for the transition of Vietnam's industry towards the fourth industrial revolution. The fundamental factors include: (i) Industrial restructuring; (ii) Innovation through R&D activities; (iii) The quality of human resources; (iv) Information technology infrastructure; and (v) The environment for Innovation. Those judgements are drawn through analyzing the information which has been assembled from the diverse data source over the period 1991-2017. The qualitative method is employed to study. Not only examining what the present internal problems of Vietnam are, we but also compare with other countries to have more objective views about the industry in Vietnam. By this approach, the findings show that these factors are currently at a low level, not able to meet the requirements of the industry 4.0. Therefore, the study proposes policy suggestions such as restructuring the industry; forming and developing venture capital funds; advancing the quality of human resources; improving information technology infrastructure; and reforming institutions. They are expected to speed up the process of Vietnam's industrial shift toward the modern, sustainable and innovative industry.

**Keywords:** The industrial revolution; Industry 4.0; Innovation; Vietnam's industry

## 1. Introduction

In the past, we had gone through 3 big industrial revolutions (IR), from mechanization, electrification to digital. Each IR helped significantly changing the structure of economic, political, culture and social system; in particular, it created dramatical shifts in productivity and improved the living standards of the world population. The IR 4.0 commonly known as "robotic" is surely expected to make the huge impacts, which are totally different, bigger, faster, more complicated than in the previous IRs. For the first time, breakthroughs in information technology, artificial intelligence, biotechnology, nanotechnology, etc. are combined to create the innovative technologies which significantly transform the industrial manufacturing in every country. They also innovate the entire producing, managing and governing system.

Although the achievements of IR 4.0 have been expected to become breakthroughs, Vietnamese industry has stayed the same after 30 years of Doi Moi, even relatively taken a backward step after the world. Manufacturing industries remain the fact of low labor productivity and value added as well as weak internal strength which mainly depend on FDI enterprises. The industrial labor productivity's growth rate for the period 2006 – 2015 is about 2,4% per year, lower than the overall average of 3,9%, and much lower than many regional countries. For example, the labor productivity of manufacturing in Malaysia and Thailand is 6,4 times, in the Philippines is 3,6 times higher than in Vietnam. Because of these facts, the question is what Vietnamese industry should do to apply achievements of IR 4.0 is still important to policy-makers. This study, therefore, is carried out to boost the transition of Vietnamese industry toward modern, sustainable and close to the world's industry.

The rest of paper is organized as follows: Section 2 discusses the literature review. Section 3 presents the methodology. Section 4 provides the overview picture about fundamental factors for the transition of Vietnam's industry while section 5 concludes and gives some implications.

\* Tel.: +84-934 759 076.  
E-mail address: nguyenthaihoa@fbm.edu.vn

## **2. Theoretical foundation**

### **2.1. Industrial Revolution 4.0 and its impacts to social economy**

IR and its impacts on the social economy have been the widespread issue in Vietnam and around the world. However, the global nowadays is at the first stage of IR 4.0, therefore according to author's knowledge, there has not been many studies which were carried out systematically, fully and deeply about both theory and practice of IR 4.0 and its developing trends, specific impacts together with necessary conditions to prepare for the future industrial production.

The most prominent research about IR 4.0 is a book of Klaus Schwab – Chairman of World Economic Forum, which describes a comprehensive picture, introduces all about IR 4.0, from the formation process, concepts, motivations, threats and opportunities of IR to its impacts on government, businesses, and people. According to Schwab (2016): “The 4th Industrial Revolution is characterized by a combination of technologies in the physical, digital and biology, creates entirely new and deeply influential capabilities which change the structure of the global economic, political, cultural and social systems. The world will witness the rise of artificial intelligence, with the abilities to replace human beings by robots in the judgement and management of complex systems.” This means that the 4th IR is not just a revolution happening in manufacturing sector, in businesses but also affects strongly on governments, people all around the world. These impacts are expected to be positive in long term, however, create many challenges in short and medium terms.

Economically, the 4th IR will impact dramatically on the manufacturing process, boost the global economy shift to the creative and knowledge-based economy. The new advances in science and technology will be applied to optimize production process, distribution, trading, and consumption. Many new business models will appear and destroy existing traditional models. The natural resource-based and cheap labor-intensive production strategies will gradually lose their advantages and be replaced by the re-shoring trends from the countries owning rich natural resource and cheap labor to the one with a lot of research and development (R&D) centers, skilled workers and near developed countries (UNIDO, 2015). This will make manufacturing sector in developing countries shrunken and business will be affected. In long term, it will lead to de-industrialization earlier in developing countries, including Vietnam.

From social perspectives, according to Schwab (2016), the IR 4.0 will promote the shift in the social labor structure, create the changing in employment both in structure and the nature of work with more and more initiatives in science, design, culture, arts, entertainment, communication, education, health, etc. About the employment, in the medium and long-term, low-skilled intensive sectors will be affected strongly and directly. It results from the increasing of high-skilled labor demand and the automation which can replace human power in almost economic activities, making a large part of employees will be redundant. The gap between the rich and the poor, social inequalities are likely to continue increasing, leading to further social conflicts. Problems in social security and employment will be focus points in many developing countries under the increasing influences of IR 4.0.

### **2.2. The fundamentals factors for boosting the industry towards IR 4.0**

According to Schwab (2016), IR 4.0 is the revolution of knowledge, innovation, and creativity. That means labor and capital have been declining their importance when comparing to the previous revolutions. In contrast, innovations and abilities to apply creativities from human knowledge into produce become key factors. In that sense, firstly, the production methods and structure are required to positively change to employ the advances of science, technology as well as innovations effectively. Industrial production has to shift from labor, capital and resource intensive to technology-intensive period and then to the creative industrial period (being capable of self-invention and self-design). Secondly, the level and ability of innovation in businesses, schools, and institutions have to be constantly improved by R&D activities. In other words, enterprises themselves have to innovate continuously, research actively, and apply smartly the advanced technology to increase productivity and value of products, upgrade the global competitiveness as well. Thirdly, promoting innovations in companies and education system require the direct role of human capital. UNIDO (2015) argued that improving the quality of skilled human resources was essential to adopt and apply successfully the revolution's achievements. They also emphasized the importance of young generation with the innovation, adapting ability to the working environment with robots.

Besides, it can not dismiss the role of information technology infrastructure since it is fundamental to boost the booming of IR 4.0 (Schwab, 2016). Information technology with high-speed connecting capability, big data, internet of things will be one of the main bridges to link the physical and biological applications in order to create the technical breakthroughs and changes in all industries, from manufacturing, trading to consumption. The state of the art innovation and technology infrastructure will be a leverage to offer industrial production many opportunities to catch up with the new trends in the world, such as circular economy, performance economy. Finally, the indispensable role of government is to create an environment which encourages and promotes innovation. In other words, it is the role of institutions in supporting economic development, encourages investment, business, and entrepreneurial spirit, etc. A weak economic institution will lead to a less attractive business environment, lack of incentives and hence lack of opportunities for innovation.

Thus, the key point in the 4th IR is that countries must have an encouraging innovation system, which applies the achievements of IR to transform the existing industry to the next stage, a higher position with greater added value, more productive, more competitive and sustainable. Along this study, the necessary fundamentals which can boost the current industry towards IR 4.0 include: (i) Shifting the industrial structure to the positive direction, (ii) Developing information technology infrastructure, (iii) Innovating through R&D, (iv) Improving the quality of human resources, (v) Creating an environment promotes innovation.

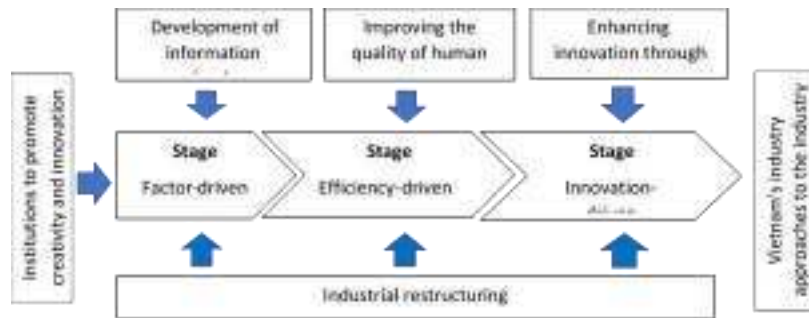

Fig. 1. The factors for the industrial transformation of Vietnam

Source: Author's collection

### 3. Method and Data

The main objective of this study is to identify the current status of critical factors for the transformation of Vietnam's industry in comparative relations with other countries in region having the same level as well as other developed countries. The factors for the transformation are determined based on literature reviews, and from that, we develop an analytical framework for Vietnam. The research method used in this study is, therefore, the qualitative method in which statistical, descriptive, comparative and analytical method will be employed to secondary data sources.

In order to guarantee the purpose of this study, the data are collected both for Vietnam and other nations. They are retrieved from the reports of some international organizations such as World Bank, World Economic Forum, The United Nations who supplied Global Competitiveness Report, Doing Business report, The information society report. Thus, they are accepted and used popularly as well as have high reliability. Besides, information about Vietnam is updated from General Statistics Office of Vietnam to serve for the evaluation of important factors that promote Vietnam's industry towards the fourth industrial revolution.

### 4. Access the fundamentals to transform Vietnamese industry toward IR 4.0

#### 4.1. Shifting to a positive industrial structure

According to Global Competitiveness Report 2016 – 2017 of World Economic Forum (WEF, 2016), with GDP per capita of N industry was still in the early stage of industrialization with mostly simple production, low added value and main contributors from FDI sector.

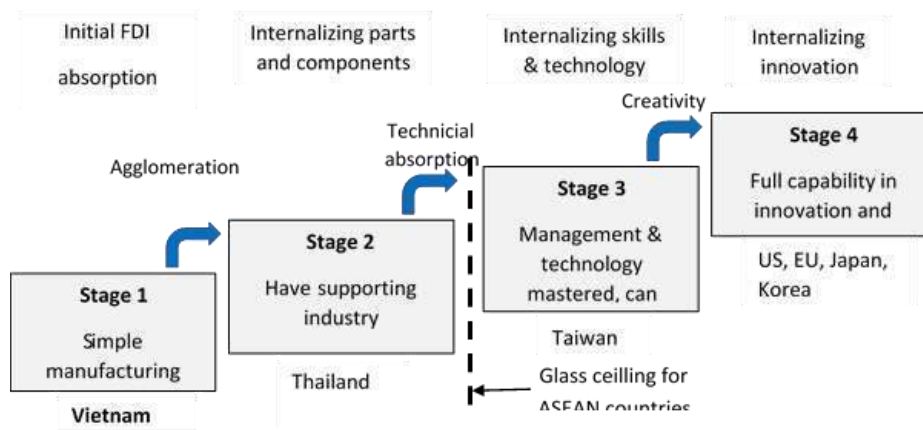

Fig. 2. Vietnam is at an early stage of industrialization

Source: Ohno (2010)



Figure 3 shows that share of FDI has been increasing by nearly 50% of total industrial production value, while this value in domestic manufacturing has been decreasing gradually.



Fig. 3. Contribution to the growth of industrial production value by sectors (fixed price)

Source: Vietnam Statistical Yearbook

There was an optimistic sign when export value of industrial products occupied nearly two-third of total export turnover in Vietnam (UNIDO, 2014). However, this figure must be at least 80% if Vietnam wants to become a high industrialization country like South Korea, Singapore, and China whose value is more than 90%. It is important that there was only 30% of 80% Vietnamese export industrial product earnings belong to high and medium technology. Although this kind of products positively raised from 20% in 2000-2005 to 30% in 2010, the pace was quite slower than Thailand, Malaysia, China, and even the Philippines. Vietnam is still far away from these nations where the rate of high and medium technology products are 50%-80%.



Fig. 4. Evolution of export structure towards manufactured exports and technology intensive exports for Vietnam and comparator, 2000 - 2010

Source: UNIDO (2012)

Besides, among Vietnamese goods having highest export value, the proportion of high and medium technology industrial products is mostly from FDI sector whereas the domestic sector contributes only a small percentage of added value in labor intensive industrial products, such as garment, footwears, wood and wood products, etc.

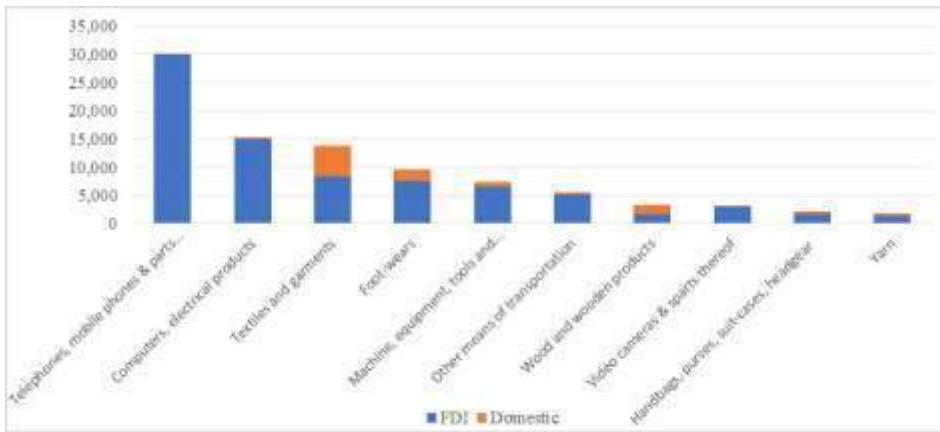

Fig. 5. Items of great export value in Vietnam (million USD), 2015

Source: Vietnamese General Customs (2015)

#### 4.2. Innovation through research and development activities

Regarding the rate of innovation (WEF, 2016), Vietnam ranked middle in most of indicators with the average score is 3.3/7, being lower than other countries as Thailand, Indonesia, and Malaysia. In 6 indicators of innovation capacity, Vietnam is only highly ranked in the category of Awareness of government on advanced technology procurement (27/130 countries), the remaining categories such as the Quality of research institutions, the Collaboration between universities and businesses in R&D, the Business’s spending for R&D are underestimated.

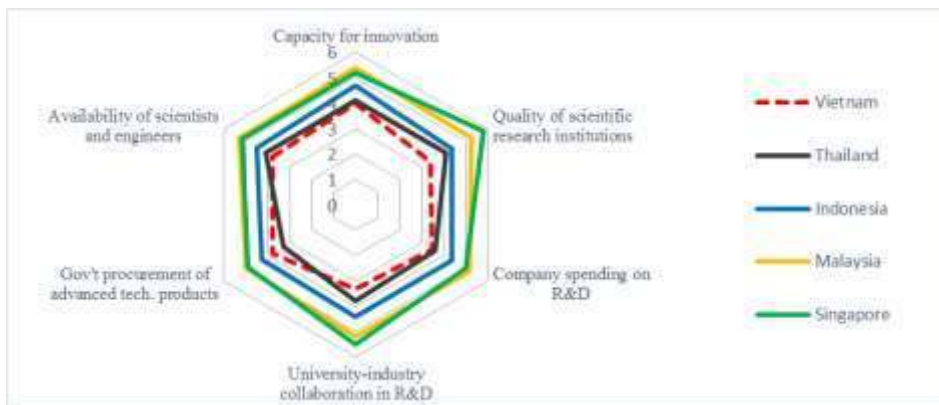

Fig. 6. Innovation and creativity in Vietnam and ASEAN countries

Source: WEF (2016)

Besides, Vietnam’s expenditure on R&D was quite low of 0.19%/GDP in comparison with the world average spending of 2.13%/GDP. In developed countries such as Japan and South Korea, the ratio was as very high as of 3.5% - 4% GDP. It showed that R&D activities in Vietnam had not received proper attention, without mentioning the quality of research activities and their applicability to society as well as the economy in general.

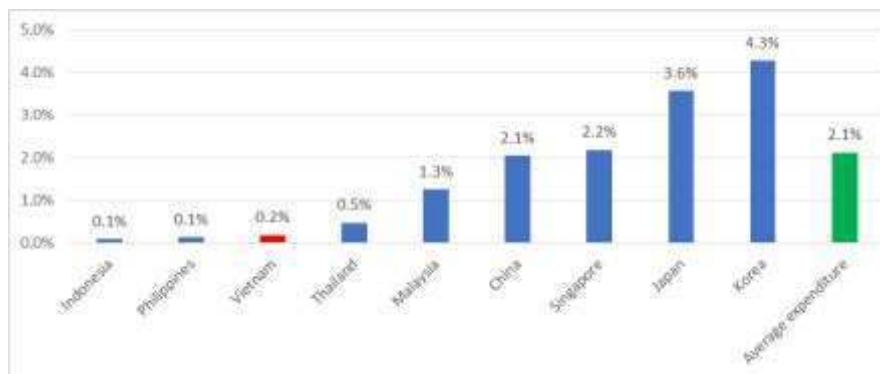
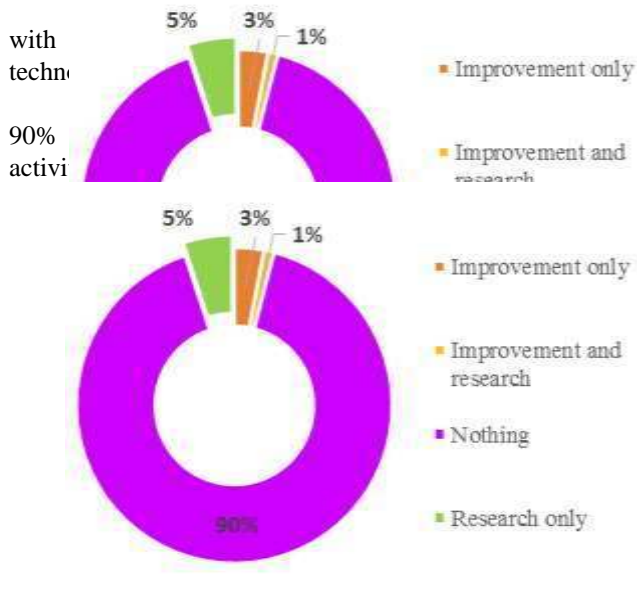

Fig. 7. Spending on R&D (% GDP)

Source: Tradingeconomics.com



**Fig. 8(a). The percentage of enterprises implement improvement and technological research**

ns do not occur, it will be difficult for Vietnam to catch up rld on activities of researching, innovating and creating etitiveness Survey 2013 (CIEM, 2014) illustrates that up to nnovation and research activities. Only 5% had research

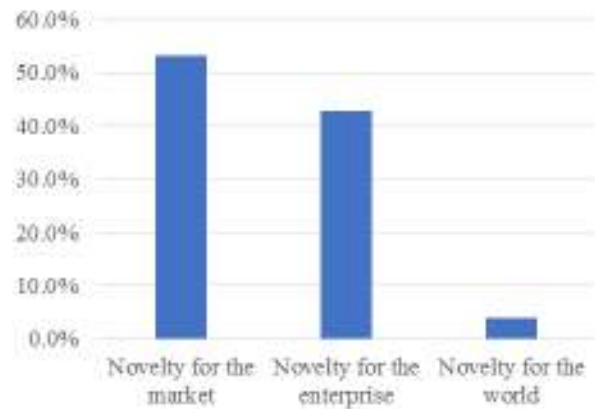

**Fig. 8(b). The novelty of the research product**

Source: CIEM (2014)

Moreover, regarding the novelty of the researched products, only 4% of the products among 9% of companies having research activities or technology innovation was new to the world, the rest was new to the firms themselves or to the markets only. It described that the researched products in Vietnam have been for local demands only, and international competitiveness was limited. Technology products in Vietnam, therefore, mainly have provided by FDI companies.

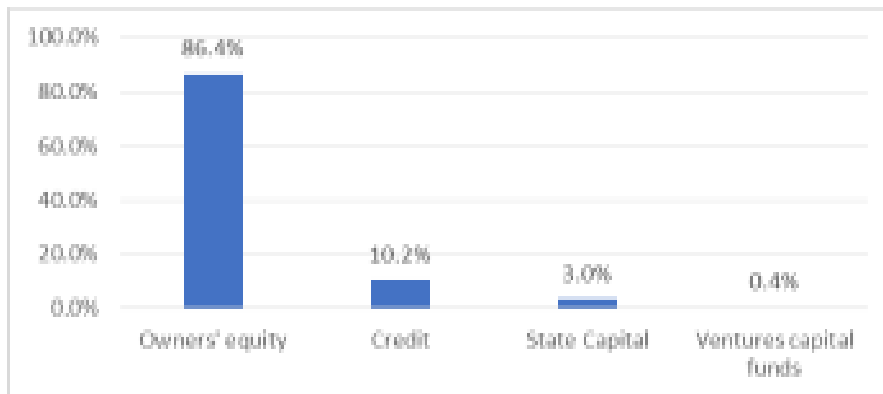

**Fig. 9. Funding for research and technological innovation in enterprises**

Source: CIEM (2014)

Furthermore, R&D activities in Vietnam were mainly financed by owner’s equity which accounted for over 85% of total funding. Meanwhile, the most critical source for these activities was adventure fund, being only 0.4%. This is the reason why more than 90% companies were not interested in R&D activities. They required a lot of time, generous budget, and many risks followed during the R&D process. Companies were reluctant to invest in “a gamble” where there was an uncertainty of success. The role of adventure fund – sponsoring to research and innovation activities, therefore, is essential. If the proportion of adventure fund is still low, it will restrain individuals and companies from promoting their creation through technology R&D projects. Concerning the existing status, we are employing backward products which are no longer used by developed countries, which means Vietnam would not catch up with other countries and reach the achievement of IR 4.0.

**4.3. Quality of human resource**

In order to grasp and apply the results of technology innovation, it requires that workforce’s qualification and

skills should be improved. According to the report on Global Competitiveness 2017 (WEF, 2016), Vietnam university-level education and training was assessed at the intermediate level, ranking 83 out of 138 countries, extremely lower than other regional countries like the first position of Singapore or the 41st, 62nd, 63rd of Malaysia, Thailand, and Indonesia respectively. Some criteria were identified at remarkably low compared with other regional countries. For instance, Quality at management universities and Availability of specialized training services in Vietnam were at a very low place of 122 and 110 out of 138, correspondingly.

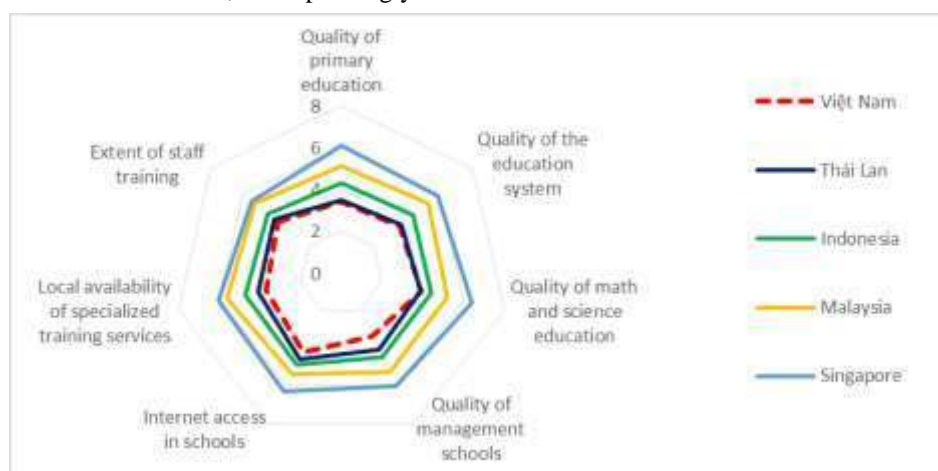

**Fig.10. Education and training of Vietnam in comparison with ASEAN countries**

Source: WEF (2016)

Based on the workforce classified by qualification in Vietnam, untrained labors accounted for 80% of employees, less than 10% of them completed universities and higher education. The situation of human resource is a huge challenge to Vietnam companies to transfer from resource-intensive to technology-intensive with innovation.

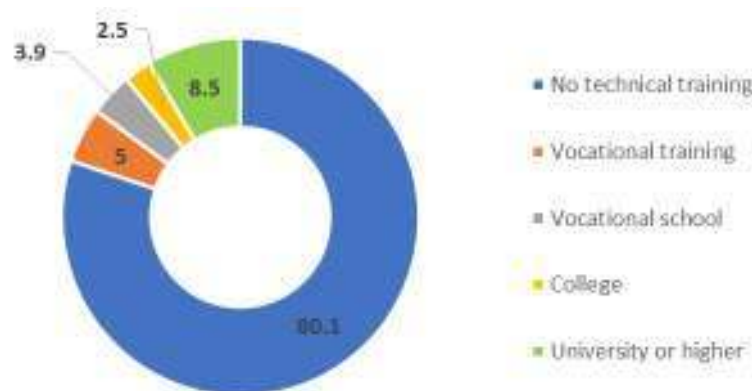

**Fig. 11. Employment structure by professional level (%)**

Source: General Statistics Office (GSO, 2016)

Moreover, about 38% of hired-employees were unskilled, nearly 40% were working in primary sectors such as personal services, security, and sales (16.6%); trained labors in agricultural and forestry and aquatic sector (10.3%); craft and other related jobs (12.8%). On the contrary, the rate of skilled and high-qualified labor was only 10%. The ratio implies that it will be difficult for Vietnam to take advantage of IR’s achievements if there are no significant changes in human resources.

**Table 1. The number of labours and occupational structure of employed people in Vietnam, 2016**

Occupation	Number of people employed (thousand people)	Percentage (%)		
		Total	Man	Woman
<b>Total</b>	<b>53302.8</b>	<b>100</b>	<b>100</b>	<b>100</b>
Leaders	555	1.0	1.5	0.6

Advanced technical expertise	3659	6.9	6.2	7.6
Intermediate technical expertise	1639	3.1	2.7	3.5
Staff	991.9	1.9	1.8	1.9
Personal services, security guards, sales staff	8861.4	16.6	12.3	21.2
Skilled workers in agriculture, forestry and fishery	5470.9	10.3	11.9	8.6
Craftsman	6827	12.8	17.7	7.6
Mechanizer and machine operator	4921.6	9.2	10.2	8.2
Simple labor	20247.8	38	35.4	40.8
Others	129.2	0.2	0.4	0.1

Source: GSO (2016)

#### 4.4. IT infrastructure

IT and communication infrastructure are fundamentals for the IR 4.0 development. In practical, Vietnam IT infrastructure has been developed in recent years. Some criteria on technology were assessed at a high level compared with the average level of other countries and the region. In detail, a quantity of cellphone numbers per 100 people was at a high level of 130.6/100 people, over 52% of the population were using the internet compared with the average rate of 42% in Asia-pacific region and over 1/3 population were using the broadband mobile phone. Even there were some improvements, these indicators were still lower than other developed countries such as Korea and Singapore. Besides, the number of households using computers and the internet was still low.

**Table 2. Vietnam's Telecommunications infrastructure compared to some countries in Asia, 2015**

	Vietnam	Thailand	Indonesia	Malaysia	Singapore	Korea	Asia & Pacific
<b>ICT access</b>							
Fixed-telephone subscriptions per 100 inhabitants	6.3	7.9	8.8	14.3	36	58.1	<b>11</b>
Mobile-cellular telephone subscriptions per 100 inhabitants	130.6	125.8	132.3	143.9	146.1	118.5	<b>93</b>
International Internet bandwidth per Internet user	24'374	64'907	6'584	34'119	737'006	46'764	
Percentage of households with a computer	22	29.5	18.7	67.6	87.5	77.1	<b>36</b>
Percentage of households with Internet access	24.1	52.2	38.4	70.1	89.5	98.8	<b>42.7</b>
<b>ICT use</b>							
Percentage of individuals using the Internet	52.7	39.3	22	71.1	82.1	89.9	<b>41.9</b>
Fixed-broadband Internet subscriptions per 100 inhabitants	8.1	9.2	1.1	9	26.5	40.2	
Active mobile-broadband subscriptions per 100 inhabitants	39	75.3	42	89.9	142.2	109.7	<b>37.7</b>

Source: ITU (2016)

IT application to production and business of companies has been improved. Particularly, the number of companies using website, email address or e-signatures has increased over the years. According to Vietnam e-commerce report

2014, up to 82.5% of surveyed enterprises used broadband internet and over 45% companies had their own websites.

**Table 3. Level of information technology application of the enterprise**

Quota	2012	2013	2014
<b>Percentage of enterprises having broadband Internet connection</b>	56.2	76.1	82.5
	%	%	%
<b>Using email in the enterprise</b>			
Under 10%		25	25
		%	%
11 - 50%		51	40
		%	%
Over 50%		24	35
		%	%
<b>Using electronic signature</b>	23	31	45
	%	%	%
<b>Percentage of enterprises with a website</b>	42	43	45
	%	%	%
<b>Businesses using means of electronic techniques for business</b>			
Using email	69	83	76
	%	%	%
Using website	31	43	39
	%	%	%
<b>Enterprises use online public services</b>			
Used			57
			%
Not used			43
			%

Source: Ministry of Industry & Trade (2014)

Meanwhile, in public, provincial, and municipal sections, there were some improvements in applying IT. Nonetheless, it was still at the low level and with slow speed. Only 50% staffs were provided with an email address and used it for business purposes. Also, only 1/3 of applications on IT such as one-gate system or e-signature were used in provinces and cities. In addition, criteria such as the number of computers per staff and the number of full-time IT staffs were still low.

**Table 4. The level of application of information technology in the public sector**

Quota	2016	2015	2014
<b>Technical infrastructure</b>			
Percentage of computers per a officer	0.69%	0.64%	0.67%
Percentage of Internet bandwidth per a officer, kbps	2488.5		
<b>IT human resources</b>			
Percentage of staff in charge of IT	1.00%	1%	1.10%
Percentage of staff in charge of information security	0.70%	0.60%	0.60%
Percentage of IT staff with university degree or higher	75.70%		
<b>IT applications</b>			
Percentage of officers with a official email box	51.30%	54.70%	52.90%
Percentage of officers using email at work	51.40%	51.90%	48.80%
Percentage of provinces with a website	100%	100%	100%
<b>IT application in public services</b>			
"One-stop shop" service	68.30%	58.70%	52.40%
Digital signature	76.20%	66.70%	47.60%

Source: Vietnam ICT Index, 2016

#### 4.5. Environment for innovation

The environment for innovation plays a crucial role in establishing and encouraging individuals and companies to promote the spirit of startup and entrepreneurs, that dares to think and to do. In a favourable business environment, transparent laws and regulations are introduced, supportive institution is implemented in disclosed and fair manner will bring many opportunities for initiatives and new ideas. It is also Vietnamese government's determination on creating a governance that facilitates conditions and trust of people and companies.

According to Doing Business 2017, Vietnam ranked at 82 out of 190 economies, climbing 9 spots from 2016, however, the business environment still lags far behind other regional countries such as Thailand (46/190), Malaysia (23/190), Singapore (2/190) (World Bank, 2017). Moreover, indicators of Vietnam business environment were lower than the average level of ASEAN 4. Some criteria such as new company establishment, tax payment, bankruptcy settlement, protection to small entrepreneur were ranked at low levels.

**Table 5. The quality of Vietnam's business environment in comparison with countries, 2017**

Rank/190	Vietnam	Thailand	Indonesia	Malaysia	Singapore	Korea
Starting a business	121	78	151	112	6	11
Dealing with construction permits	24	42	116	13	10	31
Getting electricity	96	37	49	8	10	1
Registering property	59	68	118	40	19	39
Getting credit	32	82	62	20	20	44
Protecting minority investors	87	27	70	3	1	13
Paying taxes	167	109	104	61	8	23
Trading across borders	93	56	108	60	41	32
Enforcing contracts	69	51	166	42	2	1
Resolving insolvency	125	23	76	46	29	4

Source: World Bank (2017)

Global Competitiveness Report from WEF (2016) indicates that the situation seemed to be even more serious. Vietnam stepped back 4 spots compared with the previous year (from 56 to 60), lower than ASEAN 6, only higher than Laos and Cambodia. Six ASEAN countries ranking higher than Vietnam were Singapore (2nd), Malaysia (25th), Thailand (34th), Indonesia (41st), the Philippines (57th) and Brunei (58th). In terms of criteria on institutional quality, unofficial expenditures, burden of administrative procedures and wastes in public spending ranked at the lowest levels. Moreover, according to WEF 2017, top 5 obstacles are (i) lack of knowledgeable labors; (ii) lack of stability on regulations and policies; (iii) tax regulations and procedures; (iv) tariff burden; and (v) difficulties in approaching administration system. These obstacles had been followed by corruption, bureaucracy of government, and lack of infrastructure, etc. In summary, with the institutional quality and business environment as above, it would be difficult for Vietnam to establish an environment for startup and creativity of individuals and companies if we do not have radical reforms.

**Table 6. The institutional quality of Vietnam compared to ASEAN countries**

Institutions (Score 1-7)	Vietnam	Thailand	Indonesia	Malaysia	Singapore
Property rights	4.0	4.0	4.4	5.3	6.3
Intellectual property protection	3.7	3.3	4.3	5.3	6.3
Public trust in politicians	3.6	2.2	3.6	4.3	6.4
Irregular payments and bribes	<b>3.3</b>	3.7	3.6	4.8	6.7
Judicial independence	3.5	4.0	4.1	4.6	5.6
Wastefulness of government spending	<b>2.9</b>	2.5	3.9	4.9	5.9
Burden of government regulation	<b>3.2</b>	3.5	3.9	4.9	5.6
Efficiency of legal framework in settling disputes	3.5	4.0	4.0	5.1	6.2
Transparency of government policymaking	3.8	3.9	4.3	5.1	6.3
Strength of auditing and reporting standards	3.6	4.9	4.4	5.3	6.3
Protection of minority shareholders' interests	3.7	4.5	4.3	5.1	5.7
Strength of investor protection	4.5	6.3	5.3	7.8	8.3

Source: WEF (2016)

In addition to two above-mentioned reports, Vietnam GEM 2015 showed a general picture about the environment, conditions of business development and startup spirit in Vietnam. In comparison with the same development level countries, business in Vietnam was more optimistic. Specifically, some criteria were much higher than the average of Asia-Pacific region (see detail in chart 11). However, there were four criteria still at a low level of Education, Government's assistance and finance for business. The results were identified as the same as the reports of WEF and World Bank when Vietnam still had some obstacles to education and institution. It also showed that Vietnam had to pay more effort to create an environment for encouraging and accelerating innovation, startup spirit.

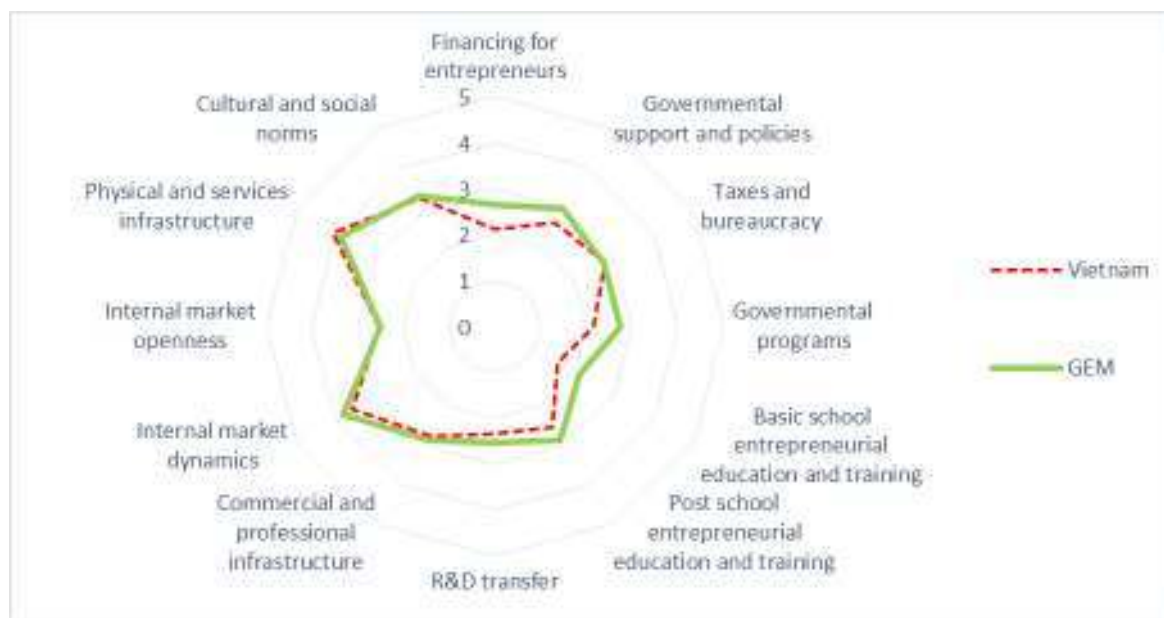

Fig. 12. The start-up ecosystem of Vietnam in comparison with Asia Pacific, 2015

Source: VCCI (2015)

## 5. Conclusion and Policy recommendation

### 5.1. Conclusion

Based on the above analysis on fundamentals accelerating Vietnam economic transformation, this study has the following conclusions: Firstly, Vietnam industry still concentrated on advantages of workforce and natural resources while these have been no longer benefits in the increasing IR 4. Secondly, level of innovation on R&D activities was not high. Of which, companies' capacity of participating in research and technology innovation was at low level, below 10%. The novelty of research products only satisfied company demands and domestic markets while it was at a very low level to the world. Moreover, funds, especially adventure funds, which were essential for R&D activities, only accounted a minor proportion, limiting the encouragement to companies. Thirdly, quality of human resources and education system has been low, not met the requirement of modern-oriented industry transformation. The rate of untrained labor accounted for over 80%; ratio of labor with intermediate and higher-level qualification was low at only 10% whereas over 50% workforce was working in unskilled sectors. Fourthly, IT infrastructure was improved; however, its application and popularity to companies and government sectors were not high and lower than other developed countries. Fifthly, environment and design for innovation have been improved, but some huge obstacles were not settled. Of which, there was a lack of qualified workforce, burden of administrative procedures, difficulties in assessing to financial source, lack of government's support, which restricted startup spirit and limited encouragement and innovation of people and entrepreneur community.

### 5.2. Policy recommendations

Analysing the status and barriers of Vietnam industry, the study recommends some solutions as follows:

- *Accelerating industry transformation* in a positive way, focusing on technology-intensive status and innovation.

In order to achieve this point, it is required to examine and reassess the industrialization as well as Vietnam industrial policies in the context of IR 4.0. Production strategies based on low-cost workforce and natural resources should be changed to productive, technology application, knowledge-based and creative one. Namely, the industrial



sectors which produce value-added products and exported products should widen. By contrast, the ratio of manufacturing sectors of processing and natural resource-based products should be decreased gradually. Secondly, establishing and developing high-technology sectors should be a fundamental of industrial transformation. Besides, encouraging companies to invest and change technology and apply science and technique should be conducted with government's assistance. Moreover, establishing an environment for connecting local firms with FDI ones is required to transfer, receive and take lead of technology.

- *Encouraging establishment and development of adventure funds.*

The Government must mobilize and introduce suitable policies on encouraging adventure funds in Vietnam to develop the capital market for startup innovation, R&D in companies as well. Political basis and favorite environment for adventure funds, therefore, are required. It will connect the network of adventure funds with each other and startup companies and entrepreneurs' community in order to share development opportunities as well as risks of new-technology sector.

- *Improving quality of human resource through quality and effectiveness of education system*

The education system should be improved in a way of promoting innovation, of which learners are the center, encouraging them to develop their ideas and creations during their studying. Besides, cooperation between universities and companies on teaching and search activities should be enhanced. Not only labors are trained as requested by the firms, but also companies are supported with technology and product development projects.

- *Improving IT infrastructure and enhancing IT applicability to economic – social activities*

Existing IT infrastructure should be improved more and more, focusing on human resources in order to meet the needs of IR 4.0; and strategies of IT development should be prepared at the same time in order to leapfrog IR 4.0's trend. Moreover, IT application to all sectors even in government-funded companies should be boosted, and IT should be considered as a basic fundamental of approaching IR 4.0.

- *Improving the institution in order to establish an environment encouraging innovation.*

Regarding establishing an environment for startups and innovation, the Government should provide strong changes in institution, directing to transparency and accountability; limiting barriers to investment and business; building a safe, fair and equitable business environment. Motivation to individuals and companies for endless innovation, therefore, is established, encouraging startups and reaching to a knowledge-based economy.

## References

- [1] Bộ Công Thương (2014). *Báo cáo thương mại điện tử Việt Nam 2014*. Hà Nội: Cục thương mại điện tử và Công nghệ thông tin.
- [2] Bộ Thông tin và Truyền thông (2016). *Báo cáo chỉ số sẵn sàng cho phát triển và ứng dụng công nghệ thông tin và truyền thông Việt Nam năm 2016*. Hà Nội: Vụ công nghệ thông tin và Hội tin học Việt Nam.
- [3] CIEM (2014). *Năng lực cạnh tranh và công nghệ ở cấp độ doanh nghiệp tại Việt Nam - Kết quả điều tra năm 2013*. Hà Nội: Nhà xuất bản Tài chính.
- [4] ITU (2016). *Masuring the Information Society Report 2016*. Geneva: International Telecommunication Union.
- [5] Ohno, K. (2010). *Avoiding the Middle Income Trap: Renovating Industrial Policy Formulation in Vietnam*, Asian Economic Bulletin, 26 (1), 25 – 43.
- [6] Schwab, K. (2016). *The fourth industrial revolution*. Geneva: World Economic Forum.
- [7] Tổng cục Hải quan (2015). *Niên giám thống kê Hải quan về hàng hóa xuất nhập khẩu Việt Nam 2015*. Hà Nội: Cục công nghệ thông tin và Thống kê hải quan.
- [8] Tổng cục Thống kê (2016). *Báo cáo điều tra lao động việc làm năm 2016*. Hà Nội: Nhà xuất bản Thống kê.
- [9] UNIDO (2014). *Viet Nam: Competitive Industrial Performance in 2012*. Ha Noi: UNIDO Viet Nam.
- [10] UNIDO (2015). *Industry 4.0: Opportunities and Challenges of the New Industrial Revolution for Developing Countries and Economics in Transition*. Vienna: Department of Trade, Investment and Innovation (TII).
- [11] VCCI (2015). *Báo cáo chỉ số khởi nghiệp năm 2015 - 2016*. Hà Nội: Nhà xuất bản Giao thông vận tải.
- [12] WEF (2016). *The Global Competitiveness Report 2016 - 2017*. Geneva: World Economic Forum.
- [13] World Bank (2017). *Doing business 2017: Equal Opportunities for all*. Washington DC: The World Bank Group.

International Conference For Young Researchers In Economics And Business, ICYREB 2017, October 30<sup>th</sup> 2017  
Da Nang, Vietnam

## **Developing scientific tourism in Binh Dinh Province: Launching from International Center for Interdisciplinary Science and Education (ICISE).**

**PhD. Dang Thi Thanh Loan\***

Division of Business Administration, Quy Nhon University, 170 An Duong Vuong, Quy Nhon, Vietnam

---

### **ABSTRACT**

The International Center for Interdisciplinary Science and Education (ICISE), a meeting point for the development of cooperation and sharing of experience between international scientists and Vietnamese researchers, which was put into operation in 2013, has become a favorite destination of science enthusiasts. Since its completion, more than 2,500 international scientists, including 11 Nobel laureates and professors and scientists from 35 different countries have come here. Linking science and tourism has emerged as an alternative development strategy that could meet the challenge of enhancing socio-economic growth of the local communities. This research aims at focusing on a relatively new phenomenon called Scientific Tourism. In Vietnam, this is a completely new phenomenon that confuses several people. This paper offers a variety of perspectives and definitions, as well as the possibilities of putting it in practice in Binh Dinh. Particularly, it presents efforts and reveals the possibilities that scientific tourism opens for Binh Dinh. The paper concludes with suggestions for a number of policy implications to promote the development of scientific tourism that will contribute to attracting more visitors to this area in the near future.

**Keywords:** Binh Dinh province; destination; scientific elements; scientific tourism

---

### **1. Introduction**

In recent years, tourism represents one of the most important and dynamic areas in the world economy. According to Surugiu (2009), tourism has an influence on the rate of growth and development, the volume of foreign exchange flows, infrastructure development, management techniques and new training experience as well as other areas of the economy, contributing positively to the economic and social development of a country. Tourism is a growing industry in not only developed but also developing and underdeveloped countries (Tasci and Knutson, 2004). According to the statistics of the United Nations World Tourism Organization – UNWTO (2017), in 2016, international tourists reached 1.235 billion visitors, rising 3.9% in comparison with 2015 and it is forecasted to continue to grow at the rate of 3.3% to reach 1.8 billion visitors by 2030. This year, it is estimated that tourism and travel contributed about 9.8% of GDP and accounted for approximately 9% of all jobs around the world. In the next ten years, the industry is expected to grow at an average annual rate of 4.5%, and may contribute about 10% of global GDP. It is the potential benefits travelers may bring to the destination that trigger a high competition in attracting tourists among regions, countries, or even among the local destinations of the same country.

As a coastal province beautiful in nature and rich in culture and history in the South Central Coast of Vietnam, Binh Dinh is a destination that has all basic tourist resources and advantages in comparison with neighboring provinces to organize almost all types of tourism on a large scale which can create great attraction for domestic and international tourists. However, the tourism industry has not really promoted this advantage, which can be seen in some main aspects such as the relatively low number of tourists coming to Binh Dinh, the short length of stay, the low expenditure of visitors, etc. Compared with some areas in the South Central Coast, Binh Dinh tourism is still modest. During the ten-year period from 2007 to 2016, Binh Dinh always positions around the fifth over eight provinces in the region in terms

---

\* Corresponding author. Tel.: 01694751359.  
E-mail address: dangthanhloan@fbm.edu.vn

of attracting both international and internal tourists.

The similarity in natural and cultural characteristics with other provinces in the region such as Da Nang, Quang Ngai, Phu Yen, Khanh Hoa, etc. is one of the causes leading to an overlap in creating tourism product. If each locality in the region does not identify its comparative advantages to build and develop unique tourism products, the duplication of products among localities in the region will result in limitations in the attractiveness of that locality. According to Pham Trung Luong (2015), the attractiveness of a tourist destination depends on many factors, among which tourism product is the most dominant. The attractiveness of a destination is often based on the distinctiveness of the tourism products relative to other destinations, environmental conditions, accessibility to destinations and images, information about the destination. Tourism product is the key to attracting tourists to a specific destination (Benur and Bramwell, 2015). However, at present, the types of tourism in Binh Dinh in particular and Vietnam in general lacks in special characteristics to attract tourists. The biggest problem is the duplication of travel products, mainly based on the availability of the localities without paying attention to meeting the needs of tourists as well as creating unique tourism products. Therefore, developing of typical tourism products will contribute to differentiating and enhancing the competitiveness of local, regional, and national tourism destinations.

“Wisdom is the greatest good, even if is useless in practical life” (Aristotle, 1988, p. 14). In recent years, the role of interdisciplinary science at the global level is being considered more and more important. In fact, tourism is a great platform for the creation of interdisciplinary sciences. Being one of the most attractive variants of cultural tourism, scientific tourism is one of the few forms of knowledge that unite relaxation and enjoyment with a broader vision of intellect. Scientific tourism is described as a form of tourism that creates and shares knowledge acquired. In the world, the close linkage of research programs with tourism and tourism capacity seems to produce positive results. There are many successful scientific tourism development projects in the world such as the Goa science center in Miramar, India; the Byurakan astrophysical observatory in Armenia; Patagonia scientific tourism which cradled between Pacific and Atlantic oceans, etc. Scientific tourism is directly related to archeological, museum, ethnographic, and astronomical tourism. In particular, humans have a great curiosity about the universe, stars and other celestial bodies; therefore, astronomical tourism is the youngest but most popular type of tourism. This paper analyzes how scientific tourism promotes local research and tourism development starting with the initiation of the International Center for Science and Education (ICISE) in Binh Dinh.

## 2. Theoretical review of scientific tourism

### Definition of scientific tourism

Scientific tourism is not a new form of tourism. Several scholars show interest in defining this term. The term “Scientific Tourism” might mean something quite different for a person who works in the area of tourism and for a normal traveler. Even tourism professionals have different opinions about this field of tourism. To understand the meaning of Scientific Tourism, attention should be paid to the basic nature of the terms “tourism” and “science” based on definitions from various sources.

**Table 1. Basic principles of scientific tourism**

<b>SCIENCE</b>	<ul style="list-style-type: none"> <li>- <b>Objectives:</b> To find an explanation about a certain phenomena correctly</li> <li>- <b>Requirements:</b> Logic, Systematic, Methodic, Empirically proven</li> </ul>
<b>TOURISM</b>	
<ul style="list-style-type: none"> <li>- <b>Objectives:</b> Aims at refreshing or entertainment and enjoying the existing tourism attractions</li> <li>- <b>Requirements:</b> <ul style="list-style-type: none"> <li>+ A travel from a certain area to other areas outside of daily routines both residence and workplace</li> <li>+ Temporary</li> </ul> </li> </ul>	<ul style="list-style-type: none"> <li>- <b>Objectives of Scientific Tourism</b> Seeking refreshment/entertainment of a journey undertaken by doing an activity or visiting the existing tourism object to get an explanation of certain phenomenon properly and broaden the knowledge for travelers.</li> <li>- <b>Requirements of Scientific Tourism</b> Travel from one place to another place outside the daily routine (both residence and work) for temporary, to do activities or go to the tourism object that presents a logical knowledge with certain methods, systematic and empirically provable.</li> </ul>

Source: Rosyidie et al. (2012, p.133)

The term “scientific tourism” first appeared in tourism literature in the late 1980s in the work “Tropical Science and Tourism” (Laarman and Perdue, 1989). In this work, it was described as a work of explorers in countries without proper technical equipment. According to Rosyidie et al. (2012), scientific tourism is a form of tourism that is interested in science or has the need for learning and scientific research. This is a type of tourism that includes scientific elements during the travel, such as journeys to observe or study the diversity of flora and fauna in the forest, to observe the behavior of animal or marine life, to observe stars and space in the observatory, to visit science and technology

galleries, museums, laboratories, universities, geological tours or trips to the volcano area, etc. According to West (2008), scientific tourism is a special form of tourism related to scientific practice that also benefits for tourism. In addition, this term refers to the knowledge tourism of the majority of young people who acquire knowledge and skills without the need for large financial expenses (Ilyina and Mieczkowski, 1992). Scientific tourists use conventional tourism infrastructure (hotels, catering facilities, transport, cultural performances, relaxation centers) in addition to the use of the latest audiovisual technology for workshops and conferences.

Scientific tourism is a type of tourism that promotes a touristic and scientific culture that allows the exploration, sharing and evaluation of the origins, customs and knowledge of a field in a creative way (Fazconsultora, 2012). At first, scientific tourism was considered by some as the journeys of researchers, academics and higher-level students to undertake research. Later, this narrow definition was extended to encompass parish tourism programs in exploration, excavation and other scientific activities. To date, scientific tourism aims to approach a new tourist profile that is more specific and interested in any scientific field to the territory. In this sense, it is a segment of particular interest tourism where products are combined with the development of scientific knowledge that creates opportunities for research support, as well as the transfer of knowledge to non-specialized public.

#### **Characteristics of scientific tourism**

According to Rosyidie et al. (2012), characteristics of scientific tourism would be much simpler if it is considered from the tourism components, namely:

- The purpose of travel is to entertain, relax, and expand visitors' knowledge and experience through visiting tourist attractions, participating in activities or receiving accurate explanations of current events. The final result of scientific tourism is refreshment, insight and experience as well as knowledge increase for tourists.

- Tourism activities are characterized by scientific activities in order to enhance the specific knowledge for tourists during the tour and are often packaged and supported in a variety of explanations, understanding or learning about a particular science. However, certain tourism activities may be classified as scientific tourism if the attractions or objects have scientific contents or scientific significance although they are not packaged into a tourism package with various scientific activities, e.g. a visit to museums, monuments or historic buildings, to forests, to areas with specific geological/geographical features (such as limestone mountains, caves, sand dunes, estuaries, volcanoes, etc.).

- Most scientific tourists are groups of children and youth (students of elementary schools, high schools, and undergraduate students) as well as certain professionals either individually or in groups. The basis of scientific tourism is meeting the educational, cultural and relaxing demands of groups of people who are concerned about the same things.

### **3. Current status of tourism development in Binh Dinh Province**

#### **3.1. Potential for tourism development in Binh Dinh province**

##### **3.1.1. About natural tourism resources**

With a 134-kilometer long coastline bordering nearly half of the districts, Binh Dinh is blessed with many beautiful sights and beaches. Most of the beaches which are relatively flat with white sand, clear blue water, sunshine and beautiful scenery are quite pristine with potentials for development of marine tourism such as Quy Nhon, Ghenh Rang, Quy Hoa, Bai Dai, Phuong Mai Peninsula, Thi Nai Lagoon, Cu Lao Xanh, Hai Giang, Nhon Ly, Eo Gio, Phu Hau, Trung Luong, Vinh Hoi, Tan Thanh, Mui Rong - Tan Phung, Lo Dieu, Hoai Huong, Tam Quan Bac, etc. These are considered as the most important and valuable natural resources that can contribute to promoting Binh Dinh tourism to become a key province in tourism in the near future. The most beautiful beaches are located in Quy Nhon and adjacent areas, which is very convenient for planning and investing in complex clusters and routes.

In addition, Binh Dinh also has a variety of mountainous terrains, rivers, lakes and nearly 150,000 hectares of natural forests, creating many unique landmarks such as Ham Ho, Nui Mot Lake, Hoi Van hot mineral spring. Binh Dinh province also has a relatively rich and diverse fauna and flora system, which is an indispensable resource for the development of some types of tourism, especially eco-tourism.

##### **3.1.2. About human resources**

Being a province with a long history and culture, Binh Dinh has an invaluable treasure, both tangible and intangible culture considered as the biggest advantage of Binh Dinh tourism compared with other provinces in the region. Binh Dinh is a land of the royal dynasty of Champa - a feudal dynasty which has reached brilliant achievements of culture, art, religion, etc. During nearly 500 years of existence, these dynasties has left many priceless cultural heritages, especially Do Ban and 13 Cham towers. Cham tower system in Binh Dinh is considered to be quite intact, magnificent and beautiful with unique styles.

Binh Dinh is proud to be the cradle of the Tay Son peasants' movement, the homeland of hero Quang Trung-Nguyen Hue. Currently, the Tay Son monuments has been gradually restored, embellished to be more dignified, bigger to become major tourist attractions of the province. Being a land of "spiritual land", Binh Dinh is also the birthplace of

many cultural and revolutionary people of the nation. Historical relics associated with religion such as Temple Thap Thap; Linh Phong Pagoda; Long Khanh Pagoda, etc. establish an important basis for the development of spiritual tourism. In terms of intangible culture, Binh Dinh is known as the “land of martial arts”, the cradle of Tuong and Bai Choi arts, many special festivals, traditional villages and a unique culinary background. Binh Dinh people are hospitable and friendly.

### 3.1.3. About the ability to welcome tourists to Binh Dinh province

In terms of travel organizations, there are over 30 travel agencies in the province, including 6 international travel agencies. In general, Binh Dinh travel agencies gradually meet the needs of tourists inside and outside the province.

In terms of accommodation, by the end of 2016, there are more than 149 tourist accommodation establishments in the province with a total of 3,905 rooms. Eight of these establishments are from 3-5 stars, with 1,270 rooms (accounting for 32.5% of the total). The remaining 141 establishments are 1-2 star hotels and other types of accommodation such as guest houses with 2,813 rooms (accounting for 67.5%). Most of the 3-5 star hotels are located along the coast while under 3-star establishments are scattered throughout the city. In parallel with the high increase in quantity, the establishments also constantly invest and improve the quality of services to exploit MICE tourism, conferences and seminars to meet the increasing demand of tourists.

In terms of human resources for tourism, within the last five years, tourism human resources have developed in both quantity and quality. However, by 2016, of the more than 4,500 direct workers in the tourism sector of the province, the number of trained workers is still low, skilled workers are short and weak, especially tour guides, interpreters, receptionists and business managers. Therefore, to cope up with the requirements of international economic integration and the requirements of industrialization and modernization of the country, Binh Dinh tourism workforces are gradually trained to improve their knowledge of professional skills and qualifications and foreign language in order to meet the development requirements of the industry in both quantity and quality.

In terms of infrastructure for tourism, Binh Dinh is a province with good transportation system by road, rail, waterway and airway. National Highway 1A stretches 118 kilometers through Binh Dinh, National Highway 1D with 20.7 kilometers, and National Highway 19 with 69.5 kilometers. Especially, National Highway 19 that connects Quy Nhon international seaport with provinces in the Northwest Highlands via Duc Co, Bo Y international border gates and the Vietnam-Laos-Cambodia border is one of the roads with highest quality in the horizontal axis transportation system in Central Vietnam, facilitating the East-West linkage, promoting economic exchanges and development cooperation with the outside. Located 30 kilometers north-west of Quy Nhon, Phu Cat Airport with a 45 meter-wide, 3,050 meter-long runway are being upgraded. The north-south railway crosses Binh Dinh with 148 kilometers including 11 stations, among which Dieu Tri station is a large station. Quy Nhon port is one of the deep water ports that can accommodate large cruise ships. Besides, the post and telecommunication network with all kinds of services can quickly meet the demand for information exchange.

## 3.2. Tourism product system

According to the report “Adjusting and supplementing the overall plan for tourism development in Binh Dinh province to 2020 with a vision to 2030”, Binh Dinh tourism products are increasingly diversified and improved. Most prominent are the products associated with seas and islands. The sea and island tourism product line mainly develops beach resorts, sea bathing and marine ecology (Ghenh Rang, Phong Dien, Trung Luong, Tan Thanh, Hon Kho, Cu Lao Xanh, etc). In addition, cultural tourism products such as visits to cultural and historical monuments, and places with ethnic identity are also marked by the highlights of the system of resources associated with the celebrity, with the history of national wars in the area and with the cultural identity of ethnic minorities, etc.

Tourism associated with meetings, incentives, conferencing and exhibitions (MICE) is also a product of great interest in Binh Dinh tourism industry and it has gradually made its own mark. Quy Nhon City has increasingly demonstrated as the right place to hold important events such as conferences, seminars, fairs and sports; Quang Trung Museum has become an increasingly popular tourist destination (Dong Da - Tay Son Festival, Binh Dinh traditional martial arts ...). Touring craft villages has been established in traditional craft villages such as Bau Da wine (An Nhon), Nhon Hau wood fine art, Tam Quan coconut mat, etc. associated with the viewing, understanding and purchasing souvenirs. In addition to product development, the system of accompanying services including providing eating and selling local products have contributed to the diversity of attractive travel programs.

## 3.3. Results of tourism business in Binh Dinh

Tourism activities of Binh Dinh have prospered in recent years. The number of tourists to Binh Dinh is increasing. Tourism continues to develop and some businesses continue to invest in upgrading infrastructure, improving the quality of service, promoting link with other provinces inside and outside the country. According to statistics from Binh Dinh Tourism Department, in 2016, Binh Dinh tourism received 3.2 million visitors, rising 23% compared with 2015,

including 2.94 million domestic passengers, rising 23% and 256,00 international visitors, rising 24%. Net tourism revenue reached 1,497 billion VND, rising 44% in comparison with 2015. However, compared to many other localities in the region, Binh Dinh is a province that has just started to develop tourism activities in recent years. Within the ten-year period from 2007 to 2016, Binh Dinh always positions around the fifth over eight provinces in the region in terms of attracting both international and internal tourists. There is a huge gap between potentials and reality of developing Binh Dinh tourism.

**Table 2. Criteria of tourists in Binh Dinh in the period 2013-2016**

Criteria	Calculation unit	2012	2013	2014	2015	2016
<b>Total guests</b>	Passenger	1,463,000	1,696,300	2,084,400	2,602,000	3,200,000
- International tourists	Passenger	120,700	138,860	171,500	205,950	265,000
- Domestic tourists	Passenger	1,342,300	1,557,440	1,912,900	2,396,050	2,935,000
<b>Average stay length</b>	Day/Passenger	1.8	1.9	2.0	2.1	2.5
<b>Total revenue from tourism</b>	billion VND	475	603	787	1,037	1,497

Source: Binh Dinh Tourism Department

Tourism in Binh Dinh is experiencing rapid growth, especially in the last ten years. The number of tourists to Binh Dinh is dominated by domestic tourists, especially those from the Central Highlands, Hanoi and Ho Chi Minh City. Although the number of tourists has increased over the years, it is still low compared to the tourism potentials of the province. The increase of tourism revenue is not only in Binh Dinh province, but also in all provinces in the South Central Coast is corresponding to the increasing tendency in the number of domestic and international tourists over the years. It has been commented that Binh Dinh does not have services to keep tourists, and tourist activities in Binh Dinh are mainly spontaneous by some individuals, or by the individual tourism companies. In Binh Dinh, there are some scientific tourism destinations, but the number of visitors is relatively small. Some factors leading to the modest number of tourists to Binh Dinh are the low interest of tourists on scientific tourism, less attractive tour, limited facilities and lack of promotion.

#### 4. Potentials for developing scientific tourism model in ICISE

The romantic, beautiful and peaceful 130-hectare Quy Hoa located in Quy Nhon city facing the sea with three mountain sides has been planned by Binh Dinh to become scientific urban to be a meeting point for national and international scientists and at the same time the place attracting tourists. ICISE is a cross-river building designed to provide a space for conferences, research and relaxation to benefit the scientific community. In harmony with nature, the building has no high-rise buildings but a large 300-seat hall, a small 100-seat hall, a four-star hotel, restaurants, cafes, bungalows, cogitum, spa, freshwater swimming pool, stream bridge, walks through the woods, etc. ICISE is trying to create unique products to attract tourists associated with the research journey exploring scientific space. This center has attracted thousands of leading scientists in the world to Binh Dinh to attend conferences and seminars in combination with tourism.

Right next to ICISE is an equally impressive work, which is a scientific space complex of 3.8 hectares. The scientific space complex is the place where science is present in a practical way that visitors can touch upon the scientific achievements. This complex consists of three divisions namely space model, science museum and astronomical observatory. Particularly:

+ The space model includes projection and observing rooms with the latest projection technology to help viewers explore the universe, explain issues related to lively astronomical visualization. The space model will include a cosmic projection room and an exhibition area developed based on the technology of several Europe's leading cosmological models. The 300-square meter, 80-seat space screening area is equipped with a 12-meter diameter artificial arch and a 360-degree-view projection screen to simulate the sky, the motion of planets and constellations. The 500-square-meter space model area consists of 4 rooms: the Solar System Exploration Room, the Granology Room, the Space Discovery Room and the Earth Exploration Room.

+ The Science Museum is the place for demonstrations and exhibitions of scientific models and experiments in the fields of mathematics, physics, chemistry, biology and astronomy.

+ The Astronomical Observatories is a place where visitors can observe distant stars in the universe through the telescope.

ICISE and the Scientific Space Complex are expected to form an urban area for science and to be an ideal place for students and researchers to thoroughly explore and see firsthand the latest scientific models in the world. Turning this place into a scientific tourism address as some countries have done will surely attract more visitors and scientists. To create a unique tourism product for Binh Dinh in the future, a number of scientific tourism activities can be implemented such as:

- Organize exhibitions and galleries to study the basic principles of physics. Variable artifacts can be adjusted to meet the curiosity of young people.
- Organize periodical activities such as the Creative Science Competition, the Astronomical Olympiad, etc. to raise the interest and talents of students.
- Organize celebrations, exhibitions, and workshops on breakthroughs in the field through collaboration with organizations in the scientific community.

## 5. Some solutions to promote the development of scientific tourism

Scientific tourism is a new type of tourism with the purpose of spreading knowledge about research to the public. It is based on the collaboration between scientists and tourism businessmen. This is a kind of collaboration where scientific work is associated with the experience of travel organizers to address the needs of travelers. Normally, a scientist knows how to guide research and a tourism businessman knows how to satisfy the needs of visitors, but few can do both well. Scientists must understand the needs and expectations of visitors for their support. Tourism businessmen not only focus on visitor needs, but also address the specific needs of scientific researchers and the importance of scientific research. Therefore, in order to develop scientific a tourism product, it is necessary to cover three phases: (1) exploring future trends in scientific research; (2) developing research programs and establishing the needs related to human resources and logistics involved; (3) commercialising the product. Those who are concern may include international research institutes, universities, national and international researchers and students, organizations involved and responsible for management, business development, cultural conservation and heritage preservation, environmental protection and tourism promotion, etc. Regardless of the potential implications of research programs, most stakeholders are interested in sharing scientific knowledge.

Besides ICISE acting as a meeting point for researchers, universities, non-governmental organizations, schools and local individuals who are interested in sharing their knowledge by publishing on-going research, pilot projects, and latest scientific discoveries, the scientific space complex is the place where people can purchase tourism services. Once performing its attractiveness, scientific space complex will become a significant destination that cannot be missed in the journey of tourists to Binh Dinh. In order to create an appeals to visitors, it is necessary to:

- Develop, empower and explore a variety of potential scientific tourism objects or attraction.
- Explore various investment opportunities for the development of scientific tourism and provide opportunities for investors.
- Invest more interactive display devices to encourage visitors to touch, learn and enjoy.
- Display artifacts in a systematic and appealing way to attract viewers (perhaps each area should exhibit a cross-cutting theme from the field of basic science to the theorems taught in schools and to the latest technologies).
- Edit scientific knowledge maps and booklets for travelers to improve the effectiveness of collaboration between researchers and non-professionals.
- Train tourist guides to explain and guide visitors to explore science.
- Build up a cooperation among members of scientific tourism objects and group potential markets such as schools, universities and educational institutions.
- Socializing and promoting scientific tourism through various means or media.
- Try to erase prejudice that science museum is simply a display and demonstration of knowledge; instead, it is a place where visitors learn, experience and visualize the difficult-to-understand scientific knowledge.
- Build up positive image in the community about opportunities to improve knowledge and understanding through tourism.

## 6. Conclusions

Tourism sector is growing rapidly, not only in developed countries but also in developing countries, including Vietnam. Tourism activity has become a part of human lifestyle. The number of both international and domestic tourists are also experiencing a rapid growth. There is a diversity in types of tourism, including scientific tourism. Scientific tourism is an interesting example of combining the characteristics of some types of tourism. The activities undertaken should reflect an understanding process or scientific learning while traveling. Tourism attractions should have meanings and explanations about various scientific knowledge.

As an international scientific tourism destination, ICISE will bring significant benefits for the local economy, especially for tourism companies in the region. Strategies and programs for development of sustainable scientific tourism in Binh Dinh needs to involve other related sectors. Those strategies include promotion, improvement of package tours, cooperation with educational institutions, improvement of the quantity and quality of facilities, and improvement of the quality of human and management resources, and other important supporting programs.

Although the marketing and commercialization of scientific tourism products are relatively new, tourism development is also based on the assessment of resources suitable for tourists. Adding value to tourism products depends on the capacity of local stakeholders to take advantage of available resources. Binh Dinh has become a place of

cooperation among stakeholders, but it is necessary to carry out institutionalized coordination for the system effectiveness. Thousands of scientists from many countries in the world, including many Nobel laureates and prestigious scientists are reliable propagators to promote the image of Binh Dinh to the world.

## References

- [1] Aristotle (1988). *Zachęta do filozofii Exhortation to Philosophy*. Warszawa: PWN.
- [2] Benur, A. M., Bramwell, B., (2015). Tourism product development and product diversification in destinations. *Tourism Management*, 50, 213-224.
- [3] [Http://fazconsultora.com/faz/en/observer-turismo-cientifico/](http://fazconsultora.com/faz/en/observer-turismo-cientifico/)
- [4] [Http://sodulich.binhdinh.gov.vn/](http://sodulich.binhdinh.gov.vn/)
- [5] Ilyina L., Mieczkowski, Z., (1992). Developing tourism in scientific Russia. *Tourism Management*, 13(3), 327-331
- [6] Laarman, J. G., and R. R. Perdue. 1989. Tropical science and tourism: The case of OTS in Costa Rica. *Annals of Tourism Management*, 10, 29–38.
- [7] Molokáčová, L., Molokáč. Š., (2011), Scientific tourism – Tourism in science or science in tourism. *Acta Geoturistica*, 1(2), 41-45.
- [8] Phạm Trung Lương, (2015). Xây dựng sản phẩm du lịch đặc thù, đẩy mạnh phát triển du lịch quận Cẩm Lệ. *Tạp chí Phát triển Kinh tế - Xã hội Đà Nẵng*, số 67, trang 10-13.
- [9] Rosyidie, A., Leksono, R. B., Adriani. Y., (2012). Scientific tourism potential in Bandung city. *ASEAN Journal on Hospitality and Tourism*, 11(2), 129-149.
- [10] Surugiu, C., 2009. The economic impact of tourism. An input-output analysis. *Romanian Journal of Economics*, 29(2): 142-161.
- [11] Tasci, A. D. A., Knutson, B. J., (2004). An argument for providing authenticity and familiarity in tourism destinations. *Journal of Hospitality and Leisure Marketing*. 17(1), 73-82.
- [12] Tỉnh Ủy Bình Định, (2016). Điều chỉnh, bổ sung Quy hoạch tổng thể phát triển du lịch tỉnh Bình Định đến năm 2020, tầm nhìn đến năm 2030.
- [13] UNWTO, (2017). UNWTO tourism highlights. 2017 edition. Available at <<http://www.e-unwto.org/doi/pdf/10.18111/9789284419029>>.
- [14] West, P., (2008). Tourism as science and science as tourism *Environment, society, self, and other in Papua New Guinea*. *Current Anthropology*, 49(4), 597 - 626.



International Conference For Young Researchers In Economics And Business, ICYREB 2017, October 30<sup>th</sup> 2017  
Da Nang, Vietnam

# Factors Influencing the Usage of Balanced Scorecard for Performance Measurement in Enterprises in Viet Nam

Hoang Van Tuong<sup>\*</sup>, Dinh Hoai Nam<sup>†</sup>, Nguy Thu Hien<sup>‡</sup>

<sup>1</sup>Academy of Finance, No. 8 Phan Huy Chu, Ha Noi, Viet Nam

<sup>2</sup>Institute of Financial Training, No.4, Hang Chuoi, Ha Noi, Viet Nam

<sup>3</sup>Academy of Finance, No. 8 Phan Huy Chu, Ha Noi, Viet Nam

## ABSTRACT

The Fourth Industrial Revolution will create great challenges but also opportunities for Viet Nam to take off. In order to survive and grow, enterprises doing business in Viet Nam need to adopt advanced management methods. Balanced Scorecard (BSC) is a highly effective method for performance measurement and strategic management in enterprises. There are still limited number of studies about the factors that influence the usage of BSC for performance measurement in enterprises in Viet Nam. The present study was undertaken to test the hypothesis of the relationship between the contingency variables and the usage of BSC for performance measurement. The study was designed as an empirical investigation by conducting 217 questionnaires given to the enterprises in Viet Nam and using factor analysis, ordinary least square (OLS) regression analysis. The results of this study showed that the business strategy, perceived environmental uncertainty, intensity of competition, total quality management have significant positive impact on the usage of BSC while the organizational structure have no impact.

**Keywords:** Balanced scorecard; contingency variables; performance measurement, enterprise; Viet Nam

## 1. Introduction

The fourth industrial revolution is blurring the gap between the real world and the virtual world through advanced technologies and innovation. This revolution brought about opportunities and huge challenges. In order to survive and grow, enterprises doing business in Viet Nam need to adopt advanced management methods. BSC is probably one of the most important recent accounting innovations. It is supposed to enhance organizational performance by allowing top managers to manage their enterprises' process resulting in an improved competitive market position and company performance. The BSC was first introduced by Kaplan and Norton in 1992 as a performance measurement system designed to provide managers with a way of translating strategy into a set of financial and non-financial measures covering different domains of the organization. Despite the increasing emphasis placed on BSC, many recent papers in management accounting journals have asserted the need for undertaking more studies on both the use and importance of BSC (Ittner et al, 2003; Eric Tanyi, 2011). In addition, a contingency theory framework has been widely used in management accounting research but this stream of research has generally investigated the impact of few contingent variables relating to BSC. Thus, several researchers (e.g. Francis and Minchington, 2000; Ittner and Larcker, 2001; Speckbacher et al., 2003; Maltz et al., 2003) suggest the need to undertake more research to examine the impact of several contingent variables on the design and use of BSC. These suggestions provided further insights for studying BSC.

In this study, we examined contingency factors influencing the usage of the BSC by using a survey data. The contingency factors we examined include business strategy, organizational structure, perceived environmental uncertainty, intensity of competition, total quality management. We tested our model and hypotheses by using a sample

\* Corresponding author. Tel.: +84982951768.

E-mail address: tuonghoangvanhvtc@gmail.com

of 217 enterprises in Viet Nam.

Consistent with our predictions, we found that the usage of BSC was significantly related to business strategy, perceived environmental uncertainty, intensity of competition, total quality management. However, we do not find the decision to adopt the BSC to be related to organizational structure.

Our study contributes to the literature in two ways. First, this study provides evidence on the contingency factors influencing the usage of the BSC for performance measurement in enterprises in Viet Nam. Second, most of the BSC studies have been conducted outside Viet Nam. With respect to differences in the results across countries, it caught my interest to compare whether the results of this study, particularly the BSC implementation stage, are similar to the results reported in the previous researches.

The remainder of the paper is organized as follows. First, we discussed the theoretical background of our study focusing on the literature of BSC and the contingency variables salient to BSC adoption and offer our research hypotheses. Second, we described the research method approach. Third, we present our results that test our predictions. Finally, we offer a discussion of the research results before concluding.

## 2. Literature review

### 2.1. Balanced scorecard

In response to the need to incorporate key non-financial performance measures and integrate financial and non-financial measures, Kaplan and Norton (1992) devised the BSC as a set of performance measures to provide managers with a comprehensive view of the organization, and a reliable feedback for management control purposes and performance evaluation. This approach consists of two types of performance measures. The first is financial measures to describe the past actions. The second is non-financial measures on customer satisfaction, internal business processes, and innovation and improvement activities as drivers of future financial performance. Kaplan and Norton (1996) indicated that the measures of this approach represent a balance between external measures for shareholders and customers, and internal measures for critical business processes, innovation and learning and growth. These measures are balanced between the outcome measures (i.e. the results from past efforts) and the measures that drive future performance.

According to Kaplan and Norton (1992), the BSC approach consists of the following performance perspectives:

**Customer perspective:** The measures relating to this perspective require managers to translate their general mission statement on customer and market segments into specific measures that reflect the factors that really matter to the customers. Managers should develop performance measures in order to create satisfied and loyal customers in the targeted segments. Customer's concerns relate to time, quality, service and cost. Therefore, the customer perspective includes different core objectives and measures that relate to the organization's strategy. Examples include goals and measures relating to increasing market share, customer retention, and customer satisfaction.

**Internal business process/operational perspective:** The measures within this perspective are related to the critical internal processes for which the organization must excel to implement strategy. The identified processes should stem from the requirements needed to achieve the organization's customer perspective. Kaplan and Norton identified several generic internal processes, such as operation and post-service sales processes, and stress the need to develop appropriate performance measures relating to these processes such as measures related to time, quality and cost.

**Learning and growth/innovation perspective:** These types of measures are concerned with building continuous improvement in relation to products and processes, and to also create long-term growth. Kaplan and Norton stress that organizations can improve and innovate to achieve the objectives of the scorecard through the ability to launch new products, improve operating efficiencies and create more value for customers.

**Financial perspective:** Measuring within this perspective is based on financial metrics such as return on investment, and residual income. Kaplan and Norton argued that by incorporating non-financial performance measures in the scorecard, improved financial measures should follow. Moreover, this perspective provides feedback as to whether improved performance in the non-financial perspectives is translated into monetary terms in the financial perspective box.

The BSC enables financial and nonfinancial measures to be part of the information system for employees at all levels of the organization. Front-line employees can understand the financial consequences from their decisions and actions, and senior executives can understand the drivers of long-term financial success. The BSC represents a translation of a business unit's mission and strategy into tangible objectives and measures. The four perspectives of the scorecard permit a balance (1) between short- and long-term objectives, (2) between external measures- for shareholders and customers- and internal measures of critical business processes, innovation, and learning and growth, (3) between outcomes desired and the performance drivers of those outcomes, and (4) between hard objective measures and softer, more-subjective measures.

## 2.2. Contingency theory and hypothesis development

A contingency theory is an [organizational theory](#) that claims that there is no best way to organize a corporation, to lead a company, or to make decisions. Instead, the optimal course of action is contingent (dependent) upon the internal and external situation (Donaldson, 2001). A contingent leader effectively applies their own style of leadership to the right situation. Contingency research has mainly sought to explain how management accounting control systems (such as budget use, budget evaluation styles, and performance appraisal system) are influenced by different contingent variables. A major strand of management accounting research has been the usage of contingency theory to the study of BSC (Chenhall and Morris, 1986; Majdy, 2003; Otley et al. 1998; Otley, 2001).

Drawing from Majdy's (2003) summary and previous research in the area, we examine the importance of contingency variables in explaining the decision for enterprises usage the BSC. Specifically, we examine: business strategy, organizational structure, perceived environmental uncertainty, intensity of competition, total quality management.

### Business strategy

The business strategy is a search for a favorable competitive position in an industry (Porter, 1980). There are few empirical studies which supports the relationship between business strategy and the use of several management accounting practices such as activity-based costing (ABC) systems and BSC approach (Anderson and Lanen, 1999; Olson and Slater, 2002). Hoque et al. (2001) suggested that there is a need for further investigations of how a set of performance measurements, rather than single measurement, could be useful to organizations operating in varied industries with various competitive strategies. However, past empirical studies (e.g. Olson and Slater, 2002; Sohn et al., 2003) have investigated the relationship between business strategy and the usage of BSC perspectives. These studies have shown that prospector companies follow a differentiation orientation place greater emphasis on the usage of non-financial perspectives of the BSC. Accordingly, it can be expected that companies pursuing differentiation strategy are more likely to use the BSC approach than companies that pursuing low cost strategy. Thus, it can be hypothesised that:

Hypothesis 1 (H1): Differentiation strategy has a positive impact on the extent of BSC usage.

### Organizational structure

The term organizational structure is considered to be an important internal aspect that influences the design of management accounting system. Structure is defined as the way in which an organization is differentiated and integrated (Lawrence and Lorsch, 1967).

Several researchers argue that organizational structure may influence the adoption and implementation of innovation (Gosselin, 1997, Mooraj et al., 1999). In this context, Braam and Nijssen (2004) argue that the chance of usage of BSC is more likely in high centralized organizations. Thus, it can be hypothesized that:

Hypothesis 2 (H2): Centralised organization has a positive impact on the extent of BSC usage.

### Perceived environmental uncertainty

The environment comprises all the external factors to the organization. Perceived environmental uncertainty is one of the crucial contingent variables that have been widely used in management accounting information characteristic research. There has been much empirical evidence which has indicated that the increase level of perceived environmental uncertainty leads to a greater need for management accounting information in terms of non-financial performance measurements (Cauvin and Bescos, 2002; Chenhall, 2003). Companies should predict the conditions that will exist during the coming years, and this can be done more accurately under stable environmental conditions than dynamic and changing conditions (Govindarajan, 1984). Based on the results of previous empirical studies it can be hypothesised that:

Hypothesis 3 (H3): Perceived environmental uncertainty has a positive impact on the extent of BSC usage.

### Intensity of competition

The integration or balance in the performance measurement system is necessary for the organization's long-term success in today's competitive environment (Euske et al., 1993). The literature on the BSC approach has revealed that the level of competition is the most important factor that may affect the usage of BSC approach (Hoque and James, 2000; Malmi, 2001). Recently, Maiga and Jacobs (2003) argued that BSC are implemented in response to the competitive environment. Empirically, several studies (e.g. Hoque et al., 2001; Banker et al., 2001) found that companies implementing the BSC approach are facing high levels of market competition. Based on the findings of previous empirical studies, it can be expected that companies facing greater competitive pressures are more likely to use the BSC approach. Thus, it can be hypothesised that:

Hypothesis 4 (H4): Intensity of competition has a positive impact on the extent of BSC usage.

### Total quality management

In today's global competitive markets, the demand of customers is increasing, as they require improved quality of products and services. A continuous improvement in organization activities with a focus on the customer is the main aspect of quality and its management. An important issue related to quality is total quality management (TQM), which is considered to be one of the most important components of advanced management practices. The association between TQM and non-financial performance measures has been reported in several studies. McAdam and Bannister (2001) argued that business performance is linked to TQM implementation. In their case study they concluded that

organizations applying TQM should incorporate financial and non-financial performance measures. Empirically, Malmi (2001) reported in his interviews that one of the important initiatives to encourage the adoption of the BSC is the use of total quality management. Recently, Hoque (2003) recommend using the BSC approach to support the implementation of total quality management initiatives. Based on the above discussion, it can be expected that companies pursuing total quality management are more likely to use the BSC approach. Thus, it can be hypothesised that:

Hypothesis 5 (H5): The extent of the use of total quality management has a positive impact on the extent of BSC usage.

Our research model is presented in Figure 1 (see the Appendix). The figure shows the relationship between two parts of the model. The first part is concerned with seven contingency variables. The second part is concerned with the extent of usage of balanced scorecard.

### 3. Research methodology

Following the same track of prior studies, current study has also adopted a quantitative research approach and questionnaire survey design is chosen for this study.

**Sample.** The target population for this study is all enterprises in Viet Nam irrespective of type (manufacturing, services), nature (textile, automobile cement etc.), ownership (public, private etc.), and location. Sample enterprises are selected through purposive sampling technique. We drew a sample of 217 enterprises. In each organization, who can give answer to questions about the usage of BSC and that individual may be CEO, member of board of directors, head of any major department and staffs.

**Survey Instrument and Data Collection.** Data for this study were collected using survey questionnaire. The questions in the survey are taken from previous researchers with some slight modifications (see the Appendix). We first developed all scales and questions in English and then translated in to Vietnamese. In order to ensure the purpose of accuracy and correct understanding, two Vietnamese experts in English checked the translations. Most of the questions used five point Likert scale which is equivalent to “1 = strongly disagree”, “2 = disagree”, “3 = neutral”, “4 = agree”, and “5 = strongly agree”. Survey questions were created and published on the internet to collect response for the study. Google (a popular survey tool) was used to create the question. The online survey was open for two months from August 1, 2016 to September 30, 2016. The final sample consisted of 217 questionnaires with valid data.

**Data analysis.** The data collected for this study were analyzed using a SPSS 20.0 software. The responses from the field were uploaded from Google usage into excel spreadsheet. In excel, the data was further trimmed and codified to allow easy access to the SPSS 20.0 software package. Afterwards, the dependent and the independent variables were each assign a code that will aid the interpretation of the output from the SPSS system. In the SPSS software program, coefficient alpha, factor and item-to-total correlation analysis was used to structure and classify the variables. The different questions were asked pertaining to each of the variables was collapsed into a single variable. Then, OLS regression method was used to analyze the data.

## 4. Result

### 4.1. Descriptive Data of User Characteristics

Table 2 shows the relative description of users' characteristics. The specific user characteristics are analyzed as presented below (see the Appendix).

The respondents were asked to indicate which perspectives are used in performance measurement. Table 3 shows the type of perspectives used by enterprises (see the Appendix).

### 4.2. Reliability analysis

Reliability is the overall consistency of a measure in statistics & psychometrics. We conducted a reliability analysis with SPSS 20.0 software to test the reliability of all measures. Internal consistency reliability can help to assess the consistency of results across items within a test.

Corrected item-total correlation provides “an indication of the degree to which each item correlates with the total score” (Watson, 2001). The value is defined as Cronbach's coefficient alpha that is between 0 and 1 in most cases. 0 indicates no internal consistency and reliability, while 1 indicates strong internal consistency and reliability (Bryman and Bell, 2007). A result of less than .400, indicates that the item measures something different from the scale as a whole. If the scale Cronbach alpha for an item is less than .600, we may need to consider removing it. A value over .700 is validates the internal consistency and reliability of the scale (Pallant, 2001). The reliability analysis results are summarized in Table 4 (See the Appendix).

From the Cronbach's coefficient alpha result, all values exceed .700, showing efficient internal reliability for all measurement items in our survey. The main alpha values of independent variables (BS, OS, PEU, IC, TQM) and dependent variables are all over .700, proving very good internal consistency and reliability for the scales in our survey.

However, The Corrected Item-total Correlation for item PEU1, PEU2, PEU3, IC6, IC7 were .240, .280, .291, .396, .293 respectively, indicating unacceptable level of reliability. So that, it was decided to exclude them from the analysis before factor analysis.

### 4.3. Factor analysis

In factor analysis, all items measuring same construct loaded on a single factor with high factor loading ranging from .600 to .900 which establishes convergent validity or convergence of all items to their respective theoretical defined constructs (Hair et al., 2014). Similarly, not a single case is there where cross factor loading is greater than .500 and all items loaded on their respective factors and it indicates the existence of discriminant validity (Tho, 2013).

In this study, two factors analyses were conducted using the principal extraction method and varimax rotation of 3 items of the dependent variables group and 24 items of the independent variables group. The Kaiser-Meyer-Olkin measure of sampling adequacy was .709 for the group of dependent variables and .871 for the group of independent variables. This value was significant. Similarly, Bartlett's test of Sphericity was significant ( $p < .000$ ), indicating sufficient correlation between the variables. Hence, KMO and Bartlett's test proved the suitability of current data for factor analyses. The high values of item-to-total correlation are also supporting the convergence validity and internal consistency of constructs. The factors analysis results are summarized in Table 4 (See the Appendix).

### 4.4. Factors influencing the usage of BSC and hypotheses testing

In order to examine the relationship between the usage of BSC and all independent factors, correlation and regression analyses are used. The Table 5 (see the Appendix), illustrates that usage of BSC is significantly correlated and has positive relationship with business strategy (differentiation strategy) ( $r = .516, p < .01$ ), perceived environmental uncertainty ( $r = .630, p < .01$ ), intensity of competition ( $r = .666, p < .01$ ) and TQM ( $r = .414, p < .01$ ). The relationship of usage of BSC is significant and has negative relationship with organizational structure ( $r = -.216, p < .01$ ). The regression estimates help to determine the intensity of influencing each factors may offer. The adjusted  $R^2$  indicates that the regression model explains 58.8% of the variance in BSC usage.  $R^2$  is influenced by the number of independent variables relative to sample size (Hair et al., 2014). The high value of  $F = 62.613$  with  $p < .00$  approves the significance of the model i.e. these predictors have influence on usage of BSC.

Table 6 (see the Appendix) indicated the degree of relationship of predictors have with usage of BSC. The factor that had the strongest effect on usage of BSC was perceived environmental uncertainty ( $\beta = .322, p = .000$ ), these values support the hypothesis 3 (H3) that perceived environmental uncertainty has a positive impact on the extent of BSC usage. This positive effects of PEU dimensions are consistent with Chenhall and Morris (1986), Eric Tanyi (2011) empirical findings indicate that increasing levels of perceived environmental uncertainty lead to a greater need for management accounting information in terms of non-financial performance measurements. The results are also consistent with Chow et al. (1997), Majdy (2005) theoretical argument that the usage of the BSC has been mostly reported in organizations facing turbulent environment.

Intensity of competition had the second strongest effect ( $\beta = .308, p = .000$ ), these values support the hypothesis 4 (H4) that intensity of competition has a positive impact on the extent of BSC usage. The literature on BSC concurs with the above result. In this context, Kaplan and Norton (1992) argued that the BSC is a more appropriate approach when the level of market competition is high. This result is also consistent with the empirical work by Banker et al., (2001) who found that companies implementing the BSC operate in competitive markets and face high competitive pressure

Differentiation strategy ranked third ( $\beta = .264, p = .000$ ), these values support the hypothesis 1 (H1) that differentiation strategy has a positive impact on the extent of BSC usage. It was argued in the literature that the increasing use of non-financial performance measures is relatively high in differentiator companies. Therefore, it can be concluded that adopting this type of strategy is related to the extent of BSC usage in enterprises in Viet Nam. The results are consistent with the findings of previous studies. In this vein, Abemethy and Lillis (1995) argued that the choice of performance measurements is dependent on business strategy, and the nature of performance measurements is different according to business strategy (Cauvin and Bescos, 2002).

The factor that had the least effect was TQM ( $\beta = .122, p = .016$ ), these values support the hypothesis 5 (H5) that the extent of the use of total quality management has a positive impact on the extent of BSC usage. The literature on the BSC supports the above result in which the use of total quality management has a positive impact on the extent of BSC usage. It has been argued that today's enterprises environment can be characterised by intensified competition, market changes and high customer demand. These conditions require an enterprise to concentrate more on continuously improving quality and the aspects of total quality management (Johnson and Kaplan, 1987). The TQM concept and implications are consistent with the increasing use of non-financial performance measurements (Banker et al., 1993; Perera et al., 1997). Thus, it can be expected that companies that pursue TQM are more likely to use the BSC approach. Empirical work by Malmi (2001) supported the proposition that one of the important initiatives that encourage the adoption of the BSC is the use of TQM.

The relationship was not found between organizational structure and the usage of BSC ( $\beta = -.102, p = .792$ ),

providing no support the hypothesis 2 (H2) that centralised organization has a positive impact on the extent of BSC usage. Centralisation refers to the hierarchical level that has the authority to make decisions. Therefore, it can be concluded that enterprises with centralised decision-making has no affect on the extent of BSC usage. The negative and non-significant effect of centralisation on the extent of BSC usage contradicts with the argument presented by Braam and Nijseen (2004) in which they argue that the chance of BSC adoption is more likely in high centralised companies. A possible explanation for the non- significant relationship is that almost all of enterprises in Viet Nam is a small and medium- size in term of registered capital, only top managers make decisions and provide direction for the company. Small and medium-size enterprises have not abilities and capabilities to deal with management accounting innovation. They require less elaborate performance evaluation techniques because the strategy setters are more likely to be directly assess the extent to which strategy is being achieved.

All VIF-scores in the regression analysis were below 1.8 confirming that collinearity was not a problem.

## 5. Discussion

This study is an attempt to provide a better understanding of how enterprises in Viet Nam dealing with the BSC concept. In addition, this study has utilised the contingency theory theoretical framework to examine the contingent relationships between BS, OS, PEU, IC, TQM and the extent of usage of BSC. The results indicated that BS, PEU, IC, TQM had a positive significant impact on the extent of usage of BSC while OS had no impact. Operating in high level of competition and perceived environmental uncertainty, enterprises in Viet Nam needing to be innovative, as opposed to solely being efficient, are more likely to adopt a BSC. For differentiation strategy, the usage of a BSC is a critical management choice that facilitates the alignment of the array of decisions made to best match strategic and tactical decisions and activities with environmental requirements. Managers in Viet Nam, faced with external environmental uncertainty, are constantly on the lookout for business systems and tools that would allow them to better coordinate efforts and achieve certainty in results. Enterprises in Viet Nam can achieve better performance when TQM philosophy is in place. Such improved performance can be seen as aggregated improvement in quality of work, external customer satisfaction, safety, market share, effectiveness of planning, labour efficiency, competency in management human resources, risk control and manager's competency. The coordination and stabilizing nature of the BSC are likely key factors in the increasing usage and satisfaction with the BSC

Besides, according to descriptive statistics, this study has provided a lot of important and meaningful information. When respondents were asked if they had encountered any difficulties when applying the BSC model, 16.1% of the respondent did report the problem of 'No clear strategy'. Only 5,1% of respondents said that 'Lack of leadership support' is the most difficult barrier, while 38,2% indicated the "Lack of demand for BSC usage". While in some enterprises in Viet Nam, boards of management are increasingly aware of the importance of adopting a new governance model such as BSC. This deemed to be a fundamental factor to facilitate the promotion of BSC usage. The result of the research also showed many other statistical indices such as the periodicity of indicator measurement, the level of technology usage in the BSC implementation, the extent of BSC usage in businesses and the deploy of consultancy in BSC implementation. This result further explains the correlation between the factors that influence the usage of BSC; while at the same time, it provides important information for managers to make their decisions when deploying the BSC model.

## 6. Implications

For researchers: The summaries and findings of this study addressed significant issues for the researchers. On the basis of contingency theory, there were many controversies in the measurement of variables. This study indicated that variables such as BS, OS, PEU, IC, TQM are multidimensional variables. The IC variable is approached on different aspects such as market competition, product competition, etc. Therefore, detailed evaluation of the influence of every aspect of independent variables is of great significance.

For business executives: BSC is a powerful instrument in strategic management, to progress measurement and effective communication. It has been proven by real business cases in many countries around the world. However, in conditions and circumstances of enterprises in Viet Nam when deploying BSC usage, it is necessary to take prudent steps. Research results is very important for the consideration of decision-making of executives. Based on the results of our research, we would like to make some suggestions as follows:

- . It is necessary to consider and evaluate the influencing factors before deciding to apply the BSC model.
- . Focus on evaluating and improving obstacles and difficulties in applying BSC model in performance evaluation.

For state agencies: In order to promote the effective usage of the BSC model in Viet Nam, in addition to the efforts of enterprises, Government should consider and promulgate appropriate macro policies to support and accelerate the BSC usage. Based on the result of this study, we have several recommendations:

- . The State should have specific guidelines, policies and action programs to popularize and enhance knowledge on BSC model for enterprises.
- . The State should have policies to support and encourage enterprises in Viet Nam to apply modern governance

model in general and BSC model in particular.

. The State should consider to introduce the BSC model to non-profit organizations and administrative bodies to increase performance efficiency and create a premise and motive force for enterprises in Viet Nam to apply this model as soon as possible.

## 7. Limitations and suggestions for further research

There are several limitations to this research:

Firstly, the restriction on the sample. In the quantitative study, although the sample size satisfies the conditions for conducting the analytical methods, non-probability sampling method is not highly representative.

Secondly, the restriction on data collection. The method of data collection is done through questionnaires and online surveys. This is a relatively new method in Viet Nam, some cases survey participants were not collaborative or supportive. This brought about negative impacts on research result.

Lastly, limitations on the scope of the study. The surveyed enterprises have a limited awareness of BSC, while distinctiveness of production and business characteristics between different industries, also affect the research results.

On the basis of the results achieved and the remaining limitations, we would like to suggest several directions for further research as follows:

Firstly, the empirical data for this study are analyzed using only quantitative methods. In future studies, other researchers may wish to engage in more precise qualitative research to evaluate and adjust the scales in accordance with research conditions in Viet Nam.

Second, the results indicate that the model used in this study does not explain around 42% percent of variance in BSC usage. Future research may include other factors that would contribute to this model. Other factors that influence the usage of BSC may be derived from other theories such as agency theory (Govindarajan & Fisher, 1990), social system theory (Walker & Ruekert, 1987), social learning theory (Govindarajan, 1988).

Finally, to obtain a more complete picture, attention should be focused on in-depth study of enterprises based on different type of businesses.

## Reference

- [1] Abemethy, M. and Lillis, A. (1995). The impact of manufacturing flexibility on management control system design. *Accounting, Organizations and Society*, 20 (4), 241-258.
- [2] Al-Dahiyat, M. (2003). Towards an effective design of management control systems: A contingency approach. Unpublished PhD Thesis (University of Huddersfield).
- [3] Anderson, S. and Lanen, W. (1999). Economic transition, strategy and the evolution of management accounting practices: the case of India. *Accounting, Organizations and Society*, 24 (5), 379-412.
- [4] Banker, R., Potter, G. and Schroeder, R. (1993). Reporting manufacturing performance measures to workers: An empirical study. *Journal of Management Accounting Research*, 5 (Fall), 34-55.
- [5] Braam, G. and Nijssen, E. (2004). Exploring determinants of balanced scorecard adoption. The 27th Annual Congress of the European Accounting Association (Prague-Czech Republic).
- [6] Bryman, A. and Cramer, D. (2001). *Quantitative Data Analysis with SPSS Release 10 for Windows*. Routledge
- [7] Bryman, A. and Bell, E., (2007). *Business research methods* (2ed). Great Clarendon: Oxford University Press.
- [8] Cauvin, E. and Bescos, P. (2002). Performance measurement practices: Comparing French start-ups to French and American traditional firms. The 25th Annual Congress of the European Accounting Association (Copenhagen-Denmark).
- [9] Chenhall, R. (2003). Management control systems design within its organizational context: findings from contingency-based research and directions for the future. *Accounting, Organizations and Society*, 28 (2/3), 127-168.
- [10] Chenhall, R. and Morris, D. (1986). The impact of structure, environment and interdependence on perceived usefulness of management accounting systems. *The Accounting Review*, 61 (1), 16-35.
- [11] Chow, C., Haddad, K. and Williamson, J. (1997). Applying the balanced scorecard to small companies. *Management Accounting (USA)*, 79 (2), 21-27.
- [12] Euske, K., Lebas, M. and McNair, C. (1993). Performance management in an international setting. *Management Accounting Research*, 4 (4), 275-299.
- [13] Eric Tanyi, (2011). Factors influencing the use of Balanced Scorecard. Unpublished MAS Thesis (Hanken School of Economics).
- [14] Francis, G. and Minchington, C. (2000). Value-based management in practice. *Management Accounting (UK)*, 78 (2), 46-47.
- [15] Gosselin, L. (1997). The effects of strategy and organizational structure on the adoption and implementation of activity-based costing. *Accounting, Organizations and Society*, 22 (2), 105-122.
- [16] Govindarajan, V. (1984). Appropriateness of accounting data in performance evaluation: An empirical

- examination of environmental uncertainty as an intervening variable. *Accounting, Organizations and Society*, 9 (2), 125-135.
- [17] Govindarajan, V. (1988). A contingency approach to strategy implementation at the business-unit level: Integrating administrative mechanisms with strategy. *Academy of Management Journal*, 31 (4), 828-853.
- [18] Govindarajan, V. and Fisher, J. (1990). Strategy, control systems and resource sharing: Effects on business unit performance. *Academy of Management Journal*, 33 (2), 259-285.
- [19] Hair, J. F., W. C. Black, B. J. Babin and R. E. Anderson (2014). *Multivariate data analysis*. Pearson Education Limited, Harlow.
- [20] Hoque, Z. (2003). Total quality management and the balanced scorecard approach: A critical analysis of their potential relationships and directions for research. *Critical Perspectives on Accounting*, 14 (5), 553-566.
- [21] Hoque, Z. and James, W. (2000). Linking balanced scorecard measures to size and market factors: Impact on organizational performance", *Journal of Management Accounting Research*, 12, 1-17.
- [22] Hoque, Z., Mia, L. and Alam, M. (2001). Market competition, computer-aided manufacturing and use of multiple performance measures: An empirical study. *British Accounting Review*, 33 (1), 23-45.
- [23] Ittner, C. and Larcker, D. (2001). Assessing empirical research in managerial accounting: a value-based management perspective. *Journal of Accounting and Economics*, 32 (1/3), 349-410.
- [24] Ittner, C., Larcker, D. and Meyer, M. (2001). The anatomy of a balanced scorecard bonus plan. Unpublished Working paper, (University of Pennsylvania).
- [25] Johnson, H. and Kaplan, R. (1987). *Relevance lost: the rise and fall of management accounting*. Boston, MA: Harvard Business School Press.
- [26] Kaplan, R. and Norton, D. (1992). The balanced scorecard measures that drive performance. *Harvard Business Review*, 70 (1), 71-79.
- [27] Kaplan, R. and Norton, D. (1996). Using the balanced scorecard as a strategic management system. *Harvard Business Review*, 74 (1), 75-85.
- [28] Krumwiede, K. (1998). The implementation stages of activity-based costing and the impact of contextual and organizational factors. *Journal of Management Accounting Research*, 10, 239-277.
- [29] Lawrence, P. and Lorsch, J. (1967). *Organization and Environment*. Boston: Harvard Business School, Division of Research.
- [30] Lee, J. and Miller, D. (1996). Strategy, environment and performance in two technological contexts: Contingency theory in Korea. *Organization Studies*, 17 (5), 729-750.
- [31] Malmi, T. (2001). Balanced scorecards in Finnish companies: A research note. *Management Accounting Research*, 12 (2), 207-220.
- [32] Maltz, A., Shenhar, A. and Reilly, R. (2003). Beyond the balanced scorecard: Refining the search for organizational success measures. *Long Range Planning*, 36 (2), 187204.
- [33] Majdy, Z. (2005). Performance measurement systems: an examination of influence of contextual factors and their impact on performance with specific emphasis on the Balanced Scorecard approach. Unpublished PhD Thesis (University of Huddersfield).
- [34] Olson, E. and Slater, S. (2002). The balanced scorecard, competitive strategy, and performance. *Business Horizons*, 45 (3), 11-16.
- [35] Otley, D. (2001). Extending the boundaries of management accounting research: Developing systems for performance management. *British Accounting Review*, 33 (3), 243261.
- [36] Otley, D. and Wilkinson, C. (1988). Organizational behaviour: strategy, structure, environment and technology. *Behavioural accounting research: a critical analysis*. 147-170
- [37] Pallant, J. (2001). *SPSS Survival manual: A step by step guide to data analysis using SPSS for windows*. Versions 10 and 77, (Open University Press).
- [38] Perera, S., Harrison, G. and Poole, M. (1997). Customer-focused manufacturing strategy and the use of operation-based non-financial performance measures: A research note", *Accounting, Organizations and Society*, 22 (6), 557-572.
- [39] Porter, M. (1980). *Competitive Strategy Techniques for Analyzing Industries and Competitors*. New York: Free Press.
- [40] Sohn, M., You, T., Lee, S. and Lee, H. (2003). Corporate strategies, environmental forces, and performance measures: a weighting decision support system using the k-nearest neighbour technique. *Expert Systems with Applications*, 25 (3), 279-292.
- [41] Speckbacher, G., Bischof, J. and Pfeiffer, T. (2003). A descriptive analysis on the implementation of balanced scorecards in German-speaking countries. *Management Accounting Research*, 14 (4), 361-387.
- [42] Watson, R. (2001). *SPSS Survival Manual*. Open University Press, Buckingham
- [43] Wang, Y.S., Wang, Y.M., Lin, H.H., and Tang, T.I., (2003). Determinants of user acceptance of Internet banking: an empirical study. *International Journal of Service Industry Management*, 14 (5), 500-519.



The Appendix

Figure 1. The research model

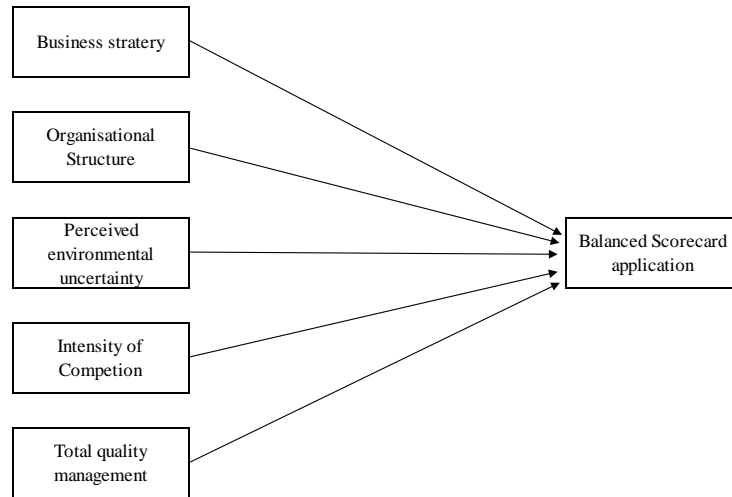

Table 2: Demographics summary of the respondents. (n=217)

Measure	Items	Frequency	Percentage
<b>Gender</b>	Female	110	51%
	Male	107	49%
<b>Age</b>	Below 30	50	23%
	30-40	55	25%
	41-50	100	46%
	Above 50	12	6%
<b>Tunure in Current position</b>	Less than 5 years	10	5%
	5-10 years	192	88%
	More than 10 years	15	7%
<b>Current Position</b>	CEO	4	2%
	Director	15	7%
	Head of department	20	9%
	Staff	168	77%
	Other	10	5%
<b>Company's Property</b>	State-owned	3	1%
	Private	41	19%
	Limited	45	21%
	Joint stock	105	48%
	Joint Venture	2	1%
	Foreign- Owned	2	1%
	Other	19	9%
<b>Company's Type</b>	Manufacturing	44	20%
	Trading	72	33%
	Services	73	34%
	Other	28	13%

**Table 1. The constructs of the adapted research model with relevant studies**

<b>Intems</b>	<b>Measurement from literature</b>	<b>Literature</b>
Business strategy (BS)	BS1. Product quality	Govindarajan (1988), Lee and Miller (1996)
	BS2. Brand image	
	BS3. Product features	
Organisation Structure (OS)	OS1. New product introduction decisions are made only at the highest management level	Ramäuthy (1990) Al-Dahiyate (2003)
	OS2. Apart from minor investments, capital budgeting decisions are usually made only at the top management level	
	OS3. Decisions to attempt penetration into new markets generally are made only by top management	
	OS4. Decisions on major changes to (including new introduction of) manufacturing processes are made only at the top management level	
	OS5. Personnel policy decisions are usually made by top management	
	OS6. Pricing policies are set only by top management	
Perceived environmental uncertainty (PEU)	PEU1. Manufacturing technology	Govindarajan (1984)
	PEU2. Competitors' actions	
	PEU3. Customers' demand	
	PEU4. Product attributes/design	
	PEU5. Raw material availability	
	PEU6. Raw materials price	
	PEU7. Government regulation	
	PEU8. Labour unions actions	
Intensity of competition (IC)	IC1. Price competition	Guilding and McManus (2002)
	IC2. Competition for selling and distribution	
	IC3. Competition for quality and variety of products	
	IC4. Competition for market share	
	IC5. Competition relating to customer service	
	IC6. Number of competitors in your market segment	
	IC7. Competitors' actions	
Total quality management (TQM)	TQMI. Workers are rewarded for quality improvement	Banker et al. (1993) Krumwiede (1998)
	TQM2. Experiments to improve the quality of processes are frequently conducted	
	TQM3. Quality benchmarking with other companies or business units is tracked	
	TQM4. Employee teams are functioning and have been effective	
	TQM5. Total quality management, whereby most business functions are involved in a process of continuous quality improvement, is an extremely high priority	
Balanced scorecard usage (BSC)	BSC 1. Do you find financial measures to be more appropriate to present the performance of your organization than non-financial measures	Eric Tanya (2011)
	BSC 2. In order to exercise your function how often do you financial or non-financial information	
	BSC 3. In order to exercise your function do you find qualitative information more use than quantitative	

**Table 3. Type of perspective used in performance measurement**

Type of perspective	Frequency	Percent
Financial	217	100.0%
Customer	215	99.1%
Internal business process	202	93.1%
Learning and growth	150	69.1%
Supplier	168	77.4%
Employee	58	26.7%
Other perspective	25	11.5%
<b>Total</b>	<b>217</b>	<b>100.0%</b>

**Table 5: Correlations Matrix**

Variables	N	Mean	SD	1	2	3	4	5	6
1 BS	217	3.1091	.98543	1					
2 OS	217	3.0484	1.17111	-.197**	1				
3 PEU	217	3.6995	.90761	.299**	-.205**	1			
4 IC	217	3.5779	.95601	.425**	-.304**	.594**	1		
5 TQM	217	3.6025	.79176	.183**	.067	.360**	.417**	1	
6 BSC	217	3.5653	.94606	.516**	-.216**	.630**	.666**	.414**	1

\*\* . Correlation is significant at the 0.01 level (2-tailed).

**Table 6. Regression Analysis**

	B	SD	β (Beta)	T	Sig.	Collinearity Statistics	
						Tolerance	VIF
(Constant)	-.049	.275		-.178	.859		
BS	.253	.047	.264	5.444	.000	.811	1.232
OS	-.010	.038	-.012	-.264	.792	.853	1.173
PEU	.336	.058	.322	5.836	.000	.626	1.597
IS	.305	.061	.308	5.017	.000	.507	1.974
TQM	.146	.060	.122	2.438	.016	.763	1.310
Adjusted R Square	.588						
F	62.613						
Sig	.000						

<b>Table 4. The Result of the reliability test and factor analysis</b>				
<b>Construct Factors</b>	<b>Items</b>	<b>Cronbach' s alpha</b>	<b>Corrected Item-total Correlation</b>	<b>Factor loading</b>
Business strategy (BS)	BS1. Product quality	.819	.688	.826
	BS2. Brand image		.717	.877
	BS3. Product features		.614	.756
Organisation Structure (OS)	OS1. New product introduction decisions are made only at the highest management level	.904	.718	.804
	OS2. Apart from minor investments, capital budgeting decisions are usually made only at the top management level		.757	.816
	OS3. Decisions to attempt penetration into new markets generally are made only by top management		.703	.796
	OS4. Decisions on major changes to (including new introduction of) manufacturing processes are made only at the top management level		.780	.834
	OS5. Personnel policy decisions are usually made by top management		.692	.783
	OS6. Pricing policies are set only by top management		.771	.845
Perceived environmental uncertainty (PEU)	PEU1. Manufacturing technology	.747	.240*	
	PEU2. Competitors' actions		.280*	
	PEU3. Customers' demand		.291*	
	PEU4. Product attributes/design		.542	.725
	PEU5. Raw material availability		.614	.809
	PEU6. Raw materials price		.498	.721
	PEU7. Government regulation		.595	.811
	PEU8. Labour unions actions		.576	.769
Intensity of competition (IC)	IC1. Price competition	.857	.792	.832
	IC2. Competition for selling and distribution		.785	.867
	IC3. Competition for quality and variety of products		.736	.791
	IC4. Competition for market share		.720	.758
	IC5. Competition relating to customer service		.689	.691
	IC6. Number of competitors in your market segment		.396*	
	IC7. Competitors' actions		.293*	
Total quality management (TQM)	TQM1. Workers are rewarded for quality improvement	.771	.534	.756
	TQM2. Experiments to improve the quality of processes are frequently conducted		.460	.691
	TQM3. Quality benchmarking with other companies or business units is tracked		.543	.747
	TQM4. Employee teams are functioning and have been effective		.583	.484
	TQM5. Total quality management, whereby most business functions are involved in a process of continuous quality improvement, is an extremely high priority		.602	.555
Balanced scorecard usage (BSC)	BSC 1. Do you find financial measures to be more appropriate to present the performance of your organization than non-financial measures	.850	.628	.852
	BSC 2. In order to exercise your function how often do you financial or non-financial information		.648	.853
	BSC 3. In order to exercise your function do you find qualitative information more use than quantitative		.691	.877

The number with \* was excluded from the model

International Conference For Young Researchers In Economics And Business, ICYREB 2017, October 30<sup>th</sup> 2017  
Da Nang, Vietnam

# Purchase Intention towards Green Products Selling at Supermarkets in Ho Chi Minh City, Vietnam

Nguyen Tuan Duong<sup>a</sup>, Le Huu Phuoc<sup>b</sup>, Nguyen Huynh Ngoc Tram<sup>a,b\*</sup>

<sup>a</sup>Foreign Trade University Ho Chi Minh City Campus, 15 D5, Ward 5, Binh Thanh District, Ho Chi Minh City, 70000, Vietnam

<sup>b</sup>Foreign Trade University Ho Chi Minh City Campus, 15 D5, Ward 5, Binh Thanh District, Ho Chi Minh City, 70000, Vietnam

<sup>a,b</sup>Foreign Trade University Ho Chi Minh City Campus, 15 D5, Ward 5, Binh Thanh District, Ho Chi Minh City, 70000, Vietnam

## ABSTRACT

The trend of purchasing green products to promote sustainable development and protect the environment is growing strongly among countries in the world. There is a gap in the perception of both Vietnamese consumers and corporations towards green products compared to that of other countries in Asia. Therefore, the main objective of this study is to identify the influence level of critical factors on consumers' purchase intention towards green products. A combination of preliminary qualitative method and quantitative method including factor analysis and multivariate regression analysis was used to measure the extent of the influence of these factors. With a set of 208 usable samples collected from respondents in Ho Chi Minh City, Vietnam processed by SPSS 20.0 software, the results of this study showed that there are four main factors determining consumers' purchase intention towards green products in the supermarkets in Ho Chi Minh City, Vietnam including: (1) Health consciousness, (2) Perceived Consumers' Effectiveness, (3) Eco-label and (4) Attitude towards green products. Based on these findings, this paper proposes recommendations for the Vietnamese government and corporations in order to have a sustainable development plan for green products.

**Keywords:** green products; purchase intention; supermarket; eco-label; Vietnam

## 1. Introduction and literature review

### 1.1. Introduction

With the rapid development of industrialization, modernization and population, the world has been facing a set of environmental issues. Therefore, consumers have been becoming more and more concerned about environmental issues and applying more practices to reduce environmental degradation (Mahalingam, 2011). Accordingly, environmental protection practices and green movement have found place among businesses and markets (Kassaye, 2001). Governments, researchers and corporations have been making commitments towards environmental protection. At the Climax Change Conference held in Copenhagen in 2009, green consumption was considered as a global trend. Researchers had shown that consumers started to recognize the impact of green products on the environment.

Vietnam is not an exception on being in such kind of environmental problems. According to a research on Environmental Sustainability Index publicized by Yales University in 2016, Vietnam placed among top 10 countries facing the most serious air pollution problem that had a strong effect on human's health. In the action of protecting the environment, the Vietnamese Government has made continuous and long-term efforts to increase consumers' environmental awareness and encourage citizens to consume green products. For example, the worldwide Earth Hour environmental campaign has been significantly supported by the Vietnamese Government, consumers and corporations (Thu 2014).

There are only few studies on green products in Vietnam. One typical research was done on factors influencing young people's green purchasing intentions in the South Central provinces (Nguyen Ba Phuoc, 2015). As for Vietnamese's consumers, the definition of green products is not yet clear and consistent to them. As for corporations, they have not found an effective way to help consumers approach green products. According to Mrs. Phung Thi Ai Van,

\* Corresponding author. Tel.: ++841688707996  
E-mail address: tramnguyen.adc@gmail.com

the head of organization board of Green Consumption Campaign hosted by the People's Committee of Ho Chi Minh City, among the corporations whose products are granted "the eco-label", there are few that utilize this eco-label to approach customers.

For these reasons, the authors decided to implement the research on purchase intention towards green products selling at supermarkets in Ho Chi Minh City, Vietnam which is a major economic, political, cultural and social center of Vietnam. The purpose of the research is to find out the influencing level of factors affecting purchase intention towards green products selling at supermarkets in Ho Chi Minh City, Vietnam and thereby give recommendations to the government and corporations to promote purchase intention towards green products.

The paper focuses on three main research objectives, including:

- Synthesizing existing theories in the world on green purchase intention and related issues.
- Finding out factors affecting people's purchase intention towards green products and their influencing level.
- Giving recommendations for the government, corporations and shoppers themselves to promote the purchase intention towards green products to contribute to the sustainable development plan of the country.

## 1.2. Literature review

The concept of purchase intention towards green products is becoming the focus of study for policymakers and researchers. There are a number of papers related to this topic such as: Study of factors affecting young consumers to choose green products (Dr. Mohammad Reza Iravani, Mohammad Sadeghi Zadeh, Amerreza Forozia, Norsida Shafaddin and Hamidreza Mahroeian, 2012) and Theory of Planned Behaviour Approach to understand the purchasing behaviour for environmentally sustainable products (Kumar, 2012). The study on consumers' intention to buy green products: Insights from Malaysia (Azizan and Suki, 2013) is to analyze the factors affecting the purchase intentions of green products of young Malaysian consumers and to propose some solutions to enhance their green marketing activities. This study explores the intention of young consumers based on the Theory of Planned Behavior (TPB). The author selected 300 observations from University Teknologi Malaysia and Multimedia University. Through the descriptive statistics, correlation and regression analysis, the author has identified four variables including customer belief, social influence, attitude toward the environment and the perceived quality of the green products which have a significant influence and positive impact on the purchase intention towards the green products of young Malaysian consumers. However, this study focuses on the Malaysian market only.

The Theory of Planned Behavior has also been applied to the study of Vietnamese authors such as Factors influencing young people's green purchasing intentions in the South Central provinces (Nguyen Ba Phuoc, 2015); Understanding Vietnamese consumers' purchase of electronic resources in Ho Chi Minh City (Nguyen Thi Huong Giang and Ho Ngoc Tran, 2014).

## 2. Theoretical Framework

### 2.1. Definition of Green Products

According to Shamdasani et al.(1993), green products are defined as the ones that help sustaining the Earth by protecting and preserving the nature, and will not pollute or cause any harmful impact on the natural environment. In the research of Schlegelmilch et al. (1996), the green products are made from the recycled materials, not tested on animals and in eco-friendly processes; they could also be organically-grown fruit and vegetables which are produced in a power-saving ways without causing greenhouse effects. By Chen and Chai (2010), the process used to create green products consumes non-toxic and recycled materials or less packaging to reduce environmental impacts.

By Ottman (1998), green products are robust and non-toxic, using minimum package. However, there are no completely green products considering the fact they are all made using power and other resources. Moreover, there is the amount of exhaust gas emitting during the manufacturing and transporting process. Therefore, the definition of green products is relative and in general, green products are those which have good impacts on the environment compared to other products.

In Vietnam, Decree-Law of "Incentives and Supports for Environmental Activities" (2009) states that "Green products are ones which have less damage to the environment during the process of exploitation, manufacturing, storing, usage and elimination than other products of the same type. Green products must be certified by the Government and marked with "eco-label". In Vietnam, considering legal, social and ecological aspects, a product, in order to be labeled "green", must meet the following requirements:

It must be made from the environment-friendly materials.

It offers better solutions for the environment and consumer health compared to conventional (unsafe) products.

It has a less harmful influence on the environment (reduce the amount of waste disposal, maintenance cost and use renewable energy).

It creates a friendly and safe environment for human health.

**2.2. Definition of green purchasing intention**

A green purchasing intention is a specific form of environment-friendly behaviours which is represented as the environment consciousness of the customers (Zia-ur-Rehman and Dost, 2013). Furthermore, the theory of reasoned actions is widely accepted to explain the green purchase behaviour of the customers. It is applied to confirm that environmental concern of the consumers will determine their actual behaviours and green purchase behaviours (Albayrak et al., 2013). Moreover, the Theory of Planned Behaviour (Ajzen,1991) has confirmed that purchase intention is a crucial factor of the actual purchase behaviour of the customer. It means that the increment of green purchase intentions will rise the probability that the customers actually buy the green products.

**2.3. Related research models**

2.3.1. Study model by Kumar (2012)

Based on the Theory of Planned Behaviour (Ajzen, 1991), the study model by Kumar (2012) has indicated the following factors influencing purchase intention towards green products including: (1) Attitude, (2) Subjective Norm, (3) Perceived Behaviour Control.

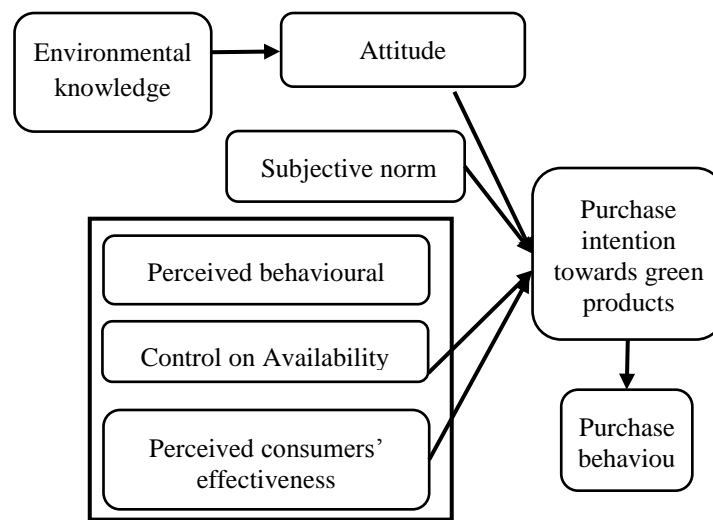
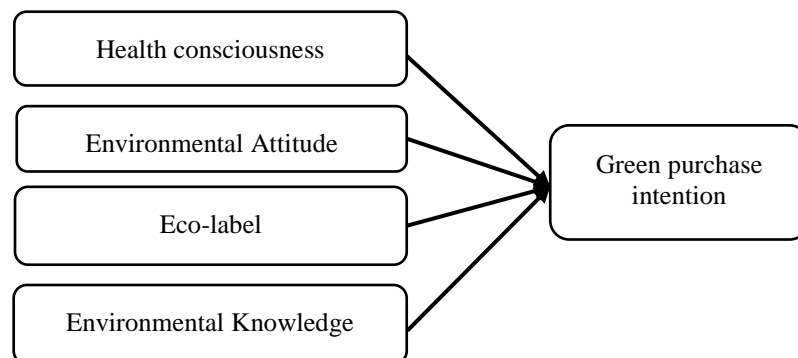

**Figure 2.1: Kumar’s research model (2012)**

Source: Kumar (2012)

2.3.2. Study model by Azizan and Suki (2013)

The study by Azizan and Suki has addressed four factors having an influence on the green purchase intention: (1) Health Consciousness, (2) Environmental Attitude, (3) Eco-label, (4) Environmental Knowledge.



**Figure 2.2: Study model by Azizan and Suki (2013)**

Source: Azizan and Suki (2013)

2.3.3. Study model by Rashid (2009)

Rashid has indicated three factors influencing purchase intention towards green products including (1) Attitude towards environmental protection, (2) Environmental knowledge, (3) Eco-labels.

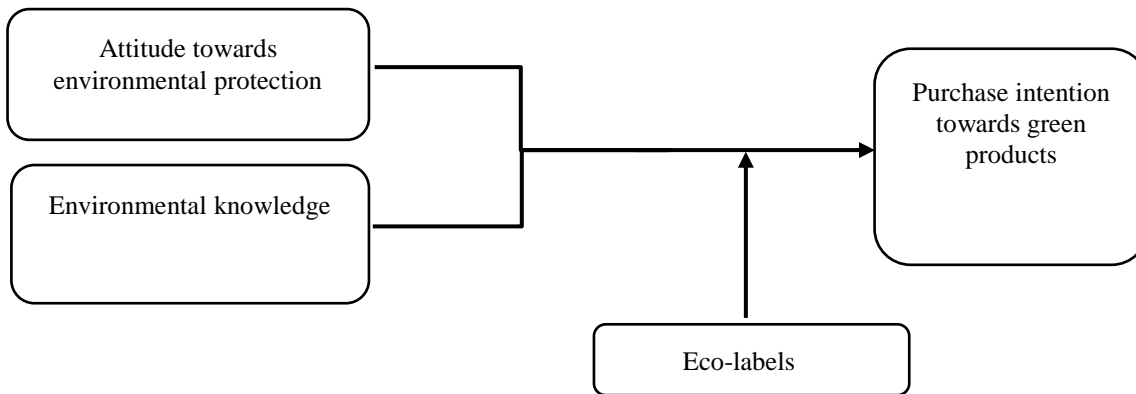

Figure 2.3: Study model by Azizan and Suki (2013)

Source: Azizan and Suki (2013)

Based on the fundamental knowledge and the outcome of related researches, the authors have chosen five research variables for the study on purchase intention towards green products at the supermarkets in Ho Chi Minh City, Vietnam as follows:

- **Attitude towards green products:** According to Ajzen (1999), the attitude which is considered as a scale of approval or disapproval of a particular action plays an essential role in controlling the customer’s intentions and actions. Moreover, a person is more likely to conduct an action when he/she has positive evaluation about this action. Research “A hierarchical analysis of the green consciousness of the Egyptian consumer” (Mostafa, 2007) shows that the factor influencing customer’s attitude towards the green products may influence the intention of purchasing the green products and therefore directly impacts on the buy of green products. Follows and Jobber (2000) have found the connection between product’s value, purchasing attitude and buying action.

- **Social Influence:** According to Ajzen (1991), social factor is considered as “subjective norm” – social pressure which decides whether the behaviour is performed or not. Therefore, the customers are more likely to have the green product purchase intention when they received approval (or positive advice) from their group of references. The group of references could be the customer’s friends, family, neighbours or even the mass-media. Among those, friends and mass-media have the most significant influence on the customer’s behaviours (Bindah and Othman, 2012). The prior researches (Feick et al. (2003) [11], Lee (2008) and Lu (2014)) also support the conclusion that the social factor has the positive impact on the intention of green purchasing.

- **Health Consciousness:** According to Becker et al. (1977), personal’s responsibility for health is the willingness to adjust his/her actions to get healthier. The customers who have responsibility for health are always aware and understand their well-being. These people concern of improving their strength and quality of their life to prevent disease by having a healthier lifestyle (Newson et al.,2005). The researches of Salleh et al. (2010) and Azizan and Suki (2013) have confirmed the positive influence of health consciousness on the intention of green purchasing of Malaysian customers.

- **Perceived Consumer Effectiveness:** Straughan and Robert (1999) and Vermeir and Verbeke (2008) have proved the relationship between environmental concern and the perceived consumer effectiveness. According to the summary of researches about purchasing behaviour toward green product from 2000 to 2014 (Joshi and Rahman, 2015), the perceived consumer effectiveness is one of the most commonly investigated variables. The researches of Gleim et al. (2013) and Gupta and Ogden (2009) have given the same positive relationship between the perceived consumer effectiveness and the intention of green purchasing.

- **Environmental label or Eco-label:** From the marketer’s aspect, environmental label is effective market tool to advertise the potential benefits, special properties of green products and the guarantee of product’s quality (D’Souza et al., 2006; Sonderskov and Daugbjerg, 201) as well as the environmental improvement relating to customer’s green purchasing (Rashid, 2009).Researches of Nik Abdul Rashid (2009) and Bao (2015) have determined the positive impact of the environmental label on the green purchasing intentions of the customers.

Five primary factors mentioned above are used in the proposed model with the scales based on the research by Kumar (2012), Othman (2012), Vermier and Verbeke (2008) and Wilson et al. (2014). From the reference scales, the authors have modified and proposed a new scale which is more suitable and practical to this research objectives for Vietnamese consumers. From there, the research model is introduced as follows:



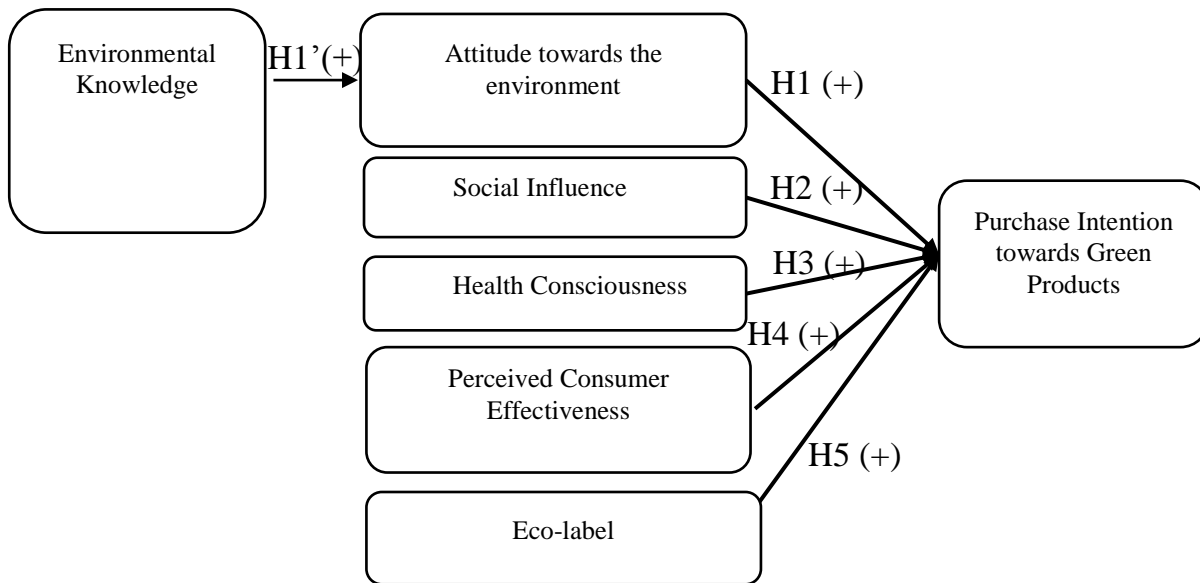

**Figure 2.3: The proposed study model**

Source: Compiled by the authors

### 3. Research Methodology

#### 3.1. Preliminary research methods

The authors establish the preliminary research stages as follows:

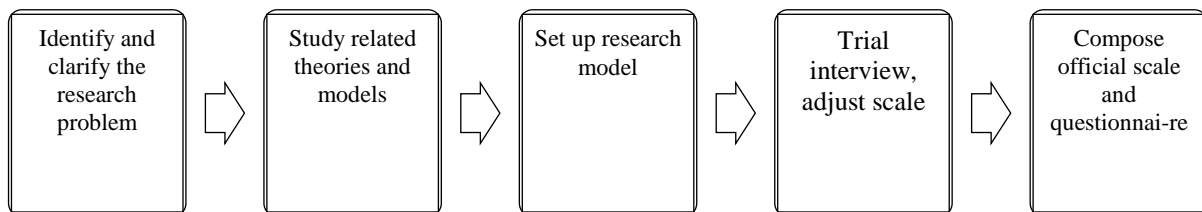

**Figure 3.1: Preliminary research process**

Source: Compiled by the author

#### 3.2. Official research methodology

The authors selected the official data collection method as in-person surveys and online surveys. After conducting the survey and cleaning the data collected, the team analyzed using SPSS analysis software 20.0. The application of quantitative research methods includes: assessing the reliability of the scale through Cronbach's Alpha Reliability Coefficient analysis, analyzing the EFA Discovery Factor to group factors and eliminating inappropriate variables. The result will be through the Pearson Correlation Coefficient analysis. A regression analysis is conducted to discover the relationship between the factors and purchase intention towards green products selling at supermarkets in Ho Chi Minh City, Vietnam. The one-way analysis of variance (ANOVA) is used to determine whether there are any statistically significant differences between the means of independent groups. Based on the result, the recommendations are proposed to the Vietnamese government, corporations and the consumers to increase the purchase intentions towards green products.

### 4. Result from the research

Based on the research's result and data analysis, the authors have chosen 22 factors (belong to 5 groups) which influence consumers' purchase intention towards green products at the supermarkets in Ho Chi Minh City, Vietnam.

**Table 4.1: Mean of independent variables**

Variables		Samples	Mean value
<b>Attitude towards green products (AGP)</b>		208	
AGP1	I believe that using green products will help reducing pollution and improve the environmental quality	208	4,22
AGP2	I believe that using green products will help to reduce wasting natural resources	208	4,06
AGP3	I believe that using green products will help to preserve natural resources	208	4,00
AGP4	I feel useful when I am using green products	208	4,02
<b>Social impacts (SI)</b>		208	
SI1	My friends introduce and encourage me to use green products	208	3,39
SI2	My family introduce and encourage me to use green products	208	3,33
SI3	I have the intention to purchase green products since I see their advertisement on TV, radio and newspapers	208	3,28
SI4	I have the intention to purchase green products since it helps me get along with my friends, family and colleagues	208	2,86
<b>Health consciousness (HC)</b>		208	
HC1	I care about my family's health	208	4,21
HC2	I care about my health	208	4,10
HC3	I always care and pay attention to my health change	208	3,99
<b>Perceived Consumer's Effectiveness (PCE)</b>		208	
PCE2	I believe that I can support to solve environmental problem	208	3,70
PCE3	I believe that I can support to solve environmental problem by saving water and energy resources	208	3,99
PCE4	I am purchasing the green products; normally search for the impacts of these products on the environment and people	208	3,77
<b>Eco-label (EC)</b>		208	
EC1	I think the green advertisements are trustworthy	208	3,24
EC2	I think the content in eco-label is always proper	208	3,06
EC3	I think the content in eco-label is understandable	208	3,11
EC4	I think eco-label is prerequisite to considering a product as green product	208	3,11
EC5	I think the content in eco-label is sufficient	208	3,14

Source: From the research data, SPSS, 2017

Based on this result, the authors have built the regression model of purchase intention towards green products with the hypothesis that the purchase intention towards green products (PI) depends on 5 factors: Attitude towards the Green Products (AGP), Social Influence (SI), Health Consciousness (HC), Perceived Consumer Effectiveness (PCE) and Eco-label (EC). These independent factors have a positive correlation to purchase intention towards green products selling at supermarkets in Ho Chi Minh City, Vietnam. The result of the research is displayed in Table 4.2 as below.

**Table 4.2: Result of Regression coefficients**

Model	Unstandardized Coefficients		Standardized Coefficients	t	Sig.	Collinearity Statistics	
	B	Std. Error	Beta			Tolerance	VIF
Consta-nt	0,210	0,183		1,149	0,252		
AGP	0,159	0,050	<b>0,176</b>	3,200	0,002	0,520	1,924
SI	-0,051	0,044	<b>-0,058</b>	-1,152	0,251	0,609	1,642
HC	0,379	0,047	<b>0,400</b>	8,132	0,000	0,648	1,544
PCE	0,263	0,046	<b>0,307</b>	5,681	0,000	0,537	1,862
EC	0,184	0,049	<b>0,193</b>	3,791	0,000	0,602	1,661

Source: From the research data, SPSS, 2017

The result of regression analysis shows that there is no multicollinearity in the proposed model since the value of tolerance is greater than 0.1 and VIF coefficient of the variables is less than 10. Moreover, sig. value of four factors: AGP, HC, PCE and EC are all less than 0.05. Therefore, these independent factors affect the purchase intention towards green products. However, the sig. value of the variable SI is greater than 0.251; therefore, the regression coefficient of this variable does not have a statistical significance. The standardized regression value of the independent variables in this mode is as follows: Attitude toward the green products' standardized regression value is 0.176; Health consciousness' standardized regression value is 0.400; Perceived Consumer's Effectiveness' standardized regression value is 0.307; Eco-label's standardized regression value is 0.193.

It can be seen that there is 4/5 primary hypotheses of the proposed model are supported at the sig. level of 5%. The hypothesis H2 "Social Influence has a positive correlation to the purchase intention towards green products" is rejected. The Hypothesis testing results are summarized in Table 4.3 as below.

**Table 4.3: Hypothesis testing results**

No.	Hypothesis	Result	Beta	Sig
H1'	Environmental knowledge has a positive correlation to the purchase intention towards green products	Supported	0,851	0,000
H1	Attitude toward the green products has a positive correlation to the purchase intention towards green products	Supported	0,176	0,002
H2	Social Influence has a positive correlation to the purchase intention towards green products	Rejected	-0,058	0,251
H3	Health consciousness has a positive correlation to the purchase intention towards green products	Supported	0,400	0,000
H4	Perceived Consumer's Effectiveness has a positive correlation to the purchase intention towards green products	Supported	0,307	0, 000
H5	Eco-label has a positive correlation to the purchase intention towards green products	Supported	0,193	0,000

Source: From the research data, SPSS, 2017

Result overview:

- The output of regression analysis shows that the coefficient Beta of social influence factor has the negative value (Beta = -0.058) with Sig. value = 0.251 > 0.05. Therefore, the purchase intention towards green products is not affected by the social influence.

- Estimated results show that health consciousness has the most significant impact on the purchase intention

towards green products, as shown in the Beta = 0.400 with Sig. value = 0.000. This means that the higher the consumer's awareness about their health is, the greater chance the consumers have the intention to buy green products. They are aware that their green purchasing contributes to preserve the environment as well as protect their own health.

- The relationship between perceived consumer effectiveness and purchase intention towards green products is 0.037 with Sig. value = 0.000<0.05. When the consumers are aware of the benefits of using green products to the community and society, they are more likely to buy and use green products.

- The relationship between eco-label and purchase intention towards green products is 0.193 with Sig. value = 0.000<0.05. This means that eco-label supports the purchase intention towards green products of the customers.

- The adjusted R<sup>2</sup> coefficient of 67.6% means that 67.6% of the variation of the dependent variables of purchase intention towards green products is explained by four groups of factors. The remaining 32.4% is due to errors and other variables absent in the model.

- Based on ANOVA analysis, there are the differences in purchase intention towards green products per age and income as they satisfy the condition that Sig. value of Levene Statistic is more than 0,05 and Sig. value is less than 0,05. To be specific, the older and high-income customers are more likely to purchase and consume green products. Meanwhile, the other demographic factors such as gender and education level have no effect in the purchase intention towards green products in this study.

**Table 4.4: ANOVA Test of Homogeneity of Variances**

Characteristics	Sig. value of Levene Statistic	Sig.
Gender	0,829	0,253
Age	0,651	0,000
Education level	0,367	0,138
Income	0,290	0,002

Source: From the research data, SPSS, 2017

## 5. Recommendations

### 5.1. Recommendations for government and enterprises

#### 5.1.1. Recommendations for the government

Based on the results of the study, the authors come up with three suggestions for the government as follows:

Firstly, it should combine the contents of environmental situation and the negative impact of pollution on the human health into the educational programs. It is a potential solution to improve the health consciousness of people so that it could promote the consumer's intention of green products purchasing.

Secondly, it should encourage the environmental activities such as Green Consuming Campaign, or Earth Hour to help the people understand the values and benefits of these activities towards the society.

Finally, it should update the list of products which have the environmental label. Besides, the government should also encourage the enterprises/manufacturer to register environmental label when their products meet the environmental requirements.

#### 5.1.2. Recommendations for corporations

Corporations should take the environment and human health into consideration as the primary points of their advertising campaign.

Corporations should consider emphasizing the relationship between using green products and environmental impact in their advertising campaign.

Corporations should understand the process to achieve the environmental label and register it when their products satisfy the requirement. These solutions are able to be applied by the government and the enterprises. Nowadays, the environmental label has been applied by the Ministry of Natural Resources and Environment via Circular No. 41/2013/TT-BTNMT. This Circular gives the instruction how to register the environmental label for the green products.

#### 5.1.3. Recommendations for consumers

Besides the suggestions for the government and enterprises as mentioned in the previous sections, the authors also provide some recommendations for the consumers who have the intention to purchase green products.

Firstly, the consumers should think carefully about the product's influence on their (or their family's) health before purchasing. For more details, in addition to expiry date, usage and origin of the products, the consumers should also search for the information about the package and the ingredient of the product to make sure there is no harm for their health.

Secondly, the consumer should also consider about information given in environmental label of the product. The products which have a (legal) environmental label are certified their safety for the environment and consumers' health. In Vietnam, there is only one type of environmental label called "Vietnamese Green label" which is approved and released by the Ministry of Natural Resources and Environment.

Finally, the consumers should participate in the green purchasing campaigns which are organized by the government and the supermarkets in Ho Chi Minh City to improve their knowledge about the environment and green products. By doing that, the consumers could choose the best quality products for themselves and their family.

## 6. Conclusion

Given that the environmental problems are increasingly concerned, this research on purchase intention towards green products selling at supermarkets in Ho Chi Minh City, Vietnam identifies and evaluates the influencing level of factors affecting purchase intention towards the green products, thereby offering some recommendations for the government, corporations and consumers to find a sustainable development path for green behaviors for the environmental goals.

With 208 valid samples processed by SPSS 20.0 software using the EFA analysis, the study identifies 4 factors that affect the purchase intention towards green products including (1) Health consciousness, (2) Perceived Consumer Effectiveness, (3) Eco-label, (4) Attitude towards green products. In particular, health consciousness and perceived consumer effectiveness have the strongest impact on the purchase intention. Conversely, the impact of attitude towards green products is minimal. The result of the regression analysis also demonstrates that social influence does not affect the intention to purchase green products of people in Ho Chi Minh City, Vietnam. In addition, the hypothesis of the environmental knowledge has a positive impact on the attitude towards green products is also supported. Accordingly, the content of the environment and human health should be integrated into marketing campaigns of corporations as well as in educational programs at all levels to help people recognize the value and benefits of eco-friendly products for the sake of themselves and the community.

## References

- [1] Ajzen, I. (1991). The Theory of Planned Behavior. *Organizational Behavior and Human Decision Processes*, 50(2), 179-211.
- [2] A. Tahir, A. Şafak, and C. Meltem. The effect of environmental concern and scepticism on green purchase behaviour. *Marketing Intelligence & Planning*, vol. 31, pp. 27-39, 2013.
- [3] Azizan, S. A., & Suki, N. M. (2013). Consumers' Intention to Purchase Green Product: Insights from Malaysia. *World Applied Sciences Journal*, 22(8), 1129-1134.
- [4] Báo, T. H. (2015). *Critical Factors Affect Consumers' Purchase Intention towards Green Products in Ho Chi Minh City*.
- [5] B. F. Scott and J. David. Environmentally responsible purchase behaviour: a test of a consumer model. *European Journal of Marketing*, vol. 34, pp. 723-746, 2000.
- [6] B. S. Bodo, M. B. Greg, and D. Adamantios. The link between green purchasing decisions and measures of environmental consciousness. *European Journal of Marketing*, vol. 30, pp. 35-55, 1996.
- [7] D. S. Clare, T. Mehdi, and L. Peter. An empirical study on the influence of environmental labels on consumers. *Corporate Communications: An International Journal*, vol. 11, pp. 162-173, 2006.
- [8] D. S. Robert and A. R. James. Environmental segmentation alternatives: a look at green consumer behavior in the new millennium. *Journal of Consumer Marketing*, vol. 16, pp. 558-575, 1999.
- [9] D'Souza, C., Taghian, M., Lamb, P., & Peretiakos, R. (2006). Green Products. *Society and Business Preview*, 1(2), 144-157.
- [10] E. V. Bindah and M. N. Othman. An empirical study of the relationship between young adult consumers characterized by religiously-oriented family communication environment and materialism. *Cross-Cultural Communication*, vol. 8, p. 7, 2012.
- [11] J. A. Ottman. *Green marketing: opportunity for innovation* / Jacquelyn A. Ottman; foreword by William K. Reilly, 2nd ed. Lincolnwood, Ill. NTC Business Books, 1998.
- [12] Joshia, Y., & Rahmanb, Z. (2015). Factors Affecting Green Purchase Behaviour and Future Research. *International Strategic Management Review*, 3(1-2), 128-143.
- [13] J. T. Newsom, B. H. McFarland, M. S. Kaplan, N. Huguet, and B. Zani. The health consciousness myth: implications of the near independence of major health behaviors in the North American population. *Social Science & Medicine*, vol. 60, pp. 433-437, 2005.
- [14] I. Vermeir and W. Verbeke. Sustainable food consumption among young adults in Belgium: Theory of planned

- behaviour and the role of confidence and values. *Ecological Economics*, vol. 64, pp. 542-553, 2008.
- [15] Giang, N. T., & Tran, H. T. (2014). Understanding Vietnamese Consumers' Purchase Intentions toward Green Electronic Products in Hochiminh City. *First Asia-Pacific Conference on Global Business, Economics, Finance and Social Sciences*. Singapore.
- [16] G. Shruti and T. O. Denise. To buy or not to buy? A social dilemma perspective on green buying. *Journal of Consumer Marketing*, vol. 26, pp. 376-391, 2009.
- [17] Kong, W., Harun, A., Sulong, R. S., & Lily, J. (2014). The Influence of Consumers' Perception of Green Products on Green Purchase Intention. *International Journal of Asian Social Science*, 4(8), 924-939.
- [18] K. Sonderskov and C. Daugbjerg. The state and consumer confidence in eco-labeling: organic labeling in Denmark, Sweden, The United Kingdom and The United States. *Journal of the Agriculture, Food, and Human Values Society*, vol. 28, pp. 507-517, 2011.
- [19] Kumar, B. (2012). *Theory of Planned Behaviour Approach to Understand the Purchasing Behaviour for Environmentally Sustainable Products*. Indian Institute of Management, Ahmedabad.
- [20] Lee, Y. K., Kim, S. Y., Kim, M. S., & Choi, J. G. (2014). Antecedents and interrelationships of three types of pro-environmental behavior. *Journal of Business Research*, 67(10), 2097-2105.
- [21] M. Gleim, J. Smith, D. Andrews, and J. Cronin. Against the Green: A Multi-method Examination of the Barriers to Green Consumption. *Journal of Retailing*, vol. 89, pp. 44-61, 2013.
- [22] M. M. Mostafa. A hierarchical analysis of the green consciousness of the Egyptian consumer. *Psychology and Marketing*, vol. 24, pp. 445-473, 2007.
- [23] P. Shamdasani, G. Chonlin, and D. Richmond. Exploring green consumers in an oriental culture – Role of personal and marketing max factors. *Adv. Consum. Res.*, vol. 20, pp. 488-493, 1993.
- [24] Rashid, N. R. (2009). Awareness of Eco-label in Malaysia's Green Marketing Initiative. *International Journal of Business and Management*, 4(8), 132-141.
- [25] Robin A. Coulter, Linda L. Price, and L. Feick. Rethinking the Origins of Involvement and Brand Commitment: Insights from Postsocialist Central Europe. *Journal of Consumer Research*, vol. 30, pp. 151-169, 2003.
- [26] Straughan, R. D., & Roberts, J. A. (1999). Environmental Segmentation Alternatives: A Look at Green Consumer Behavior in The New Millennium. *Journal of Consumer Marketing*, 16(6), 558-575.
- [27] T. B. Chen and L. T. Chai. Attitude towards the environment and green products: consumers' perspective. *Management Science and Engineering*, vol. 4, p. 27, 2010.
- [28] T. Sarmidi and N. Salleh. Dynamic inter-relationship between trade, economic growth and tourism in Malaysia. *IDEAS Working Paper Series from RePEc*, 2010.
- [29] Y. Joshi and Z. Rahman. Factors Affecting Green Purchase Behaviour and Future Research Directions. *International Strategic Management Review*, vol. 3, pp. 128-143, 2015/06/01/ 2015.
- [30] Zia-ur-Rehman and M. K. B. Dost. Conceptualizing Green Purchase Intention in Emerging Markets: An Empirical Analysis on Pakistan. *The 2013 WEI International Academic Conference Proceedings*, 2013, pp. 99-120.

# Analysis of Factors Affecting The Income of Households Making GI Products: A Case Study of Ha Long Grilled Squid - Quang Ninh Province

Nguyen Van Thinh<sup>a\*</sup>

<sup>a</sup> TNU – University of Economics & Business Administration, Tan Thinh ward, Thai Nguyen city

## ABSTRACT

The research was conducted for the purpose of analysing factors affecting the income of households making geographical indication (GI) products. Specifically, the product selected for this analysis is Ha Long grilled squid. Results of the study showed that factors such as households' characteristics, natural conditions, etc. bear significant impact on households' income. Additionally, the higher sale price of Ha Long grilled squid compared to that of similar products without GI also contributed to the positive change of producers' income. On that basis, the author proposed some suggestions to improve the income of Ha Long grilled squid-making households in particular and those making GI products in general.

**Keywords:** household income, GI product-making household, Ha Long grilled squid

## 1. Introduction

In the context of international economic integration and climate change, the consumption trend of high quality agricultural products is advancing in both domestic and export markets not only in developed countries but also in those with developing economies.

Therefore, the development of safe agricultural production is an urgent issue set out today. Accordingly, clean production of GI products has become greatly critical to Vietnamese agriculture as it facilitates the entry of these special goods into the world's market, promoting the value and income of households.

Quang Ninh province is one of the localities in Vietnam that has the advantage to develop production and processing of GI products with the incentives that nature offers in terms of input materials, exploiting experience and processing traditions of local people. Actually, local certified GI products by the National Office of Intellectual Property, including Ha Long grilled squid, have proved positive impact on the overall economic progression of Quang Ninh province in particular and the whole country in general.

Therefore, in this research, certain measures are recommended with the hope to enhance the income of households making Ha Long grilled squid as well as those making GI products in Vietnam.

## 2. Literature review

GI and the effects of GI have recently been the concerns of not only researchers but also policymakers, particularly when the need to produce safe agricultural items is highly demanded. In the study, the author investigated the economic and social influence of GI, then pointed out the benefits associated with GI from the perspective of the market as well as of the production households based mostly on the sustainable livelihood framework of DFID (1999) as follows:

\* Nguyen Van Thinh. Tel: +84919910116  
Email:nguyenvanthinhftu@gmail.com

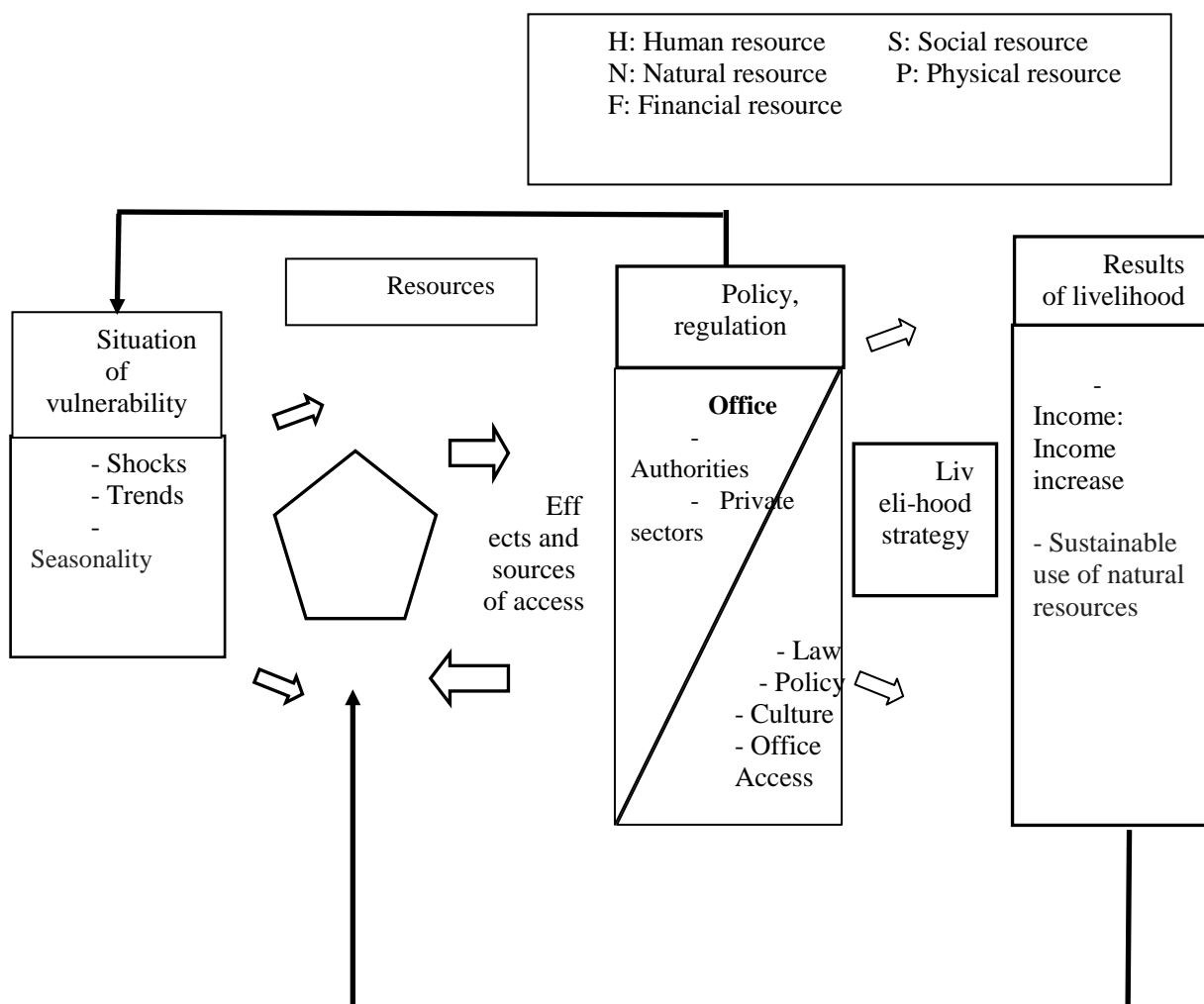

However, developing countries should note that the incentives for socio-economic advancement from GI products largely depend on the specific context. Focusing on product labelling scheme, Grote, Ulrike (2009) strongly indicated that the impact of GI is heterogeneous across countries, regions and sectors.

In addition, in the study by Dominique Barjolle et al. (2009), the author examined the methods of territorial impact assessment (economic, social and environmental) of GI systems. 14 GI products were chosen for comparison, which revealed that economic benefits are the sole motive for the implementation of GI product protection schemes. In the same field, Carina Folkesson (2005) also showed the concern of GI in terms of basic and professional concepts. Accordingly, GI is defined to belong to collective ownership, deriving from a particular geographic area. GI product-makers must ensure that the items carry sufficient features of and are made from the substance of that geographic region.

India was the locality chosen by the researchers Pradyot R. Jena, Ulrike Grot, (2010). The research contributes to the clarification of the theoretical issues related to GI in two aspects: (1) GI is one of the first empirical papers providing the evidence for a GI product; (2) GI products contribute to the increase of household welfare. To collect data for the study, the author conducted a survey of 300 rice farmers in a northern Indian province, Uttarakhand. Households were selected for interviews by stratified random sampling method, including both rice farmers following GI product standards and growers of other crops in the same region without GI certification. The results showed that Basmati rice is more profitable than other crops. Subsequently, main factors affecting the decision to produce GI products are mentioned, including the ability to access government policy and the skill of labor in each household, etc.

The economic impact of GI has also been theoretically recognized by various researchers (Moschini et al. (2008)). GI products are made in a geographical area with exclusive climatic and geographic features, with the use of traditional skills, thus, they become unique, enjoy premium quality and high market price. Another evidence of GI product market in developing countries can be found in a research by Suh et al. (2007). The case study on Boseong green tea in Korea of this author showed that within just six years, the image of the product became much closer to consumers, leading to production increase and more specially, the number of tourists to the Boseong area also tripled. The income from producing and processing GI tea escalated significantly, with market price rising over 90 percent compared to the day without GI.

In Vietnam, GI and GI products are relatively new concepts both in theory and practice. Although a number of



scientific studies on this issue have been piloted, the major approach is state management of intellectual property. In the research paper by Vu Hai Yen (2008), GI is mostly coached from legal perspective, focalizing on the legal establishment and protection of GI. Concerning GI from commercial aspect, Le Thi Thu Ha (2010) considered Vietnam's GI in the context of international economic integration.

### **3. Research method**

#### **3.1. Data collection method**

##### 3.1.1. Secondary information

Secondary information on the income of GI product – making households is collected from documents officially issued by Quang Ninh's Department of Industry and Trade, Department of Agriculture and Rural Development, Department of Science and Technology, People's Committee of Ha Long City - Quang Ninh province, etc.

##### 3.1.2. Primary information

Primary information is collected by interviewing households with standardized questionnaires. Questionnaire is developed based on the questionnaire of the General Statistics Office (GSO) 2016 and the content on household living standards to make a suitable survey in accordance with the research topic.

The author conducted a survey with 30 households specializing in exploitation, production and processing of Ha Long grilled squid in Quang Ninh province.

The process of collecting primary information is as follows:

+) District /city level: Representative areas of GI grilled squid in Ha Long City, Quang Ninh Province are chosen.

+) Commune level:

6 communes/wards in which 3 communes/ wards have households specializing in producing, trading, exploiting and processing GI products and 3 others have households producing, exploiting, trading and processing similar products without GI. Subsequently, in each commune/ward, 5 households are randomly selected to attend interview.

A combination of income-related information collecting and factor analyzing is employed.

#### **3.2. Information analysis method**

##### 3.2.1. Descriptive statistics method

To evaluate the factors affecting the livelihood of GI product-making households in Quang Ninh, the author employed both qualitative and quantitative method. These two methods worked together and positively supported each other in clarifying statements or drawing conclusions of the research problem. The data for the research and evaluation was taken from both primary and secondary sources.

##### 3.2.2. Regression model

Data collected from sample surveys is to be encrypted and imported into Excel. Data processed with the help of SPSS 20 was used for the construction of multivariate regression model to determine the impacts of these factors on the income of producers, from which causes and solutions for increasing households' income were figured out.

##### 3.2.3. Testing the difference

The author used T-test, Anova to test the difference in the impact of factors on the income of producers of GI products and producers of products without GI.

### **4. Research results**

#### **4.1. Actual income of households making Ha Long grilled squid**

By the end of 2016, Ha Long City had 30 units producing Ha Long grilled squid (23 of which are in Ha Long I market and 7 are in Ha Long II market) and some non-professional processing bunches. The production of this GI product has made a denoting contribution towards household income and job creation for local people. (Source of information: People's Committee of Ha Long City).

Although the processing technology has recently been boosted, processing facilities still use some traditional techniques to ensure the typical quality the product.

The income of surveyed households in the period 2014-2016 is as follows:

**Table 1: Average income of households making Ha Long grilled squid**

Unit: Million VND/year

Year	2014	2015	2016
Each household's average income /year	342.6	363.58	392.95
Comparison	-	21.42	29.37

(Source: Author's survey)

The result showed that the income of these households increased gradually during the studied period thanks to GI certification by the National Office of Intellectual Property. However, the income is "seasonal" and strictly dependent on input materials and exploitation time of "Nang cuttlefish".

Compared to the income of producers making grilled squid without GI in the region, significant difference can be noticed.

**Table 2: Average income of households in Ha Long making grilled squid with and without GI**

Unit: Million VND/year

Criterion	With GI	Without GI
Household's average income/year	392.95	232.35

(Source: Author's survey)

As can be seen in Table 2, the average annual income of households making GI grilled squid is twice as much as that of those making similar products without GI. This situation is believed to be the result of high market price and consumption volume of Ha Long grilled squid.

#### 4.2. Factors affecting the income of households making GI products

##### 4.2.1. Selling price

The selling price of Ha Long grilled squid is relatively higher than similar squid products without GI in Quang Ninh province. To be specific:

**Table 3: Selling price of grilled squid from different places in Quang Ninh**

No.	Name of product	Selling price (1000VND/kg)	Place of supply
1	Ha Long grilled squid	360-380	Ha Long, Quang Ninh
2	Van Don grilled squid	300-320	Van Don, Quang Ninh
3	Hai Ha grilled squid	240-300	Hai Ha, Quang Ninh
4	Quang Yen grilled squid	140-200	Quang Yen, Quang Ninh

(Source: People's Committee of Quang Ninh Province)

The results of Table 3 demonstrated noticeable benefits generated thanks to the production and processing of Ha Long grilled squid. In terms of commerce, the market price of grilled squid vary area by area, with higher price this GI product is twice as high as that of similar item without GI.

In fact, to achieve the above status, Ha Long grilled squid products have to follow such strict production process (the strict 12-step provision from material, hygiene to packaging). By well meeting those requirements, Ha Long grilled squid firmly wins consumer satisfaction so that they are willing to pay for it.

##### 4.2.2. Processing and production conditions

Table 4 shows that the impact of the transport system (TS) and nature incentives (NI) is expected to be higher by makers of GI products. The author's calculation also matched with this assessment. Understandably, unfavourable factors from nature like climate change or tidal condition may adversely induce the production and processing of grilled squid, which subsequently negatively influences the income of households.

Specifically, the assessing point of GI product makers for nature incentive criterion is 4.07, whereas that of producers of goods without GI is around 3.93. The same picture exists for the criterion of transport system.

**Table 4: Mean value of the scale of condition for Ha Long grilled squid**

Group Statistics					
	IG	N	Mean	Std. Deviation	Std. Error Mean
TS	1	15	4,20	,775	,200
	0	15	3,80	1,082	,279
NI	1	15	4,07	,704	,182
	0	15	3,93	,961	,248

(Source: Author's calculation)

**Table 5: Testing the Mean difference**

Independent Samples Test										
		Levene's Test for Equality of Variances		t-test for Equality of Means						
		F	Sig.	t	Df	Sig. (2-tailed)	Mean Difference	Std. Error Difference	95% Confidence Interval of the Difference	
								Lower		Upper
TS	Equal variances assumed	2.361	.136	1.164	28	.254	.400	.344	-304	1.104
	Equal variances not assumed			1.164	25.361	.255	.400	.344	-307	1.107
NI	Equal variances assumed	1.839	.186	.433	28	.668	.133	.308	-497	.763
	Equal variances not assumed			.433	25.660	.668	.133	.308	-499	.766

(Source: Author's calculation)

When the average of the two target groups as well as the transport and nature incentive factors is compared, there is no difference in the overall average score of these two groups with a significance level of 5% (TS has Sig = 0.254 > 0.05 and NI has Sig. = 0.668 > 0.05).

It can be ascertained that under the conditions of exploitation and processing, GI product makers have a higher mean value but there exists no significant difference between the two surveyed groups of households regarding transport system. This may be due to the fact that the exploitation and processing of squid products (whether with or without GI) in the province have been supported by standardized transport conditions.

As for the nature incentive factor, the preference in climate or weather for the input materials appears the same among squid producers in Quang Ninh, but seems to be more concerned for Ha Long grilled squid. It is understandable that GI producers have a more sensitive assessment on nature incentive than their counterpart thanks to their perception of seasonal factors which helps them avoid bad weather conditions affecting the quantity and quality of products.

4.2.3. Characteristics of producers

The average labour (AL) in households making GI products is 2.87 and the average age of the head of household (A) is 45.33, whereas the former of the other group is 2.73 and the latter is 44.33 years old. The year of experience (YE) of the first group is 9.2 while that of the other group is only 6.87.

**Table 6: Mean value of scales of producers' characteristics**

Group Statistics					
	IG	N	Mean	Std. Deviation	Std. Error Mean
AL	1	15	2,87	,743	,192
	0	15	2,73	,704	,182
YE	1	15	9,20	2,455	,634
	0	15	6,87	1,685	,435
A	1	15	45,33	6,377	1,647
	0	15	44,33	11,908	3,075

(Source: Author's calculation)

**Table 7: Verification of mean difference of scales of household characteristics**

	Levene's Test for Equality of Variances		t-test for Equality of Means						
	F	Sig.	T	Df	Sig. (2- tailed)	Mean Difference	Std. Error Difference	95% Confidence Interval of the Difference	
								Lower	Upper
L	.004	.952	.505	28	.618	.133	.264	-.408	.675
			.505	27.917	.618	.133	.264	-.408	.675
E	2.161	.153	3.035	28	.005	2.333	.769	.758	3.908
			3.035	24.790	.006	2.333	.769	.749	3.917
	5.771	.023	.287	28	.776	1.000	3.488	-6.145	8.145
			.287	21.419	.777	1.000	3.488	-6.245	8.245

(Source: Author's calculation)

When comparing the average of labour number between the two groups by using F-test, the result has  $sig. = 0.952 > 0.05$ , therefore T – test is used in the Equal variances assumed section and the age of the head of household has  $Sig. (Test F) = 0.023 < 0.05$ , so we use the T – test in Equal variances not assumed in order to test the difference. As a result, we see no mean difference between AL and A of these two groups with a significance level of 5% (AL has  $Sig. (T test) = 0.618 > 0.05$  and A has  $Sig. (T test) = 0.777 > 0.05$ ). As for the experience of the head of household (YE), the mean value of the makers of GI products is 2.333 years with a significance level of 5% ( $Sig. (F test) = 0.153 > 0.05$  and  $Sig. (T-test Equal variances assumed) = 0.005 < 0.05$ ) greater than that of the other.

Based on the surveyed data, it can be concluded that there is no difference regarding the age of the head of household and labour number between the producers of GI items and those of products without GI. In terms of experience, it can be seen that the greater experience the heads of households have, the more likely they are involved in producing GI products.

## 5. Discussions and Recommendations

In order to promote the income of GI product-making households, following measures to be considered:

Firstly, improving the quality of labour producing GI products, including skills and production experience, is increasingly vital. This plays an extremely important role in deciding the quality of GI products due to the particular features as well as the requirements for typical processing and production.

Secondly, ensuring the source of input materials becomes more and more essential because of its direct impact on the product quality. It is undeniable that proper materials mostly guarantee premium products. Well meeting the market demand promises a stable and surge in the income of GI product makers. In the context of severe climate change and shortage of sea resources, new sources and types of materials are to be found so that the production of GI products could survive.

Thirdly, the exploitation and processing of Ha Long squid should be conducted appropriately as it is hugely influenced by climatic factors and natural conditions. If the exploitation cannot meet the sustainability, it will alter input materials. On that account, product quality may curtail, resulting in market fall and income contraction of producers.

Fourthly, it is crucial to closely monitor the quality to ensure the prestige of Ha Long brand for squid products, which has a direct impact on production households. Actually, the floating fake and defected products on the market somehow affect badly the image of GI genuine items as well as the customer loyalty.

Last but not least, expanding consumption market for Ha Long squid seems potential measure, especially to countries and regions without sea like Laos, Nepal and or those with different oceanic conditions in other continents. Besides, a link with the non-smoke industry – tourism of the province may promise a flourish thanks to the promotion of GI product trading.

## References

- [1] Cerkia Bramley (2011), A review of the socio- economic impact of GI: considerations for the developing worlds, WIPO worldwide symposium on Geographical Indications Conference, June, Peru;
- [2] Carina Folkesson (2005), Geographical Indications and Rural Development in the EU, School of economics and management, Lund University;
- [3] Dominique BARJOLLE, Marguerite PAUS, Anna PERRET (2009), Impacts of Geographical Indications - Review of Methods and Empirical Evidence, International Association of Agricultural Economists Conference, Beijing, China;
- [4] Grote, Ulrike (2009), Environmental Labeling, Protected Geographical Indications and the Interests of Developing Countries, The Estey Centre Journal of International Law and Trade Policy, Volume 9, Number 2, 138-154;
- [5] Moschini, G., L. Menapace, and D. Pick (2008), Geographical Indications and the Competitive Provision of Quality in Agricultural Markets, American Journal of Agricultural Economics, 90(3) 794-812;
- [6] Lê Thị Thu Hà (2010), Bảo hộ quyền sở hữu công nghiệp dưới góc độ thương mại đối với chỉ dẫn địa lý của Việt Nam trong điều kiện hội nhập kinh tế quốc tế, Luận án tiến sĩ kinh tế, Đại học Ngoại thương;
- [7] Pradyot R. Jena, Ulrike Grot (2010), Does Geographical Indication increase producer welfare? A case study of Basmati rice in Northern India, ISEE conference;
- [8] Suh, Jeongwook, and Alan MacPherson (2007), The impact of Geographical Indication on the revitalization of a regional economy: a case study of 'Boseong' green tea, Area 39(4): 518-527;
- [9] Vũ Thị Hải Yến (2008), Bảo hộ chỉ dẫn địa lý ở Việt Nam trong điều kiện hội nhập kinh tế quốc tế, Luận án tiến sĩ luật học, Đại học Luật Hà Nội.

International Conference For Young Researchers In Economics And Business, ICYREB 2017, October 30<sup>th</sup> 2017  
Da Nang, Vietnam

# Interface between Competition Law and Intellectual Property Law in the Enforcement of Intellectual Property Right in Vietnam

Bui Thi Hang Nga\*, Huynh Van Hung, Le Thi Diem

## ABSTRACT

In fact, it is often argued that there will always be a conflict between competition law and intellectual property law (IP law). The reason for this argument is that while competition law aims to remove monopoly from the market, IP law gives the owner the exclusive right to exploit intellectual property. However, from the practice of enforcement of competition law and IP law, many researchers admitted that there is an interface between competition and IP law because they have common purposes of promoting innovation and bringing consumer benefits.

The paper aims to analyze this interface in Vietnam legal system.

**Keywords:** The interface, Competition Law, Intellectual property law.

## 1. Introduction

Deriving from the purpose and applicable object of competition law and IP law, it is argued that there be a conflict between competition law and IP law. The reason for this argument is that while competition law aims to remove monopoly on the market, IP law gives the owner the exclusive right to exploit intellectual property to reward their innovation, encourage and promote creative and research activities.

Experiencing the enforcement in practice, many researchers admitted that there is an interface between competition law and IP law, which is the common purpose of promoting innovation, creativity and brings consumers benefits.

American Court System also admitted that “though the approach of competition law and IP law at the beginning seem to be completely opposite, actually they have common nature and purpose which aims to promote innovation, economic development and competition [1]”. Therefore, competition law and IP law should have interacted regulations to restrain the monopoly deriving from intellectual property rights and exceptions to protect certain benefit of this monopoly at the same time. Those regulations aim to balance of owner’s profits and the accessing right to patents and other IPRs of society. The interface has been based on some theories:

- The leverage theory

According to Kaplow [2], the owners who own patents will gain more competitive advantage than competitors, and they will use those patents as the tools to gain monopoly power, not only on the market for their products but also on another relevant market. Therefore, the owners tend to refuse to license for competitors to maintain their advantage on the market. However, it would lead to the fact that consumers or nations are unable to access to technology of new products and thus, distort relevant competition environment.

- The Essential Facilities Doctrine

The essential facilities doctrine is developed from the leverage theory but with analysis of certain specific subjects. Accordingly, an enterprise having market power because of owning an essential facility as facility or IP rights as the entry prerequisite to a market will prevent a rival from entering into such market by refusing to license or grant access to its own facility/IP rights with the purpose of extending their market power in other relevant markets. Under this doctrine, in some cases, that entrepreneur will be forced to provide access to those facilities with a reasonable price [3] to remove the harmful monopoly of owner to competition by laws. This doctrine has stipulated in U.S., EU, and Australia laws as a method to prevent from extending the monopoly with various requirements on proof.

\* Corresponding author. Tel.: +84 966002209.  
E-mail address: ngabth@uel.edu.vn

- The competitive advantage theory

For an enterprise, owning new technology or patent will enable itself with a competitive advantage on the market. Considering significant benefit from market power, the owner may abuse monopoly on IP created and protected by IP rights to harm competition environment.

- Besides, a distinct theory on the effect of competitive restriction is cost increasing for competitors [4]. Accordingly, the enterprise having competitive advantage may use IP rights to create market-entry-barriers and increase the costs of their competitors. As a result, they will be able to increase their prices profitably and exercise market power through the output or to undercut their prices profitably and make their competitors be out of the market. Through it, they acquire the market. IP rights could make the strategy of cost increases for rivals more easily if technology created by the IP rights is valuable.

With above theories, we can see that the exclusion created by IP rights is not the exception to competition law by default. Therefore, the policies, principles of competition law which applied in enforcing IP rights may be transparent or not, we are sure that they are two sides of the legal system.

Therefore, normally, in a national legal system, we could not build the competitive advantage for enterprises and protect competition environment effectively without competition law and IP law. However, depending on various approaching, establishing and enforcing the law, this interface shall be expressed in different levels to make law enforcement effectively.

## 2. The Interface between Competition Law and Intellectual Property Law in Vietnam

It is clear that the recognition of intellectual property rights and owners' rights toward intellectual property is significant because it not only promotes innovation activities but also improves people's quality of life and contributes to economic development.

Therefore, IP law is an important part of the legal system. Investment and creative activities will be only stimulated effectively if legal regulations are suitable and efficient.

In Vietnam, the first legal document expresses the state protection relating to intellectual property was Decree No. 197/HĐBT on 14/12/1982 of Council of Ministers promulgating rules on goods trademark. That was the first time that a legal document stipulates specific regulations on subjects, conditions, and procedure to protect a trademark, also the right of owners of protected trademark, even the exclusive right to use.

*"Any individual or organization who uses the trademark of others without allowance of the owner or uses the similar elements may mislead consumers with other trademarks of goods had been listed, are considered to violate the exclusive using right of the trademark owner."* [5]

Together with the development of innovation and the market economy, the role of intellectual property ownership is more and more important to economic, political and social development. It requires that legal system must have the compatible regulations to create a protection mechanism and protect rights of the relevant subjects. The Vietnam Constitution which was promulgated in 1992 (amended in 2001) had confirmed that the citizen has rights to invest in creative activities and to be protected of the results from those creative activities:

*"Citizens have the right to conduct scientific and technological research, inventions, innovations, technical innovations, production rationalization, literary and artistic production and criticism, and participation in other cultural activities. The State protects copyright and industrial property rights"*. [6]

To specify this regulation, the Civil Code 1995 provides a whole section (Section 6) to regulate on intellectual property. With 81 articles (from Article 745 to Article 825), the Civil Code 1995 stipulates specific regulations relating to copyright, industrial property right, and technology transfer. Besides that, Decree No. 63/CP on 26/10/1996 regulated on industrial property and Decree No. 12/1999/NĐ-CP on 08/3/1999 regulated on administrative sanctions for industrial property violations have been enacted to implement. Together with the establishment of state management agency on intellectual property (National Office of Industrial Property in 1993 and National Office of Intellectual Property in 2003 [7]) with specific duties, the protection of IP rights in Vietnam had been enforced effectively at the beginning.

However, the turning point in law and enforcement of IP rights in Vietnam was the Bilateral Trade Agreement (BTA) between Vietnam and The United States in 2000. The BTA has specific regulations to bind the engagement of Vietnam Government in enforcing TRIPs Agreement of WTO effectively. These engagements implemented IP rights in Vietnam more efficiently with the issuance of new legal documents in this area.

In 2005, Vietnam promulgated the new Civil Code and stressed the general civil principle of IP rights (section VI) once again. At the same time, Intellectual Property Law was issued (in 2005, amended in 2009) regulated all aspects of IP rights. These documents have established a uniform legal system to address various issues relating to intellectual property in Vietnam.

With the specific and appropriate regulations, IP law 2005 creates an effective regulating regime. In industrial property section, specifically, IP law regulates protection scope of the state toward subjects that satisfy the conditions in law. Specified:

- Protection title and validity of protection titles

A protection title shall recognize the owner of the invention, industrial design, layout-design or mark (from now

on all referred to as protection title holders); the author of the invention, industrial design or layout-design; and the subject matter, scope and term of protection [8].

“1. Protection titles shall be valid throughout the entire territory of Vietnam.

2. An invention patent shall be valid from the grant date until the end of twenty years after the filing date.

3. A utility solution patent shall be valid from the grant date until the end of ten years after the filing date.

4. An industrial design patent shall be valid from the grant date until the end of five years after the filing date and may be renewed for two consecutive terms, each of five years.

5. A certificate of registered design of semi-conducting closed circuits shall be valid from the grant date until the earliest date among the following:

(a) The end of ten years after the filing date;

(b) The end of ten years after the date the layout design was first commercially exploited anywhere in the world by a person with the registration right or his or her licensee;

(c) The end of fifteen years after the date of creation of the layout design.

6. A certificate of a registered mark shall be valid from the grant date until the end of ten (10) years after the filing date and may be renewed for many consecutive terms, each of ten (10) years.

7. A certificate of registered geographical indication shall be valid indefinite from the date of grant” [9].

• The owner rights

Owners of industrial property objects shall have the following economic rights:

“a) To use or authorize others to use industrial property objects according to the provisions of article 124 and Chapter X of this Law;

b) To prevent others from using industrial property objects according to the provisions of article 125 of this Law;

c) To dispose of industrial property objects according to the provisions of chapter X of this Law.” [10]

By promulgating the regulations mentioned above, IP law recognizes that the owner has the exclusive rights on exploitation and prevents other subjects from violating to protected rights.

It also enables the owner to create a competitive advantage, giving a market power toward someone who wants to approach the intellectual property, while market power is a governing subject of competition law. This is the reason why the researchers believe that it is necessary to use the regulations of competition law to intervene the IP relations. Accordingly, the exercising of IP rights must not violate the state benefits, social benefits, rights, and advantages of other subjects and must not violate other regulations of relevant laws. [11]

Therefore, the law in its content is not only to protect exclusive rights of the owner but also to protect benefits of the state, society, and consumers. It means that laws must balance self-benefits of the owner with common benefits of society in overall. In case the social benefits are more than owner benefits, the law must protect the social benefits. This causes exceptions of owner’s exclusive rights. In particular cases, the law prohibits or restrains the owners to exercise their rights, or the owner must allow other organizations or individuals to use their rights [12]. Thus, in a relationship with competition law, the owner’s exclusive rights may be broken in some special cases. Among these particular cases is when owner conducts prohibited practices to restraint of competition. However, IP law does not specifically define what “practices in restraint of competition”<sup>†</sup> is. In practice, the implementation of owner rights is more likely to make arising, in some cases, a restriction on competition if the owner abuses the competitive advantage derived from the holding of the intellectual property<sup>‡</sup> with the unbridled power of monopoly, market power, and super-profits.

Vietnam Competition Law, issued in 2004 and effective in July 2005, is applicable to organizations and individuals conducting business (hereinafter referred to as enterprises), including enterprises engaged in production or supply public utility products or services, enterprises conducting business in State monopoly industries and sectors and overseas enterprises operating in Vietnam; Industry associations operating in Vietnam [13]. Competition Law governs practices in restraining competition, unfair competitive practices, procedures for resolution of competition cases, and measures for dealing with breaches of the Competition Law [14].

In comparison with the provisions of IP law, it can be seen that practices in restraint of competition relating to IP rights have yet been stipulated and governed by Competition Law and IP law.

Practices in restraining competition mean practices of enterprises which reduce, distort or hinder competition on the market, including practices being agreements in restraining competition, abuse of dominant market position, abuse of monopoly position and economic concentration [15]. They are divided into three groups of specific behavior:

- Agreements to restrain competition substantially (article 8);
- Abusing dominant position or monopoly position (article 13 and 14);
- Economic concentration causing restraint of competition (article 18);

Thus, in relation to competition law, practices in restraining competition which exercised by IP owner (if any) is the relationship between general law and specialize law which regulates the practices in restraint of competition on the market. Besides, in cases of having differences between regulation of Competition Law and other law on practices in

<sup>†</sup> Competition Law specifically regulates only the unfair competitive practices in article 130.

<sup>‡</sup> “Industrial property rights mean rights of an organization or individual to inventions, industrial designs, designs of semi-conducting closed circuits, trade secrets, marks, trade names and geographical indications which such organization or individual created or owns, and the right to prevent unfair competition” (Article 4.4 Law on Intellectual Property)



restraint of competition and unfair competition, Competition Law shall be applied. [16]

Therefore, in relation to competition law, the implementation of IP rights must comply with regulations of competition law to ensure a fair competition environment. However, it could not remove the exclusive right of the intellectual property owner.

However, in practice, there is no simultaneous connection between these two laws which leads to uncompleted regulations, low effective implementation [17]. It is not only regarding enforcement authorities but also insufficient regulations. In approaching competition law, the IP right in general and industrial property right in particular are among the factors constituting the restraint of competition significantly for right-holding enterprises<sup>5</sup>. It means that the exercise of IP rights by the owner could lead to the restraint of competition law when the market share is 30% or more, regardless of the natural rights of the owner which is recognized by intellectual property law. A typical example is the practice of refusal to transfer the intellectual property rights and the practice of tying in the transferring contract.

Refusal to transfer IP right is that the owner of IP rights refuses to allow other subjects to use his rights. Currently, under the regulation of Competition Law, if an enterprise holding IP rights and having the dominant position on the market (at least 30% market share) refuses to transfer, it is considered a violation of competition law. In another way, refusal to transfer IP rights shall be regarded as a breach of competition law when the enterprise has market share which equivalents to 30% or more. This shall affect innovation and creative activities of other subjects negatively because one of the factors that create the exclusive rights of the owner is free to choose a business partner and dispose of its assets. Thus, to consider the impact of the refusal to transfer, we must take into account two aspects: (i) its impact on the competitive market (in the view of competition law); (ii) its impact on innovation and creative activities (in the opinion of IP law). Therefore, to balance the benefits of subjects, it is necessary to consider the restraint of competition arising from the refusal to transfer in the principle of equitable balance rather than the principle of default violation as the approach of current competition law. Vietnam should learn from experiences of the United States and EU when considers the refusal to transfer intellectual property rights in relation to competition law, in way of recognizing the refusal to transfer as a basic right of holding subjects and the exercise of this right should be only considered as a violation when it negatively affects to competition environment, distorts the market and affects the innovation and creative activities as well as the interests of consumers in general through the following signals:

- The practice of right holder composes the refusal to transfer;
- The right holder has the dominant position in the relevant market;
- Intellectual property right is necessary to conduct the economic practices in the secondary market;
- Refusal to transfer may distort the secondary market;
- Refusal to transfer without reasonable reason and responsibility requirement does not negatively affect to innovation incentive.

- Refusal to transfer prevents the emergence of new products that potential customers have the demand, or compulsory transfer is essential for subsequent innovation activities [18].

Similarly, the practices of tying in transfers are reasonable when the primary product and the joint-demand product could not separate into a technology package. If these two products are linked vertically, this product is input to produce the other product, or two products are connected to make product quality or uniformity of technology chain, so the tying agreement is necessary to maintain or increase the reputation of quality, the reliability of goods, services and the completeness of technology. Therefore, in this case, the laws should admit that the tying agreement is necessary. On the contrary, in case the licensor abuses the tying agreement to acquire a dominant position on the market, affect to competitive environment negatively, that tying agreement must be prohibited.

Thus, it is unfeasible if it only based on the market share or the external manifestation of tying agreement (in cases for exemption) as in the current approach of Competition Law 2004 to consider approval or disapproval for any tying agreements. Approval or disapproval the tying agreement (full transfer) should depend on each specific case with analysis and impact assessment of these agreements in relation to benefits which these agreements provide.

Therefore, it is necessary for the law to provide principles, factors to consider, decide which tying agreement case shall be approved, which case shall be disapproved in the interface of IP rights and competition law. Specifically, Vietnam Competition Authority (VCA) shall determine which agreement violates the law or be prohibited by the law or not belong to competency of VCA as same as the U.S. or Europe law.

Accordingly, in a relationship with IP law, competition law of U.S. and Europe only prohibits one tying agreement if it satisfies all five following elements:

- Primary product and joint-demand product are particular products from consumers' side;

<sup>5</sup> The capability of an enterprise to significantly restrict competition on a relevant market shall be determined on one or some of the following major grounds:

1. Financial capability of the enterprise.

[...]

5. Technological capability.

**6. The right to own or use industrial property objects.**

7. The scope of the distribution network.

(Article 22 Decree No. 116/2005/NĐ-CP regulates in implementation of Competition Law 2004)

- The enterprise having tying agreement has the dominant position on the market;
- Through practices of tying agreement, that enterprise does not allow customers to buy the primary product without tying product;
- The practices of tying restrain competition;
- The practices of tying could not be demonstrated reasonably [19].

### 3. Conclusion

From the above analysis, it is clear that the current Vietnam laws have not yet created a systematic approach to the interface between competition law and IP law. In the perspective of competition law enforcement, the monopoly aspect derived from the holding of intellectual property rights has not been considered and emphasized. Because of this, the rights of owners in the process of implementing and exploiting their inventions are affected greater or less degree. In addition to the lack of simultaneous connection in terms of content, the enforcement between the two legal documents is less efficient [20]. Under current practices, state management agencies who enforce IP rights and competition policy belong to different authorities, while there is no effective coordinative mechanism between the competition and the intellectual property authority. On the other hand, it has been proven that the use of competition law provisions to assess the consequences of competition restriction related to the enforcement of intellectual property rights must be considered in many respects according to the principle of reasonable balance [21]. Therefore, to enforce the laws effectively, it is critical for the coordination between relevant authorities.

Therefore, in our legal system, it is necessary to have a legal basis that in some cases, competition law must recognize the legitimate existence and forming of monopoly which acquired from intellectual property rights. It means that, in such case, with particularities of intellectual property rights, competition law must recognize the owner's monopoly in the exploitation and using as well as allowing or preventing other subjects to exploit and use his intellectual property rights, even imposing conditions and exclusive terms in transferring contracts of intellectual property rights by the exceptional provisions of practices in restraint of competition.

This exception can be expressed through the criteria to consider competition restriction of the enforcement of intellectual property rights not only on the basis of market share or possibly through terms of the exemption for the enforcement of intellectual property rights.

In addition, the coordinative mechanism between the competition administration authority and the intellectual property management authority must be developed. The coordination mechanism should be considered and elaborated in many aspects from the development and improvement of the related legal provisions to eliminate conflicts/overlaps and have coordination in exchange of information and handling relevant violations.

### References

- [1] Department Of Justice, Antitrust and Intellectual Property, January 24, 2003, p2.
- [2] Louis Kaplow (1985), Extension of Monopoly Power Through Leverage, *Colombia Law Review*, vol.85: 515
- [3] Sally Van Sieten (1996), The Essential Facilities Concept, OECD
- [4] Ioannis Lianos & Rochelle C. Dreyfuss (2013), New Challenges in the Intersection of Intellectual Property Rights with Competition Law - A View from Europe and the United States, Centre for Law, Economics and Society.
- [5] Article 15.1 of Decree 197/HĐBT
- [6] Article 60 Vietnam Constitutions 1992
- [7] Information has been published at [http://www.noip.gov.vn/web/noip/home/vn?proxyUrl=/noip/cms\\_vn.nsf/\(agntDisplayContent\)?OpenAgent&UNID=F6949987893448544725764E004F5CA8](http://www.noip.gov.vn/web/noip/home/vn?proxyUrl=/noip/cms_vn.nsf/(agntDisplayContent)?OpenAgent&UNID=F6949987893448544725764E004F5CA8) viewed at 4p.m. on 16/4/2017
- [8] Article 92.1 of Law on Intellectual Property
- [9] Article 93 of Law on Intellectual Property
- [10] Article 123.1 of Vietnam Law on Intellectual Property 2005
- [11] Article 7.2 of Law on Intellectual Property
- [12] Article 3.4 and Article 10 of Civil Code 2015; Article 8.1 Law on Intellectual Property
- [13] Article 2 of Competition Law
- [14] Article 1 of Competition Law
- [15] Article 3.3 of Competition Law
- [16] Article 5.1 of Competition Law
- [17] Vietnam Competition Authority (2014), Report in revising competition law with specialized law, pp.53.
- [18] Kosef Drexl (2008), Research Handbook on Intellectual Property and Competition Law, Published by Edward Elgar, pp.232.
- [19] Nguyen Thanh Tu (2010), *Phap luat canh tranh chuyen giao cong nghe va hiep dinh TRIPs-Kinh Nghiem cho Viet Nam*, National Politics Publish House, pp.189.
- [20] Vietnam Competition Authority (2014), Report in revising competition law with specialized law, pp.53.
- [21] Hang Nga (2009), Agreement in Restraint of Competition in Franchising Contract, pp.21.

International Conference For Young Researchers In Economics And Business, ICYREB 2017, October 30<sup>th</sup> 2017  
Da Nang, Vietnam

# The Forth Industrial Revolution: Opportunities and Challenges Posing For 4 and 5-Star Rated Hotels in Vietnam

Hoang Thi Thu Trang\*

Hospitality and Tourism Faculty, Thuongmai University, 79 Ho Tung Mau, Mai Dich, Cau Giay, Hanoi, VietNam

## ABSTRACT

The birth of Industry 4.0 has constantly created a great influence on all industries. The manufacturer is under pressure to roboticism challenge while the service sectors has seen certain potentials. In that context, the hospitality industry in general and 4-5 star hotels in Vietnam in particular have potential for growth but still face several challenges. However, statistics show that more than 15% of 4-5 star hotels say that Industry 4.0 has no impact on their business and takes no action to adapt to the new environment. By using the secondary data, this article aims at pointing out the positive and negative impacts of Industry 4.0 that help 4-5 star hotels in Vietnam recognize the opportunities and challenges in the context of Industry 4.0, by which they will prepare based on their current business status and resources to succeed in the future.

**Keywords:** Industry 4.0, opportunities, challenges, 4-5 star hotels, Vietnam

## 1. Overall

Professor Klaus Schwab, Founder and Executive Chairman of the World Economic Forum, has given a simple view on the Forth Industrial Revolution (known as Industry 4.0). In the first industrial revolution, through using water and steam power, production is mechanized. In the second industrial revolution, production equipment changed to electrical power. The third industrial revolution saw a high level of automation through the increased proliferation of digital logic circuits and microprocessors. And the forth industrial revolution is rising from the third, which is the coming together of cyber networks with physical networks to create an autonomous system.

Industry 4.0 has already been changing the global manufacturing, and in Vietnam, some enterprises has been subjected to its effect. A survey conducted by VET recently on more than 2,000 SMEs that are members of the Vietnam Association of Small and Medium Enterprises, found that 85 per cent expressed concern with Industry 4.0. Of these, 55 per cent believed it would have a significant effect on Vietnam's economy, 23 per cent believed its impact would be moderate, 11 per cent believed it would have no major influence, 10 per cent said it would have no impact, and the remaining 6 per cent had no idea [10].

In terms of strategy, it is notable that up to 79 per cent of respondents said they haven't done anything to prepare for Industry 4.0. Fifty-five per cent said they have been seeking information or conducting research, while 19 per cent have set up plans and only 12 per cent have actually been implementing strategies. As it shows, only 31 per cent have made the move to grab the opportunities and prepare for challenges from Industry 4.0. Sixty-seven per cent of respondents believed they would not be overly affected by Industry 4.0, 56 per cent believed their business sector would not be overly impacted, and 76 per cent said they didn't understand the nature of Industry 4.0. More than a half (54 per cent), said they didn't believe they needed to care about it [10].

Because Industry 4.0 is a transformation, not a overnight change, Vietnamese enterprises in general and enterprises in hospitality in particular should actively prepare their resources. Hospitality industry in Vietnam is a blooming industry, which has seen a rapid growth in the recent years through the strong increase in the number of hotels ranging from small-scale to large-scale. The total number of 4-5 star rated hotels by 2016 is estimated at 337 with about 60,448 rooms (shown in Table 1). With the large number of luxury hotels recently built, Vietnam could meet the demand of high-class customers.

\* Corresponding author. Tel.: 0932.321.612

E-mail address: tranghtt.b@dhtm.edu.vn

**Table 1: The number of 4-5 star rated hotels in Vietnam in the period of 2013 – 2016**

Year	Total		5-star hotel		4-star hotel	
	Number of hotels	Number of rooms	Number of hotels	Number of rooms	Number of hotels	Number of rooms
2013	223	35655	64	15385	159	20270
2014	259	40228	72	17659	187	22569
2015	306	51591	91	24212	215	27379
2016	337	60448	106	30424	231	30024

Source: Tourism Information Center collecting data from Hotel Department (Vietnam National Administration of Tourism) and Departments of Culture, Sports and Tourism

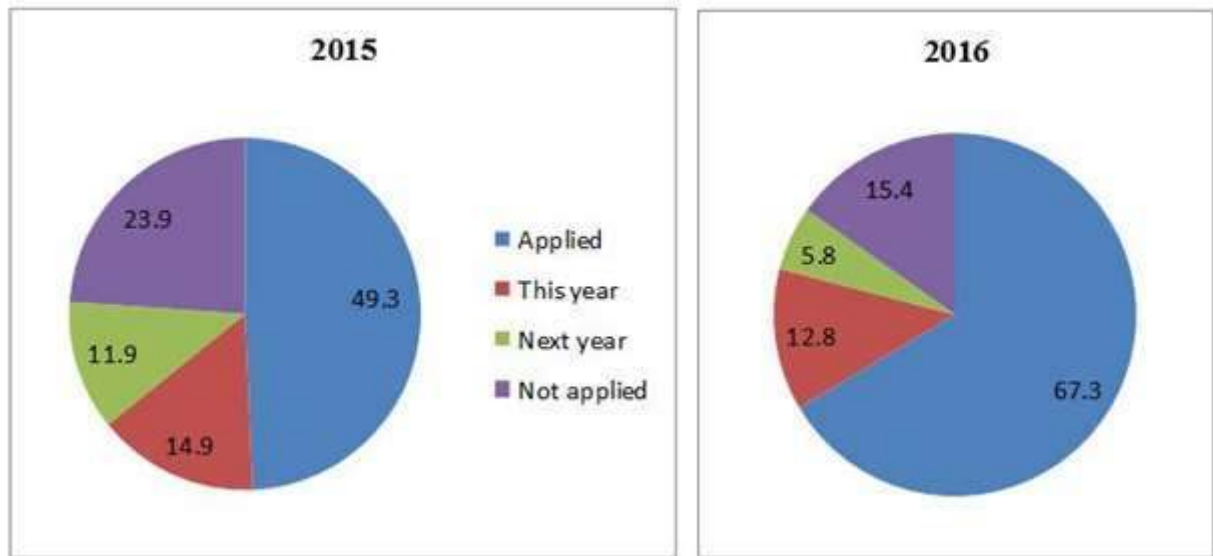

Source: Grant Thornton, 2016&2017

**Fig. 1: Using applications of 4 and 5-star hotels in Vietnam (a) 2015; (b) 2016**

According to a survey by Grant Thornton in 2017, 2016 witnessed the huge increase in the number of luxury hotels using digital technology. These hotels have recognized the importance of adopting digital technology to increase the competitiveness and make the difference in the market. With the impact of Industry 4.0, many luxury hotels in Vietnam have prepared for the upcoming changes. The rate of technology application among hotels has changed significantly, increasing from 49.3% in 2015 to 67.3% in 2016. Furthermore, about 18.6 per cent of hotels will adopt technology in this year and next year. The number of hotels that have decided not to apply technology has fallen from 23.9 per cent to 15.4 per cent, most of which are located in the Central and Southern of Vietnam. Thus, it can be said that 4-5 star rated hotels in Vietnam have seen the changes that could be brought by Industry 4.0 in the coming years (see Fig. 1).

## 2. Basic features of a 4-5 star hotels in Vietnam

4-5 star hotels are a group of hotels heavily influenced by the 4.0 revolution, which is mainly due to the features of the business and human resource of this hotel group. According to the Vietnam National Standard hotel rating (TCVN 4931: 2015), this hotel group has the following features:

Firstly, 4-5 star hotels are the hotels providing highest quality services in the current standard of accommodation in Vietnam. They must have a scale of at least 80 rooms, ensuring the standard of basic services (accommodation, F&B); provide some additional services such as conference, spa, fitness, etc. and standard facilities meeting the demand of luxury serving. With the requirements of equipment and management system, modern science and technology is essential for the hotels. These hotels also take the lead in using new technologies to create unique services.

Secondly, the services of the hotels should follow a high standards of provision, professionalism, and require close coordination among internal units of the hotel. The service procedures comply with VTOS. This standard is appraised, approved and issued by the Vietnam Tourism Certification Board (VTCB) in 2013.

Thirdly, the hotels require a highly qualified staff. 70% of the front-desk personnel should have a vocational

certificate, 30% attending professional training who could use basic IT tools. Leaders of sections should hold a vocational degree in hospitality and have at least two years professional experience. For the manager, they are required to hold a bachelor degree in Tourism and Hospitality and have at least 2-3 years professional experience (TCVN 4931: 2015). On the other hand, the other personnel including human resource, sales and marketing, IT should be able to update the advanced tools to support HR management, service and marketing.

Forthly, the targeted customers are high income customers with high-quality demand. The price of this hotel group is in the highest price categories in providing accommodation services. Along with the high price is the level of service quality. In order to meet the customer satisfaction, the support of technology in management and service delivery is indeed necessary.

Fifthly, other requirements. The 4-5 star hotels need to have a system of environmental sanitation, security and fire safety. Consequently, they must have a garbage disposal system and modern security control equipment.

With the above-mentioned features, 4-5 star hotels in Vietnam should be provided with the basic information about the impact of the 4.0 revolution on their business to create competitive advantages in the near future.

### 3. The impact of Industry 4.0 on the hospitality business in Vietnam

At the World Economic Forum (WEF) on ASEAN in Cambodia in the mid May of 2017, many experts believed that if ASEAN in general and Vietnam in particular do not embrace Industry 4.0, they will become backward in not only the quality but also the volume. This backwardness is led by the fact that all the creations are not in ASEAN. Disruptive technologies like artificial intelligence are transforming global production systems, which poses many new challenges to enterprises generally and services companies particularly. The hotel industry with the using of direct labor could be partially affected. In Vietnam, recently, these affects could be mentioned as follows:

#### 3.1. Opportunities

Embracing Industry 4.0, 4 -5 star rated hotels in Vietnam could unlock the following potentials to develop, such as:

Firstly, Vietnamese government and the industry associations support

The media said that nowhere in ASEAN, Industry 4.0 is discussed as much as in Vietnam. This creates a huge advantage for enterprises and hotels to grasp the positive affects of Industry 4.0. Vietnamese government focus on the development of Information and Communication Technology. Also, they create various measures to facilitate enterprises to take advantage of positive impacts from Industry 4.0 such as: creating an open legal environment, developing the infrastructure, prioritizing to develop the high-tech labor, boostings the communication, etc. On the other hand, many workshops have been organized by industry associations to provide enterprises with more information and knowledge to prepare themselves towards changes led from Industry 4.0. 4-5 star rated hotels are having a great advantage to develop in the coming time.

Secondly, technology helps improve the efficiency of hotel operations management

Applying new technology helps 4-5 star hotels to improve the efficiency of management and business activities significantly. Some applications that are successfully used by the hotels include:

Hotel software management:

Application of modern and advanced hotel management software helps to optimize the using of rooms. It is considered the best way to manage the hotel from check-in, check-out to staff management. Traditionally-managed hotels, especially big hotels often faces the problems of loss of money, slow reports, financial risk, wasting time in management; which could be overcome effectively by using hotel software management. Recently, with the flourish of information technology along with the spread of the Internet, it is a tendency of the hotels to manage their operations through smart mobile devices to create the optimal management. Only with a mobile device such as an iPad, an mobile phone... being intergrated with a hotel software, the entire hotel business will be updated continuously in the most efficient way. Using the software will help to save times and control the situation. As such the hotels could proactively coordinate their business plans. Moreover, regularly and automatically updating reports will help to simplify the tracking of sales of the hotel or its affiliates.

KPIs to measure the performance of the hotel:

Through KPIs, the managers could promptly define the issues and make timely decisions and actions. KPIs measure the performance of individuals, units; control and report the data before implementing the next business plan. KPIs are built on state-of-the-art technology that delivers strong performance and supports multiple users simultaneously.

Thirdly, boosting product promotion and creating a close connection with customers

According to [www.internetlivestats.com](http://www.internetlivestats.com), by early 2016, 40 per cent of the world's population equivalent to 3.4 billion users use the internet, which number keeps rising. In Asia alone, in 2015 internet users accounted for 48.2 per cent of the more than 1.5 billion internet users worldwide. In Vietnam, 44 per cent of the population use the Internet, 65 per cent of which are accessed by smart phones and 75 per cent by laptops (ITDR, 2017). With the increasing number

of users, internet offers a great deal of opportunities for users to exchange and consume hotel products through accessing to up-to-date and public information in the internet. It means that the application and exploitation of technology and Internet is no longer an option but has become an essential requirement in all business activities and promotions of the hotels.

Besides the website, there have other popular and effective e-marketing tools being used such as: Facebook, Youtube, Google, Instagram. Statistics show that Google and Facebook are currently the best two promotion tools, in which Facebook is popular for the ability of reaching targeted consumers accurately and being very friendly in communication. And as the world's largest video channel, Youtube allows users to post free videos, creating excellent conditions for the hotels to express their most exquisite insight about products and services. Videos with the actual footage of hotel services, impressive designs bring a combination of visual and audiovisual elements, which makes it easy for the viewers to visualize the hotels's products or services and also helps the hotels convey their messages to customers in the most effective way. Hotels could save costs remarkably compared to traditional forms of promotion. E-marketing is very popular among high-class hotels regionally and internationally.

In Vietnam, many 4-5 star hotels have raised their business efficiency by e-marketing to expand their booking channels. According to a survey by Grant Thornton, this promotion method has generated about 20 per cent of the bookings of 4-5 star hotels in Vietnam from 2014 up to now; and it will probably increase in the future (Thornton, 2017). On the other hand, according to a survey by Q&Me – a Vietnamese market research firm, 88 per cent of foreign visitors to Vietnam get the information online, 35 per cent of which regularly use the internet to look up tourist information. Google Trends show that the number of the keyword "travel" searching is tripled in the last five years. Local travel information searching often includes destinations, hotels, restaurants, travel experiences, etc. These factors give a favorable condition for travel and high-class hotel business in Vietnam to grow in the context of Industry 4.0.

Forthly, improving services quality and customer satisfaction

Regarding hotel industry, it could be said that Industry 4.0 has tremendous effects in improving services quality and customer satisfaction. Technology enables hotel staff to reduce the time for providing services and facilitate their customers better during their stays. Utilities which have been used by high-class hotels around the world to improve the quality of services include checking-in and -out via Ipad, using RFID key or room lock using mobile phone, smart TV connected to your mobile devices, placing orders online in the restaurant, "hi-tech tour" around the hotel with an Ipad, using e-wallet, etc. Customers will experience unique and advanced services with a shorter waiting time. Especially, for hotel groups, storing customers' information and their hobbies by a management software will promote the efficiency in customer care when they accommodate in their hotels. Smart technology systems will also provide guests with hotel amenities and services, local tourist information, shopping locations during their stay. In addition, technology applications enable the hotels to grasp the complaints of customers quickly through their reviews online. As such, the hotels can quickly adjust their services to give customers a better experience. If the 4-5 star hotels in Vietnam can apply these technologies, they will have the conditions to improve service quality and customer satisfaction in the future.

Fifthly, chances to vary the business cooperation

Online travel agencies and hotels booking websites are born by the development of information technology. This brings the hotels more chances to cooperate than traditional associates. Currently, 4-5 star hotels often shake their hands with 2 types of websites: 1/ websites that provide travel products such as Expedia.com, CTrip.com, Priceline.com, Trippi.com [4]; 2/ websites that facilitate the booking as Booking.com, Hotels.com and Agoda.com (N.K Trinh, 2016). This diversity of links helps the hotel to increase customer accessibility and bookings efficiency. Currently, over 90% of the booking rates of 4-5 star hotels are from the above sites, of which the majority of inbound book through Agoda.com. However, according to the Vietnam E-commerce Association, Online payment of new domestic tourism reached 10%. This share is lower than the Asia Pacific market for online travel products (40%) (ITDR, 2017). In conclusion, hotel industry will definite face many difficulties in applying new technology.

### 3.2. Challenges

Along with the opportunities and advantages brought by Industry 4.0, 4-5 star hotels in Vietnam also face a number of challenges.

Firstly, lack of high-quality labor forces

According to the International Labor Organization (ILO), Vietnamese productivity is lower than that of Singapore (less than 15 times), Thailand or Malaysia (4.5 times lower). Regarding tourism, the statistics of Vietnam National Administration of Tourism (2016) show that only 7.5% of tourism labor are trained at as graduate and postgraduate, about 50% as college and vocational training, the others primary training (D.T.T Hoa, 2017). It is lacking in the senior management of the hotel from supervisor to section leader. Although the labor force has seen an integration in the region, the current average qualification of Vietnamese labor forces is still lower than those of Singapore, Malaysia, Thailand and Indonesia. At the moment, around 80 per cent of 4 – 5 star hotels in Vietnam have to hire foreigners as CEO. All statics show that Vietnam is lacking of high-quality labor, especially labor at managerial level, which makes it difficult to improve the products/services and increase the competitiveness of hotels in the coming years.

Besides, Vietnam is also lacking in the technical labors who are skillful of using technology of Industry 4.0 into

business activities. Almost 4-5 star hotels in Vietnam has applied technology in their marketing. However, undiversified marketing tools and uncreative marketing forms lead to not attracting potential customers such as Thailand, Indonesia or Malaysia. This is partly because we are short of manpower. According to the Ministry of Information and Communications, the quality of our hi-tech manpower is failing to meet the demand. The number of human resources with postgraduate qualifications in the field of science and technology only accounts for about 10 per cent, science labors with researching activities is only about 35 per cent [1]. In general, short of manpower is the whole picture, the hotel industry is no difference, which could not meet the demand for implementing e-marketing activities in the context of Industry 4.0.

Secondly, the challenge of competitiveness

Advantages of improving the quality of products and customer satisfaction of Industry 4.0 also bring the challenge of competitiveness. Industry 4.0 gives a better condition for 4-5 star hotel not only in Vietnam but also in other countries in Asean. Vietnam's hotels are facing the competition in price, quality and uniqueness. In the region, we could see in some markets with developing tourism as Thailand, Malaysia, Indonesia. Hotels in these markets are invested with the quality, modern facilities and exclusive services. They have the advantage of local high-quality labor forces, small proportion of foreign managers. 4-5 star hotels in Vietnam have the investment from foreign investors and hotel groups, which make it feasible to improve facilities and the quality of services inspite of the challenge. However, hiring foreigners at managerial level increases the cost of 4-5 hotels in Vietnam. According to Thorton Vietnam (2016, 2017), in the operation costs of 4-5 hotels in Vietnam, costs for management take more than 23 per cent, only less than the total cost for staff salary (34.8 per cent). It could be said that management cost of hotels in Vietnam is quite higher than of those in the region. This mainly attributes to the average price of 5-star hotels in Vietnam (\$US 111) making it higher than in other countries in the region (Thailand, Indonesia - \$US 100) (only lower than the Philippines nearly \$US 160) (Thorton, 2016). Customers can easily compare hotel prices through websites as trivago, wego etc. It partly reduces the competitiveness of hotels in Vietnam.

Thirdly, challenge from media communication, especially communication through social networks

Today, media is considered the fourth power behind the Legislature - the Executive and the Judiciary. Communication can facilitate businesses to reach customers faster and more efficiently. But the hotels also face a big challenge if not used properly. It expresses through estimating the pros and cons of media providing customers with information of high-quality services, addressing the "over-the-night" business which makes customers not continue their products/services using, even leave bad comments about the products/services in the social networks. The press is the official media under the control of the law but the social network is the personal channel. Hotels can not control the bad feedbacks spreading in social networks, also can not call the help of the authorities. That could cause bad impressions about hotel services in the mind of potential customers. On the other hand, communications help customers compare the quality and price between hotels, between destinations or countries. If hotels in Vietnam do not improve the quality, enhance their attractiveness and build the image in the future, they will not compete in the region.

#### 4. Conclusion

In conclusion, it can be said that the Industry 4.0 will have an increasingly strong impact on every business and in a worldwide scale. Being aware of its impact on the business and having proper strategies/action plans are the first steps to help enterprises in general and hotels in particular succeed in the future. Hotels in Vietnam should take temporary measures such as taking advantage of the government's attention, exploiting social media in promoting and improving the quality of services, making use of the temporary rotation of labor forces within the area or the linkage between business and universities to enable the creation of human resources to meet current and future needs. These feasible suggestions may help the hotel make the most of the opportunities and handle the challenges in the short term. In the long term, enterprises should do more specific researches in order to develop strategies suitable for the current status of their business. Consequently, the hotels as well as the entire hospitality industry could grow and compete with those of other developed countries regionally and internationally.

#### References

- [1] Ministry of Information and Communications (2014). Paper on Information Technology and Communications Vietnam 2014, Information and Communications Publisher.
- [2] Do Thi Thanh Hoa (2017), Barriers to displacement of Vietnamese tourism workers in the implementation of MRA-TP, Vietnam Today, no.7.
- [3] Nguyen Khanh Trinh (2016), Digital Marketing is effective in promoting tourism, Seminar Promote e-marketing application in tourism promotion and e-commerce in tourism business, VITM.
- [4] Tripi.vn (2016), E-commerce in the tourism industry in Vietnam, Seminar Promote e-marketing application in tourism promotion and e-commerce in tourism business, VITM.
- [5] Grant Thorton (2016), Summary Report of the Hospitality Industry Survey 2016, Grantthorton.com.vn
- [6] Grant Thorton (2017), Summary Report of the Hospitality Industry Survey 2017, Grantthorton.com.vn
- [7] ITDR (2017), The tourism industry of Vietnam has captured the fourth industrial revolution,

<http://www.itdr.org.vn/vi/nghiencuu-traodoi/1433-nganh-du-lich-viet-nam-co-lbat-songr-duoc-cuoc-cach-mang-cong-nghiep-lan-thu-4.html>

- [8] ITDR (2017), Labor mobility within the ASEAN economic community, <http://www.itdr.org.vn/vi/nghiencuu-traodoi/1390-dich-chuyen-lao-dong-trong-cong-dong-kinh-te-asean.html>
- [9] ITDR (2016), Collaborative cooperation in tourism human resources training, <http://www.itdr.org.vn/vi/nghiencuu-traodoi/1289-hop-tac-lien-ket-trong-dao-tao-nhan-luc-du-lich.html>
- [10] [www.chinhphu.vn](http://www.chinhphu.vn)
- [11] <http://www.internetlivestats.com/>, tháng 4/2016



# Using Shannon Entropy to Measure The Volatility of Stock Market: An Empirical Study of Asean Countries

Tran Thi Tuan Anh \*

<sup>a</sup>Trường Đại học Kinh tế TP HCM, Việt Nam

## ABSTRACT

The study uses daily stock price data of ASEAN6's stock market indexes, including Indonesia, Malaysia, Philippines, Singapore, Thailand and Vietnam for the period from August 2001 to December 2016 to measure volatility by Shannon entropy. The results show that if Shannon entropy is used to rank the volatility of stock market, Vietnam VNINDEX's returns is the most volatile among six ASEAN stock indices, and followed by Indonesia, Singapore, Malaysia, Thailand and the Philippines, respectively. Given the advantages of using entropy to measure stock volatility, it can be seen that Shannon entropy has yielded different volatility results from traditional measurement by standard deviation. However, entropy is still not used to measure risk in studies in Vietnam. Therefore, the potential research is to understand and promote the application of entropy in finance in Vietnam, especially in investment portfolio and asset pricing.

**Keywords:** Volatility of stock returns, standard deviation, entropy, entropy Shannon, probability density function

## 1. Introduction

The volatility of the stock market is one of the major issues of financial research. Volatility helps to demonstrate the variation of the market due to the fluctuations of the whole market portfolio and of the individual financial assets. The traditional approach to measure market volatility is to use variance or standard deviation of stock returns. However, measuring of volatility by the standard deviation has certain disadvantages. In recent years, one of the new approaches to measure the market volatility is the use of entropy. Entropy is a concept of thermodynamics first introduced by Rudolf Clausius (1870). The concept of entropy is increasingly extended to other fields, including information theory and economic research. With the approach by using entropy to measure stock market volatility, the rest of the paper is organized as follows: Section 2 introduce the overview of entropy and how to use entropy to measure the volatility of the stock market; Section 3 describes the data and research methodology; Section 4 calculate and analyzes the results and Section 5 gives conclusions and some implications from the results of the study.

## 2. Theoretical background and literature review

### 2.1. Measuring the volatility of stock market

Volatility is often closely linked to the concept of risk and uncertainty. Based on the previous studies, market volatility can be divided into two categories: time-invariant and time-variant.

Let denote  $P_t$  the stock price at time  $t$ . The return of stock is given by

$$r_t = \ln \left( \frac{P_t}{P_{t-1}} \right) \quad (1)$$

The time invariant volatility of return  $r_t$  is measured by the variance or standard deviation of  $r_t$  with the following formula:

$$\text{Variance} \quad \hat{\sigma}^2 = \frac{1}{T-1} \sum_{t=1}^T (r_t - \bar{r})^2 \quad (2)$$

$$\text{Standard deviation} \quad \hat{\sigma} = \sqrt{\hat{\sigma}^2} = \sqrt{\frac{1}{T-1} \sum_{t=1}^T (r_t - \bar{r})^2} \quad (3)$$

The advantage of measuring volatility by standard deviation is simple to calculation and easy to interpret. However, this measure also has certain disadvantages. Firstly, variance or standard deviation is easily affected by abnormal observations. In the formula for the variance, the distance from a particular observation to the mean will be squared, so the effect of outliers will be emphasized. Secondly, variance and standard deviation only account for linear relationships and ignores dynamic nonlinear relations that exist in the data. Thirdly, because of the time-invariant nature, variance and standard deviation treat the variation of different periods being equal. In fact, the volatility may be fluctuated over time, such as in crisis period. In order to overcome the drawback of the traditional approach, many researchers propose using the concept of entropy to measure the volatility of the stock market.

## 2.2. What is entropy? How to use entropy to measure the stock market volatility?

Entropy is a concept of thermodynamics, introduced by Rudolf Clausius (1870). Nowadays, the usage entropy is increasingly expanding into many other fields, including information theory and the economic research. In general, the term entropy refers to disorder or uncertainty. In information theory, entropy measures the information of message. The amount of information in the message, called information content, it can be determined by a mathematical quantity. If the message is expected with a certainty of 100%, the message content is zero; that means the uncertainty of the message is zero. As the news of a certain phenomenon increases, it also reduces the unknown or uncertainty of the phenomenon, entropy also reduces.

To link the information content of a message, denoted by  $I$ , with probability, Shannon suggest the following formula:

$$I = \log_2(1/p), \quad (4)$$

where  $p$  is the probability of the result contained in that message. By this formula, information content indicates the number of bits that can be used to represent the message.

The concept of entropy is also extended in probability theory. The entropy is used to measure the uncertainty of a random variable. One of the most popular entropy is Shannon (1948) entropy. Shannon's entropy for a discrete random variable  $X$  is expressed as follow:

$$H(X) = \sum_{x \in \text{range}(X)} p(x) \log_2 \frac{1}{p(x)}, \quad (5)$$

where  $p(x) = \Pr(X = x)$  is the probability that the random variable  $X$  gets value of  $x$ .

If  $X$  is a continuous random variable, the entropy of  $X$  is called differential entropy. Denote  $f(x)$  is the probability density function of  $X$ , the Shannon differential entropy is obtained by

$$H(X) = \int f(x) \ln \left( \frac{1}{f(x)} \right) dx = - \int f(x) \ln(f(x)) dx \quad (6)$$

On the stock market, the stock return can be seen as a continuous random variable. The variation of stock return demonstrates the uncertainty about the profit of investment on stock. Therefore, entropy is well suited to use in measuring the volatility of stock return, as the nature of the entropy is also to express the uncertainty.

## 2.3. Literature review

The application of entropy in finance can be considered as an extension of information entropy and entropy in probability. Normally, variance and standard deviation are the popular measures to reflect the volatility and analyze the uncertainty of financial markets. However, by nature also to measure uncertainty, entropy can be used as alternative way of measuring market volatility. In fact, in recent years, entropy has become an important tool for measuring stock market volatility, especially in portfolio selection and asset pricing.

Bentes et al (2012) introduce the way to Shannon entropy and Tsallis entropy as a new tool for measuring stock market volatility. The authors used data of stock indexes from 7 countries, including CAC 40 (France), MIB 30 (Italy), NIKKEI 225 (Japan), PSI 20 (Portugal) IBEX 35 (Spain), FTSE 100 (UK) and SP 500 (USA) to calculate and compare volatility between 7 stock markets. The results by using entropy are compared to the traditional standard deviation. They suggest that entropy is more appropriate to measure dispersion and volatility in the stock market.

Bose et al. (2012) also proposes a different approach with entropy, named superinformation, to measure variation when stock returns do not follow the normal distribution. Superinformation helps to capture the chaos of these stock returns. The authors apply this for 100 stocks in the list of S&P 500 on US stock market.

Sheraz et al (2015) again confirm that the application of entropy in financial sector as an extension of information entropy and probability entropy. Authors have employed entropy to measure the volatility of the underlying asset markets of financial markets with weekly and monthly stock returns. They also rank the volatility for market based on computed Shannon and Rényi entropy.

Although the use of entropy to measure the volatility of the stock market has been fairly widespread, there is almost no research has ever used entropy to analyze volatility in Vietnam. With the goal of applying entropy to measure the volatility of the Vietnamese stock market, this study uses Shannon entropy formula for measuring Vietnam stock market as wells other countries in ASEAN and compares the results together.

### 3. Data and research methodology

This paper uses daily stock indexes of six ASEAN countries, including Indonesia, Malaysia, Philippines, Singapore, Thailand and Vietnam during the period from August 2001 to December 2016. These indexes are VNINDEX (Vietnam), STI (Singapore), FBMKCI (Malaysia), SET (Thailand), JCI Indonesia) and FTWIPHLL (Philippines). Each country consists of 5916 observations, which is large enough to analyze volatility by entropy. Data is collected from the Datastream source. The calculations are performed with the support of Stata and Matlab software.

With data of six ASEAN's stock markets from Datastream source, this paper examines the stock market volatility of ASEAN6 in both approaches: the traditional one and the entropy one. The entropy of the stock returns is calculated according to equation (7) of the Shannon differential entropy. The probability density function is estimated by using the histogram which is calculated from the sample data of return series. If the sample data of  $X$  includes observations  $x_1, x_2, \dots, x_n$ , the estimated probability density function is

$$f_n(x) = \frac{v_j}{nh}, \quad (8)$$

where:

$n$ : the number of observations

$h$ : the bandwidth of histogram

$v_j$ : observations that belongs to the  $j^{\text{th}}$  intervals of histogram,  $j = 1, 2, \dots, k$

$k$ : the number of intervals to estimate histogram;

The probability density function estimated from (8) is substituted into (7) to compute the continuous Shannon entropy of the stock returns and then to measure and compare the volatility among stock markets

### 4. Results and discussion

The daily rate of return is calculated from the close prices on the stock markets of the six ASEAN countries including Indonesia, Malaysia, Philippines, Singapore, Thailand and Vietnam from 21 August 2011 to 31 December 2016. Table 1 presents the descriptive statistics of returns on these six countries' stock markets. Each country has 5619 observations. While Vietnam and Singapore have lowest daily returns, Indonesia and Philippines are the two countries with the highest average returns.

**Table 1. Descriptive statistics of stock returns in ASEAN6**

Countries	Observations	Mean	Minimum	Maximum
Indonesia	5619	0.044	-10.954	7.623
Malaysia	5619	0.017	-9.979	4.259
Philippines	5619	0.030	-13.276	10.303
Singapore	5619	0.011	-8.696	7.531
Thailand	5619	0.028	-16.063	10.577
Vietnam	5619	0.011	-7.062	6.669

The fluctuations of the daily rates of returns in ASEAN 6 are shown in Figure 1 to Figure 6. It can be seen from these figures that the variation of stock returns changes over time, especially in the period 2008 to 2010 which is corresponding to the period of global crisis.

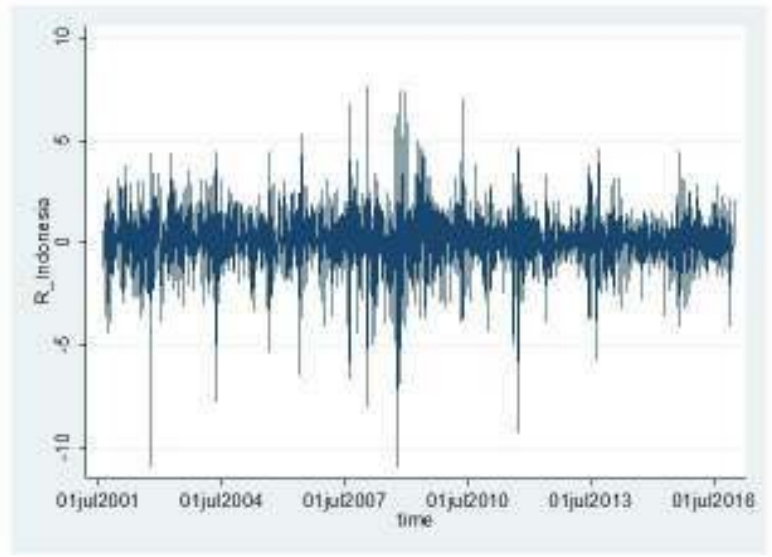

**Fig. 1. Return series of Indonesia stock market**

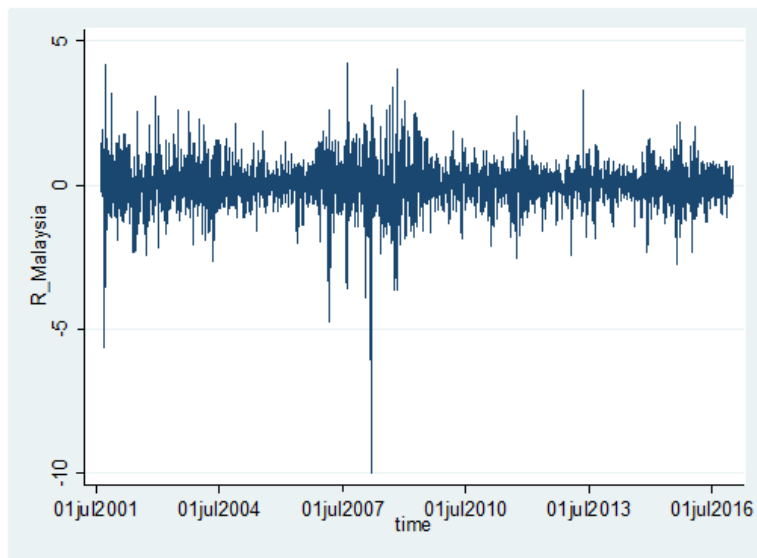

**Fig. 2. Return series of Malaysia stock market**

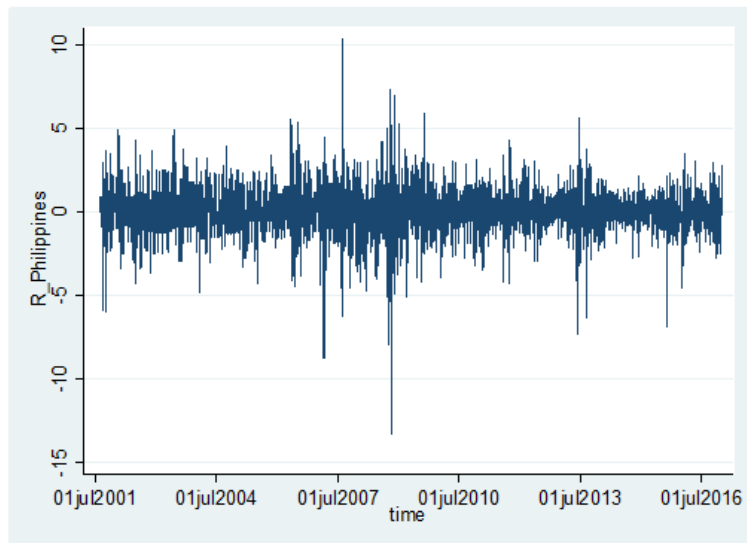

**Fig. 3. Return series of Philippines stock market**

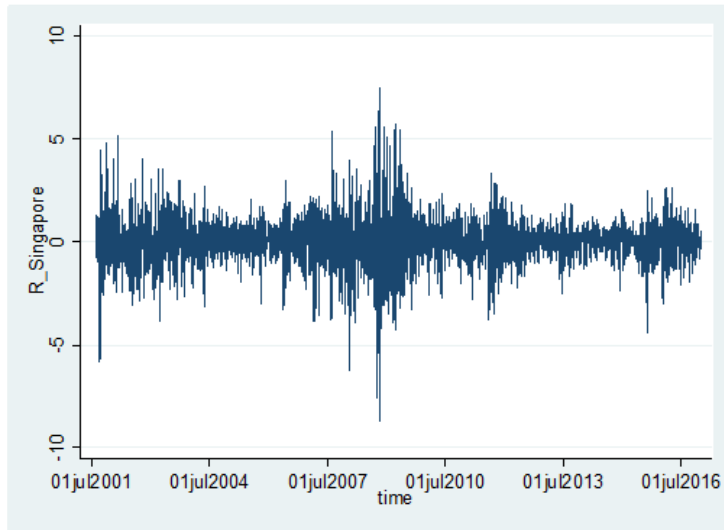

**Fig. 4. Return series of Singapore stock market**

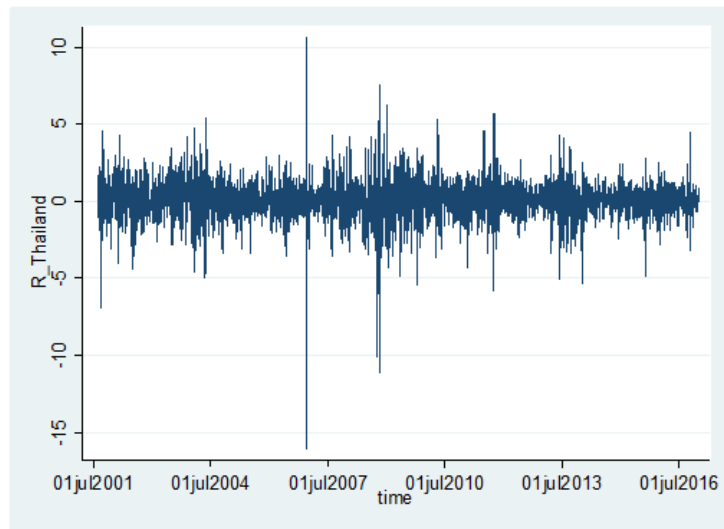

**Fig. 5. Return series of Thailand stock market**

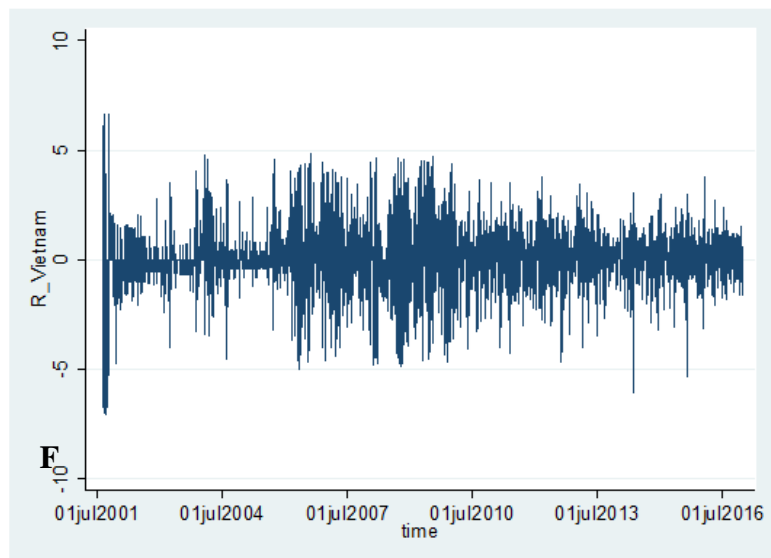

**Fig. 6. Return series of Vietnam stock market**

#### 4.1. Measuring the volatility by standard deviation

Table 2 shows the standard deviations of stock indices in six ASEAN countries. Standard deviation is a traditional tool for measuring the volatility of a stock index. Considering the volatility measured by the standard deviation, the volatility of the markets could be ranked in the following order:

1. Vietnam
2. Philippines
3. Indonesia
4. Thailand
5. Singapore
6. Malaysia

**Table 2. Standard deviations of return series on ASEAN 6's stock market by year**

Year	Indonesia	Malaysia	Philippines	Singapore	Thailand	Vietnam
2001	1.018	1.036	1.315	1.452	1.483	2.395
2002	1.256	0.672	1.171	1.005	1.056	0.720
2003	0.975	0.599	1.124	1.012	1.022	0.766
2004	1.132	0.596	1.000	0.680	1.250	1.093
2005	0.929	0.401	0.978	0.531	0.731	0.647
2006	1.080	0.433	1.159	0.713	1.299	1.681
2007	1.232	0.862	1.564	1.154	1.010	1.413
2008	2.020	1.133	1.843	1.802	1.748	1.928
2009	1.267	0.664	1.260	1.371	1.296	1.796
2010	1.038	0.452	0.957	0.698	0.916	1.104
2011	1.219	0.595	1.020	0.947	1.161	1.111
2012	0.701	0.359	0.787	0.595	0.658	1.042
2013	1.099	0.462	1.257	0.529	1.080	0.899
2014	0.694	0.422	0.635	0.453	0.673	0.922
2015	0.895	0.576	0.761	0.652	0.710	0.866
2016	0.723	0.439	0.960	0.751	0.731	0.731
<b>Entire sample</b>	<b><u>1.128</u></b>	<b><u>0.626</u></b>	<b><u>1.143</u></b>	<b><u>0.947</u></b>	<b><u>1.078</u></b>	<b><u>1.232</u></b>

#### 4.2. Measuring the volatility by Shannon entropy

Table 3 demonstrates the results of Shannon entropy calculation to measure stock market volatility with daily returns. Based on the Shannon's entropy calculations from the sample of 5916 observations, the return of the VNINDEX on the Vietnam stock market has the highest volatility among six countries with Shannon entropy calculated as 1.747. Following was the JCI's returns of the Indonesian stock market with Shannon's entropy calculated as 1.395.

In addition, the FTWIPHLL (Philippines) index has the lowest variation in Shannon entropy, with the value at 1.066. The volatility of Thailand's SET index is also very low with the Shannon entropy at 1.083.

**Table 3. Shannon entropy of ASEAN 6's stock returns by year**

Year	Indonesia	Malaysia	Philippines	Singapore	Thailand	Vietnam
2001	2.146	1.682	2.170	2.170	2.106	2.103
2002	1.610	2.126	2.099	2.121	2.145	2.242
2003	2.092	2.173	2.111	2.296	2.403	1.126
2004	1.759	2.140	2.147	2.115	2.155	1.810
2005	1.795	2.108	2.257	2.006	2.138	1.473
2006	1.642	2.079	1.997	2.032	1.024	2.538
2007	1.825	1.753	1.583	2.173	2.133	2.483
2008	1.866	1.635	1.649	1.961	1.667	2.688

2009	2.260	2.233	2.012	2.253	2.048	2.678
2010	1.773	2.109	2.222	2.321	1.844	2.207
2011	1.621	2.127	2.031	2.266	1.899	2.395
2012	1.892	2.221	2.243	2.298	2.261	2.162
2013	1.954	1.521	1.723	2.146	2.061	2.072
2014	1.899	1.951	2.281	2.114	1.652	1.813
2015	1.952	2.088	1.615	1.813	1.860	1.984
2016	2.035	1.899	2.096	2.208	1.776	2.047
<b>Entire sample</b>	<b>1.395</b>	<b>1.159</b>	<b>1.066</b>	<b>1.202</b>	<b>1.083</b>	<b>1.747</b>

Ranking the volatility of stock indexes by Shannon entropy, the order from the highest to lowest volatility is:

Vietnam  
Indonesia  
Singapore  
Malaysia  
Thailand  
Philippines.

The results of using Shannon's entropy are similar those of standard deviation. That is, Vietnam and Indonesia are still in the top three of the most volatile market. Additionally, Thailand and Malaysia are the countries with the lowest volatility. However, the specific ranking order of volatility is not the same as standard deviation.

The difference between two approaches may be explained by the fact that the use of Shannon entropy to measure volatility accounts for more information than standard deviation does. According to Bentes (2013), volatility by Shannon entropy has many advantages. Firstly, the entropy is more general and relevant to describe market volatility by combining more information about the changes in returns and the probability of these changes, while standard deviation uses only the magnitude of the difference between return and the average. Secondly, entropy does not depend on the distribution of returns. Entropy requires neither normality assumption nor symmetric distribution of return series.

## 5. Conclusion

This paper uses Shannon entropy to measure the stock returns' volatility in six ASEAN stock indices, including the VNINDEX (Vietnam) index, STI index (Singapore), FBMKCI index (Malaysia), only SET (Thailand), N in measuring volatility, entropy is also one of the measures of dispersion as well as risk of investment on stock. The use of entropy to measure risk in portfolio selection or in capital asset pricing models has gradually become popular. However, entropy is still not applied to reflect risk in in finance in Vietnam. Therefore, the potential research in Vietnam is to promote the application of entropy in assess risk on Vietnam stock market.

## References

- [1] Bentes, Sonia, & Menezes, Rui. (2012), Entropy: A new measure of stock market volatility? Journal of Physics: Conference Series 394 (2012) 012033
- [2] Bose, Ranjan. & Hamacher, Kay. (2012). Alternate entropy measure for assessing volatility in financial markets, Physical Reviews E86, 056112 (2012)
- [3] Shannon, C. E. (1948) Bell Systems Tech. **27**, 623 (1948)
- [4] Sheraza, Muhammad, Dedu, Silvia., & Preda, Vasile (2015), Entropy Measures for Assessing Volatile Markets, Procedia Economics and Finance 22 ( 2015 ) 655 – 662

# The Role of Price Consciousness in The Relationship between Prestige Sensitivity and Customer's Price Acceptance in Viet Nam Mobile Phone Market

Nguyen Thi Huyen\*

Faculty of Economics, Pham Van Dong University, Quang Ngai, Viet Nam. PhD candidate of National Economics University, Hanoi, Viet Nam

## ABSTRACT

The purpose of this study is to examine the effect of prestige sensitivity on mobile phone customer's price acceptance in Viet Nam and the mediating role of price consciousness on this relationship. Data was collected via questionnaires with sample of 605 consumers who purchased mobile phone. The collected data was analyzed by applying structural equation modeling method with AMOS 20. The result indicates that prestige sensitivity has both direct and indirect effects on price acceptance via price consciousness. The findings suggested that prestige sensitivity and price consciousness can be used as criterions for effective mobile phone market segmentation and also as a basis for determining the price for each market segment.

**Keywords:** mobile phone, prestige sensitivity, price acceptance, price consciousness, individual differences

## 1. Introduction

Mobile phone market in Viet Nam includes many customers with different characteristics, many segments corresponding to different responses to price. Mobile phones have relatively short product life cycles and the level of competition in the market is quite fierce. This requires policies must be accurate and appropriate.

Price acceptance reflects customers attitude to price, it is a kind of consumer response. From business perspective, price is very important. It directly impacts the revenues, but it is very difficult to estimate [1]. Consumers differ in how much they are willing to pay for a given product. These differences make managers more difficult in pricing. Managers must understand customers attitudes to product prices as much as possible for meeting profitability goals. Therefore, exploring factors affecting price acceptance will provide marketing managers with useful implications for selecting and implementing appropriate strategies to improve pricing practices, especially in Viet Nam mobile phone market.

Previous studies showed that individual differences will affect to price acceptance [2]. In the work of Lichtenstein, Bloch [2], individual differences were represented by product involvement and price consciousness, and these variables account for variation in the encoding of price (representing price-quality inferences) and affect to price acceptance. It is so clear that prestige sensitivity is also a salient constructs representing an individual differences but not included in their model. Prestige sensitivity is related to the benefits and social significance that customers are expected to get from buying and using the product. Prestige-sensitive customers believe price is an indicator of prestige [3]. Therefore, prestige sensitivity may affect price acceptance. But only Goldsmith, Flynn [4] suggested that status motivates customers to pay more by examining the effect of status consumption on price sensitivity. Up to now, the impact of prestige sensitivity on price acceptance has not examined.

Beside, prestige sensitivity presents the internal consumer motivation or the needs of products. It promotes activities to satisfy their needs and required some criterions based for appropriate evaluating and selecting. Price consciousness refers to the degree to which the consumer focuses exclusively on paying low prices [3]. It can be seen as a criterion formed in customer mind and used for making pricing decision, thus, according to the framework of buying process [5], it is affected by prestige sensitivity. Nonetheless, prior researches viewed price consciousness as a

\* Nguyen Thi Huyen. Tel: +084.984444424.  
E-mail: [huyenpdu@gmail.com](mailto:huyenpdu@gmail.com)



individual differences, no one estimates the impact of prestige sensitivity on price consciousness. Furthermore, price consciousness is also affirmed as a factor that has a strong influence on price acceptance [2], on the willing to pay [6]. Therefore, it may have a given role in the relationship between prestige sensitivity and price acceptance but has not been explored.

For above reasons, this study was implemented to fulfill these gaps. By clarifying the effect of prestige sensitivity on price acceptance and exploring the role of price consciousness in this relation, the study was expected to contribute to explaining the customers' attitude to price. This study focuses on answering two research questions: (1) is there a direct linkage between prestige sensitivity and price acceptance for mobile phone? (2) What is the role of price consciousness in this relationship?

## **2. Theoretical background**

### **2.1. Price acceptance**

Price acceptance is one of cognitive aspects [7]. The fair price theory proposed the existence of standard price or fair price in consumer's memory. Any price which is higher than the standard price is considered unreasonable and not acceptable by consumers and vice versa [7]. However, this definition is not fully capturing the price acceptance construct because the needs are not mentioned [6]; so it doesn't make sense if consumers don't need any aspect of the product.

For these reasons, Lichtenstein, Bloch [2] redefined price acceptance "a judgment of price based on a comparison of price cue to a range of acceptable prices stored in memory" [2]. Price acceptance has two dimensions: price acceptability level and latitude of acceptable prices. However, in measurement model, Lichtenstein, Bloch [2] only measured acceptance price level by comparing the amount typically paid and the average price paid; therefore, this measurement model may not fully refer to the level of price acceptability. Consequently, although this view is very valuable, it is not suitable for some products.

Therefore, this study applied the definition proposed by Monroe (1990) redefining price acceptance as the maximum price which a buyer is prepared to pay for the product, reflects how consumers feel about paying for the product. Price acceptance was viewed as consumer's appreciation, reaction or interest in the price for a offering. When sellers offer a price or change the price of a product, customers are willing to pay, they are considered to be a high price acceptance consumer and vice versa.

Based on the above analysis, this current study adopts the approach introduced by Monroe [8]. We also consider price acceptance as a kind of consumer response.

### **2.2. Prestige sensitivity**

Many consumers have prestige sensitivity to products. Prestige sensitivity is related to favorable perceptions of the price cue based on feelings of prominence and status that higher prices signal to others [3]. In other words, prestige sensitivity buyers focus on purchasing product that signifies prominence and status. They believe price is an indicator of prestige; the higher price means the higher perceived status. A customer was willing to pay higher price for a mobile phone not because of its quality, but because his/her perception that other people will make a socially positive judgment about him/her by high-price mobile phone he/she bought.

In literature, prestige-seeking consumer relatively equated with status-consumed consumer that was recently expanded beyond the idea of conspicuous consumption. Status consumption was defined as "the motivational process by which individuals strive to improve their social standing through the conspicuous consumption of consumer products that confer and symbolize status both for the individual and surrounding significant others" [9, p.42]. Status relates to consumers being motivated for internal reasons (i.e. self-esteem) and/or external reasons (i.e. others' approval and envy), while conspicuousness relates to purely external reasons [10, 11]. All of them also represent for individual difference variables and was much studied to partly explain the consumers' decision making process.

### **2.3. Price Consciousness**

Monroe and Petroschius [12] viewed price consciousness as the degree a customer is unwilling to pay a higher price for a product, and if the price is greater than what is acceptable to pay, the buyer may cancel the transaction. Moreover, the price conscious customer will not be willing to pay for distinguishing features of a product if the price difference for these features is too large.

In simpler terms, price conscious customers strive to pay low price, they want to lowest prices [13]. Particularly, Lichtenstein, Ridgway [3] used price consciousness to refer to the degree to which the consumer focuses exclusively on paying low prices. They argued price consciousness as a signal of economic sacrifice, as money that must be given up to engage in a given purchase transaction. Price conscious customers try their best for the lowest prices.

This current study follows this approach, specifically, price consciousness refers to striving to pay low price for a given product. It is like a guiding rule in customers' psychology when making a purchase.

### 3. Hypotheses

#### 3.1. Conceptual framework

According to behavioral decision theorists, customer reactions is not always based on their information acquired, but in many cases, it is based on their “mental shortcuts”, bases their prediction on the quickness and easy with outcomes come to mind [5]. They identified in many situation in which customers make seemingly irrational decision. In such cases, their feelings/expectances play a vital role in their responses. This study tried to examine customer reactions to price that is the result of their feelings/expectances relating to products.

As discussed in previous section, prestige sensitivity presents the internal consumer motivation or the needs of products or more some characteristics of products. Price consciousness presents a rule that forming in the customers psychology for guiding the price decision. Price acceptance is considered as customers response/decisions. So, according to the framework of buying process by Kotler and Keller [5] and as stated above, i argue that prestige sensitivity affects to price consciousness. Beside, within the conceptual schema for discussing customer reaction to price by Jacoby and Olson [14], price consciousness have a direct impact on price acceptance. In the next section, I will specify this conceptual framework into research hypotheses and synthesize these hypotheses into the research model.

#### 3.2. Prestige Sensitivity and Price acceptance

As mentioned, prestige sensitivity represents as a positive perception of price cue is based on perception of what it signals to others in social appearance [3]. In simpler terms, prestige-conscious consumers believe that high price operates as a surrogate indicator of prestige. In line with this view, such consumers would prefer high-priced products to low-priced ones. Prestige-seeking people tend to purchase expensive brand which may be displayed their wealth and power and lead to higher prestigious perceive [15, 16]. Furthermore, Lambert [17] suggested that if a consumer believes that his product choice affects how others view him, he prefer to purchase a high-priced items to maintain and enhance his social image. This is in line with reality. It is obvious that prestige-sensitive customers are willing to pay more for the prestige product to impress others.

Accordingly, in case of mobile phone, prestige sensitivity is also expected to be having positive effects on price acceptance. When being higher on prestige sensitivity, consumers associate more with prominence and status, they use price as a signal to their prestige, and then, they are willing to pay higher price for a mobile phone because their perception that other people will make a socially positive view him via the price paid for mobile phone. Therefore, I argue:

H1: Prestige sensitivity has positive on price acceptance of mobile phone consumers.

#### 3.3. Prestige sensitivity and Price consciousness

According to the framework of buying process by Kotler and Keller [5], prestige sensitivity will generates motives to satisfy their needs or desire for their prestige. In the decision-making process, customers generally based on knowledge and information obtained for evaluation process, but in certain cases, their evaluation is purely subjective, based more on their feeling with products, based on their expectance the future outcomes from buying and using products. They also established a set of criteria that was used to make the best decision for their prestige, including price decision. And price consciousness is one of them, because it is naturally a psychological rule that is formed in customer’s mind in the buying process. Hence, it shows that prestige sensitivity affects to price consciousness.

Prestige-sensitive customers views price as a signal to prestige, so when they buy product, especially prestige product, they don’t try to pay lowest prices for product. As a consequence, I argue:

H2: Prestige sensitivity has negative on price consciousness of mobile phone consumers.

#### 3.4. Price consciousness and Price acceptance

In the conceptual schema for discussing customer reaction to price by Jacoby and Olson [14], price consciousness affect to customer’s attitude to price (representing price acceptance).

Customers with negative perceptions view product price as money that must be given up to engage in a given purchase transaction, they try for the lowest prices. With it in mind, they are unwilling pay higher price for the product, as a result, their level of price acceptance will be low. Lichtenstein, Bloch [2] provided an empirical evidence for the negative impact of price consciousness on price acceptance. Beside, Campbell, DiPietro [6] indicated that price consciousness has a negative effect on the willing to pay for product. Therefore, I hypothesize:

H3: Price consciousness has negative on price acceptance of mobile phone consumers.

These above hypotheses are summarized in the following research model:.

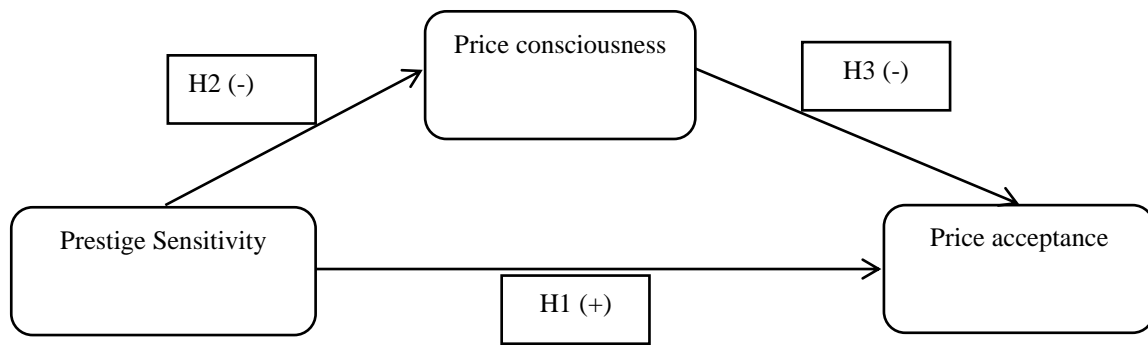

Figure 1: The research model

## 4. Methodology

### 4.1. Measurement of variables

There are 3 variables in this study. All the variables were measured through five-point likert scale ranging from “strongly disagree” to “strongly agree”. For Prestige sensitivity, I adopted a 9-items scale from Lichtenstein, Ridgway [3]. For Price consciousness, I used a 4-items scale also adopted from Lichtenstein, Ridgway [3]. Finally, to measure price acceptance, I used a scale of 4 items adopted from David Martín-Consuegra, Arturo Molina [18]. All scales were translated to Vietnamese and back-translated into English to ensure linguistic and conceptual equivalence between the Vietnamese and English versions.

### 4.2. Stages of research

In order to test the proposed model, quantitative method was used. Because of the new research context, we conducted a quantitative pilot study to preliminary assess of all scales before carrying out the quantitative main study [19].

#### 4.2.1. The pilot study

In quantitative pilot study, we collected 150 questionnaires. Most respondents came from Quang Ngai province and have different works and age range from 24 years old to 38 years old.

Measurement scales used in this current study were empirically validated in previous studies. In this stage, we performed an exploratory factor analysis (EFA) for each scale, and then, its results were used in Cronbach Alpha for each scale to filter and remove garbage items. The result showed scales of price acceptance and prestige sensitivity were as expected (loaded on only one factor). With price consciousness scale, DHGC2 loaded on more one factors, their cross-loadings were above 0.3 and only DHGC2 formed a new factor. Considering its content validity, I removed it from the scale [19]. All items were ready for the quantitative main study.

#### 4.2.2. The main study

##### Data collection and sample characteristics

The data comes from the survey of consumers who purchased mobile phone, above 18 years old, representatives for the regions of Vietnam. In our survey, 1000 questionnaires were sent out by using convenience sampling, and 823 questionnaires were received, resulting in a response rate of 82,3%. After dropping uncompleted responses and outliers from the data set, leaving only a usable completed sample of 605 respondents, resulting in a usable rate of 73.51%.

In our sample, the age mean of respondents was 27, most ranges from 18 years old to 38 years old. They come from different regions of the country, including northern, central and southern Viet Nam with many different occupations. Respondents’ monthly income ranges from less than VND 3 million to more than VND 15 million, the income mean of respondents was VND 4.2 millions/per month. In terms of gender, women account for 66.1% and men account for 33.9%. Most of respondents had bachelor’s degree (74%), 26% had some college or lower education. The major brands of mobile phones they owned are Samsung (24.1%), Apple (23,5%), Nokia (14.5%), Lumia (13.6%), Oppo (11.1%) and other brands. Most their their mobile phone are priced at less than 6 million (71.24%). About 78.7% of the respondents owned a smartphone.

##### Data analysis

All 17 items remaining after the quantitative pilot study were continued used in exploratory factor analysis (EFA) for all items to facilitate for confirmatory factor analysis (CFA) in next step. Finally, the validated measurement model tested by CFA was used to test the causal relationship by applying structural equation modeling (SEM).

**5. Results**

**5.1. Exploratory factor analysis (EFA)**

The results of EFA showing that two of the three scales were as expected (highly loaded on the respective factor), including price consciousness and price acceptance. However, unlike the results of the quantitative pilot study, EFA show that 9 items from prestige sensitivity scale split into 2 factors. While this scale was modeled as a unidirectional scale [3]. That may be due to the research context, because a scale is unidirectional in this research context but can be multidimensional in other research context [19]. Vietnamese consumers may be rather sensitive with the statements in this scale than others. Consequently, the first 4 items of this scale concerned more with their self-perceived feelings when she/he buys a product (i.e. “feel good”, “feel classy”, “enjoy the prestige”) was formed a factor, while others concerned more with the feelings the consumer think others make judgment about her/him when she/he buys a product (i.e. “your friend will think you are cheap”, “other people would notice”, “others make judgment about me”) was formed an another factor.

This result is consistent with the theory of Fenigstein, Scheier [20]. Fenigstein, Scheier [20] recognized two types of self-conscious people: publicly self-conscious persons are particularly concerned about how they appear to others and privately self-conscious persons are more focused on their inner thoughts and feelings. According to this, the first factor is representative for private prestige and another is representative for public prestige.

**5.2. Confirmatory factor analysis (CFA)**

The full measurement model composed of the remained items after EFA was test by CFA. In this step, we continued to remove item DHGC1 from price consciousness scale because its SRCs (Standardized Residual Covariance) was exceeding 0.4 [21]. According to Byrne [22], the final measurement model was statically well fitted:  $X^2(99)=332.195$ ,  $p=0.000$ ,  $X^2/df=3.356<5$ ,  $GFI= 0.935$ ,  $TLI =0.942$ ,  $CFI =0.952$ ,  $RMSEA = 0.062<0.08$ . All detailed results of CFA for all constructs were presented in the table 1.

As seen in table 1, standardized loading estimates ranged from 0.595 to 0.886, that all were greater than 0.5. All composite reliability (CR) were above 0.7 and Average Variance Extracted (AVE) of all constructs were higher than the cut-off value of 0.5. These results showed that convergent validity is ensured [21]. Discriminant validity was assessed by comparing the square roof of AVE with the inter-construct correlations\_[23]. Table 2 demonstrated all AVE were higher than the inter-construct correlations, discriminant validity is established.

**Table 1: CFA and scale reliability**

Construct	Name	Item description	Standardized estimate
Prestige sensitivity (PS)  CR=0.864 AVE=0.765	<b>Private Dimension</b>		<b>0.737</b>
	NCVT1	People notice when you buy the most expensive brand of mobile phone.	0.773
	NCVT2	Buying a high priced mobile phone brand makes me feel good about myself.	0.843
	NCVT3	Buying the most expensive brand of mobile phone makes me feel classy.	0.907
	NCVT4	I enjoy the prestige of buying a high priced mobile phone brand.	0.886
	<b>Public Dimension</b>		<b>0.993</b>
	NCVT5	It says something to people when you buy the high priced version of mobile phone.	0.708
	NCVT6	Your friends will think you are cheap if you consistently buy the lowest priced version of mobile phone.	0.745
	NCVT7	I have purchased the most expensive brand of mobile phone just because I knew other people would notice.	0.853
	NCVT8	I think others make judgments about me by the kinds of mobile phone categories and brands I buy.	0.853
NCVT9	Even for a relatively inexpensive mobile phone, I think that buying a costly brand is impressive.	0.781	
Price consciousness (PC)  CR=0.759 AVE=0.515	DHGC3*	The money saved by finding low prices is usually not worth the time and effort.*	0.608
	DHGC4*	I would never shop at more than one store to find low prices.*	0.801
	DHGC5*	The time it takes to find low prices is usually not worth the effort.*	0.604
Price acceptance (PA)	CNG1	Sometimes, I am willing to pay more for mobile phone	0.595
	CNG2	I know the reference price level of mobile phone	0.723

CR=0.802	CNG3	I usually accept changes in price of mobile phone	0.785
AVE=0.505	CNG4	I have a good knowledge of price distribution in the mobile phone	0.727

CR: Composite Reliability , AVE: Average Variance Extracted, \*reverse scored

**Table 2: Correlation matrix and AVE statistic**

	CR	AVE	MSV	ASV	PS	PA	PC
<b>PS</b>	0.864	0.765	0.226	0.175	<b>0.874</b>		
<b>PA</b>	0.802	0.505	0.226	0.175	0.475	<b>0.711</b>	
<b>PC</b>	0.759	0.515	0.125	0.124	-0.353	-0.352	<b>0.718</b>

**Note:** Bolded value in diagonal represent square roof of AVE, all correlation coefficients are below this for each construct.

**5.3. Hypotheses testing**

As mentioned, we used a structural equation modeling (SEM) to simultaneously test the proposed hypotheses. The results of SEM indicated that the model achieved a good fit:  $X^2(99)=332.195$ ,  $p=0.000$ ,  $X^2/df=3.356 < 5$ ,  $GFI= 0.935$ ,  $TLI =0.942$ ,  $CFI =0.952$ ,  $RMSEA= 0.062 < 0.08$  [21]. Results of hypotheses testing in table 3 show all hypothesized paths were statistically significant and supported. As expected, prestige sensitivity had a significant positive effect on price acceptance ( $\gamma=0.285$  at  $p=0.000$ ), H1 was supported. The results also support H2, prestige sensitivity was found to have a negative effects on price consciousness ( $\gamma=-0.437$  at  $p=0.000$ ). The results also support H3, price consciousness was found to have a negative effects on price acceptance ( $\gamma=-0.121$ , at  $p=0.000$ ). Beside, if the model had no price consciousness variable, the unstandardized estimate of the relation between prestige sensitivity and price acceptance is 0.353 ( $>0.285$ ). These results indicated the mediating role of price consciousness in the relationship between prestige sensitivity and price acceptance [19].

**Table 3: Results of hypotheses testing**

Hypothesis	Causal Path	Estimate	S.E.	C.R.	P	Hypothesis supported
H1	PA <--- PS	0.285	0.046	6.237	***	Yes
H2	PC <--- PS	-0.437	0.07	-6.236	***	Yes
H3	PA <--- PC	-0.121	0.031	-3.928	***	Yes

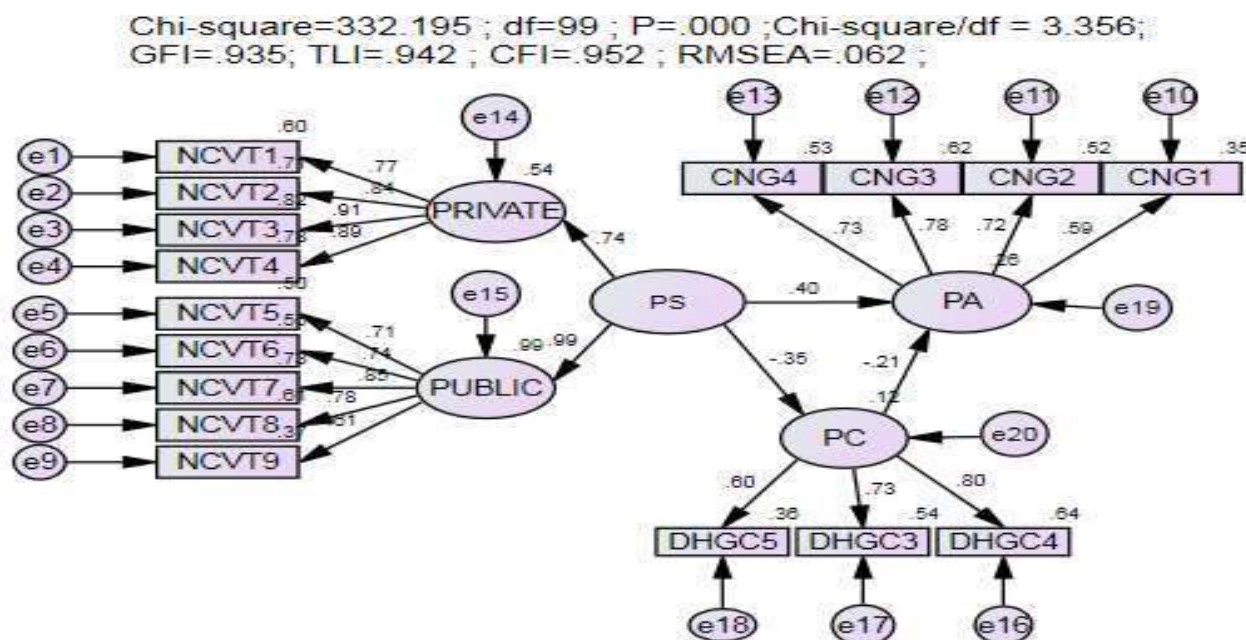

**Figure 2: Results with SEM (standardized estimates)**

The Bootstrap test was also performed with a resampling of 500 indicated that CR is less than 1.96 (see table 4) => the deviation from 0 was not statistically significant at 95% confidence intervals. Thus, it can be concluded that the estimates in the model as Table 3 are reliable. The model explained 26.4% of the variance of price acceptance.

**Table 4: Results of bootstrapping**

Parameter	SE	SE-SE	Mean	Bias	SE-Bias	CR
PC <--- PS	0.057	0.002	-0.349	0.004	0.003	1.333
PA <--- PS	0.057	0.002	0.397	-0.003	0.003	-1.000
PA <--- PC	0.057	0.002	-0.215	-0.004	0.003	-1.333

These findings are discussed in more detail in the next section.

## 6. Discussion and Conclusions

This study focuses on investigating the effects of prestige sensitivity on price acceptance in the context of mobile phone market in Viet Nam. In addition, the mediating role of price consciousness in this relation was proposed and examined.

### 6.1. Theoretical implications

The results of this study contribute to the explanation on the mechanism of customer’s responses to price (price acceptance) in some points.

First, this is the first empirical research explored prestige sensitivity as a significant antecedent of price acceptance. Although prior researchers implied that social significance can affect to customers response to price, but no one examining the effect of prestige sensitivity on price acceptance. This empirical research demonstrated that prestige sensitivity impacts on price acceptance in both directly and indirectly ways. In short, the finding provided empirical evidence that the social significance of customers with a given product has a great influence to their attitude to price. It is expected to create a useful new explanation of price acceptance.

Second, prestige sensitivity has a negative effect on price consciousness. This result indicated that price consciousness is not only an absolute individual difference variable, but it can also be relevant to the level of customer’s prestige sensitivity with a certain product. This finding contributes to account for the level of price consciousness across customers and products. When buying a given product, customers with higher prestige sensitivity becomes to be lower with price consciousness and vice versa.

Third, this study also presented that price consciousness has a negative effect to price acceptance. The result is consistent with the research hypothesis and in line with many prior researches, such as Lichtenstein, Bloch [2], Campbell, DiPietro [6]. This finding proved that this relation is quite stable across research contexts.

Beside, this is also the first study pointing out the mediating role of price consciousness in the effect of prestige sensitivity on price acceptance. This study clarified the role of the psychological price in accounting for price acceptance.

Finally, relating to prestige sensitivity scale, this study presented this scale may be a multidimensional scale. I found two dimensions of prestige sensitivity: private and public dimensions that are in line with the theory of [Fenigstein, Scheier [20]].

### 6.2. Managerial implications

The study showed the vital role of consumer differences toward the change of price acceptance level for the product. The research findings from this study provide a better understanding of the relationship between prestige sensitivity and price acceptance for products, so provide managers with new knowledge on the mechanism through which prestige sensitivity affects customer’s responses to price. This result suggests that managers should focus their efforts on analyzing the consumer-product relationship. It must be the first stage to start a pricing strategic. Its outcome is to determine exactly customer’s level of prestige sensitivity to estimate of how responds the target market to price. This information is one of the key issues to set up a good pricing strategic.

To be more precise, marketers should classify target customers into different groups according to their degree of prestige sensitivity and set up the corresponding price policies. Beside, attracting and keeping more prestige-sensitive customers is also a vital issue because it relates to maximize revenue and profit. Therefore, marketers should understand their customers that are helpful in pricing and customer relationship management.

### 6.3. Limitations and future research directions

This study has achieved a certain success in examining the important relationship between prestige sensitivity and price acceptance in a relatively new research context of mobile phones market in Viet Nam. However, the study has also existed several limitations and these limitations also open some directions for the future researchers. First, relating to sample, although we also tried to assure the representation of the sample by large-scale surveys and respondents come from many regions throughout the country, convenience sampling method is also a limitation of this study. In

addition, the sample can not get a close-to-actual ratio between male and female (33.9%-66.1%), among respondent's age groups. Besides, a comparison of the results among different consumers group across demographic variables was not performed. It would be meaningful for future studies to make it. Moreover, this study considered only a mediating variable in the relation was price consciousness. Other mediating and moderating variables could be added in future studies. Finally, the results achieved may be only valid to the product analyzed. The future researches could study on other products and making a comparison of the results across them.

## References

- [1] Dominique-Ferreira, S., et al., Determinants of customer price sensitivity: an empirical analysis. *Journal of Services Marketing*, 2016. 30(3).
- [2] Lichtenstein, D.R., P.H. Bloch, and W.C. Black, Correlates of price acceptability. *Journal of consumer research*, 1988: p. 243-252.
- [3] Lichtenstein, D.R., N.M. Ridgway, and R.G. Netemeyer, Price perceptions and consumer shopping behavior: a field study. *Journal of Marketing research*, 1993: p. 234-245.
- [4] Goldsmith, R.E., L.R. Flynn, and D. Kim, Status consumption and price sensitivity *Journal of Marketing Theory and Practice*, 2010. 18(4): p. 323-338.
- [5] Kotler, P. and K.L. Keller, *A framework for marketing management*. 6 ed. 2016, USA: Pearson. 344.
- [6] Campbell, J., R.B. DiPietro, and D. Remar, Local foods in a university setting: Price consciousness, product involvement, price/quality inference and consumer's willingness-to-pay. *International Journal of Hospitality Management*, 2014. 42: p. 39-49.
- [7] Berkowitz, E.N. and J.R. Walton, Contextual influences on consumer price responses: An experimental analysis. *JMR, Journal of Marketing Research (pre-1986)*, 1980. 17(000003): p. 349.
- [8] Monroe, K.B., *Pricing: Making profitable Decisions*. 1990, New York: McGraw-Hill.
- [9] Eastman, J.K., R.E. Goldsmith, and L.R. Flynn, Status consumption in consumer behavior: Scale development and validation. *Journal of Marketing Theory and Practice*, 1999. 7(3): p. 41-52.
- [10] Truong, Y., et al., Status and conspicuousness—are they related? Strategic marketing implications for luxury brands. *Journal of Strategic Marketing*, 2008. 16(3): p. 189-203.
- [11] Eastman, J.K. and K.L. Eastman, Perceptions Of Status Consumption And The Economy. *Journal of Business & Economics Research*, 2011. 9(7): p. 9-19.
- [12] Monroe, K.B. and S.M. Petroshtus, Buyers' perceptions of price: An update of the evidence. *Perspectives in consumer behavior*, 1981. 3(23): p. 42.
- [13] Pride, W.M. and O.C. Ferrell, *Marketing*. 2016: Nelson Education.
- [14] Jacoby, J. and J.C. Olson, Consumer response to price: an attitudinal, information processing perspective. *Moving ahead with attitude research*, 1977. 39(1): p. 73-97.
- [15] Byun, S.-E. and B. Sternquist, Reconceptualization of price mavenism: do Chinese consumers get a glow when they know? *Asia Pacific Journal of Marketing and Logistics*, 2010. 22(3): p. 279-293.
- [16] Vigneron, F. and L.W. Johnson, A review and a conceptual framework of prestige-seeking consumer behavior. *Academy of Marketing Science Review*, 1999. 1999: p. 1.
- [17] Lambert, Z.V., Price and choice behavior. *Journal of Marketing Research*, 1972: p. 35-40.
- [18] David Martín-Consuegra, Arturo Molina, and Á. Esteban, An integrated model of price, satisfaction and loyalty: an empirical analysis in the service sector. *Journal of Product & Brand Management*, 2007. 16(7): p. 459-468.
- [19] Nguyễn\_Đình\_Thọ, *Phương pháp nghiên cứu khoa học trong kinh doanh*. 2011, Hà Nội: NXB Lao động- Xã hội.
- [20] Fenigstein, A., M.F. Scheier, and A.H. Buss, Public and private self-consciousness: Assessment and theory. *Journal of consulting and clinical psychology*, 1975. 43(4): p. 522.
- [21] Hair, J.F., et al., *Multivariate data analysis: A global perspective*. Vol. 7. 2010: Pearson Upper Saddle River, NJ.
- [22] Byrne, B.M., *Structural equation modeling with AMOS: Basic concepts, applications, and programming*. 2016: Routledge.
- [23] Fornell, C. and D.F. Larcker, Evaluating structural equation models with unobservable variables and measurement error. *JMR, Journal of Marketing Research (pre-1986)*, 1981. 18(000001): p. 39.

# Foreign Direct Investment in Vietnam: Optimistic or Overrated?

Phung Thanh Quang\*

School of Banking and Finance, National economics University, 207 Giai Phong, Hanoi, Vietnam

## ABSTRACT

Foreign direct investment is the key driver for Vietnam's economic development in recent years, especially after Vietnam joined the WTO in early 2007. By the end of 2016, FDI sector in Vietnam comprised for 25% total investment, 14.8% of state budget revenue, with total FDI accumulated of more than 293 billion USD. This paper analyses some main features of FDI in Vietnam during the ten years period 2007-2016, after Vietnam's accession to the WTO. The author found that FDI in Vietnam has played an increasingly important role for the economic growth, especially on trade performance. However, FDI has been much focused on labour-intensive manufacturing and the linkages of FDI firms with domestic ones remain relatively weak. Most of FDI projects have registered in the form of 100% FDI firms, and around 60% is vertical FDI, with low level of technology and knowledge transfer. Furthermore, the gap between committed FDI and implemented FDI has raised the question about overrated FDI in Vietnam. Based on this, the author suggests some policy implications for attracting green FDI in the context of the fourth industrial revolution.

**Keywords:** Green FDI, Vietnam, Overrated, tax havens.

## 1. Introduction

In the context of integration, foreign direct investment has played an important role for economic development, especially for emerging or transitional economies. Regarding to global investment trends, in 2015, global FDI flows jumped by 38% to 1.76 trillion USD, the highest level since the global economic and financial crisis of 2008-2009. Inward FDI flows to developed economies almost doubled to 962 billion USD, with a strong growth in Europe. Developing economies saw their FDI inflows reach a new high of 765 billion USD, 9% higher than in 2014. Developing Asia, with FDI inflows increasing by 16% to 541 billion USD, remained the largest FDI recipient in the world. The significant growth was driven by the strong performance of East and South Asian economies (UNCTAD, 2016). In this context, Vietnam has become one of the most favorable destinations for FDI attraction worldwide. In 2016, Vietnam ranked 6<sup>th</sup> in Asia and ranked 26<sup>th</sup> worldwide in terms of FDI inflows (UNCTAD, 2016). However, FDI in Vietnam experienced a high fluctuation in the last ten years. This paper finds out some main characteristics of FDI in Vietnam in the light of the fourth industrial revolution and gives some policy implications.

## 2. FDI in Vietnam in the period 2007-2016

With the low labor costs, strong openness to trade and an advantageous geographical location, Vietnam has been one of the most favorable destinations of FDI, especially after Vietnam's accession to the World Trade Organization in 2007. After one year joining the WTO, committed FDI reached a record high of 71.7 billion USD, 3.4 times higher than FDI commitments in 2007 (table 1). The main reasons for this surge were the wider investment opportunities, predictability and high responsibility for policy reforms in Vietnam after WTO accession. In the period 2009-2011, FDI registered declined dramatically, standing at 15.59 billion USD in 2011, which was the lowest level since 2007. It was caused mainly by the global financial crisis and some domestic factors such as the macroeconomic instabilities, power shortage and lack of skilled workforce. In a positive sign, despite the significant decline in FDI commitments, FDI implement saw a slight increase in the period 2009-2011, stood at 11 billion USD in 2011. Notably, foreign investors gradually shifted away from speculative real estate sector to manufacturing, resulted in an increase in employment and

\* Corresponding author. Tel.: +84. 904657189  
E-mail address: pt\_quang@neu.edu.vn



output (World Bank, 2016). In the period 2012-2016, committed FDI recovered significantly, from 16.3 billion USD in 2012 to 24.37 billion USD in 2016. FDI implements also experienced an upward trend, with an annual growth of 9.7% in this period. Up to the end of 2016, Vietnam attracted investments from 116 countries and territories, with total accumulated FDI commitments of 293.25 billion USD (equal to more than 150% of GDP). Only in 2016, there were 2556 new registered projects, with 24.37 billion USD of committed capital. Notably, there were 1020 new projects in processing and manufacturing industry with total committed capital of 15.53 billion USD, accounting for 64% total investment capital, followed by electronic, fuel manufacturing and real estate, which comprised 11.6% and 7% of total FDI committed respectively.

**Table 1. FDI committed and FDI implemented in the period 2007-2016**

Year	Number of Projects	FDI commitment (mil. USD)	% change FDI commitment (yoy)	% change FDI commitment (y/2007)	FDI implement (mil. USD)
2007	1544	21348.8	77.84%	-	8034.1
2008	1171	71726.8	235.98%	235.98%	11500.2
2009	1208	23107.5	-67.78%	8.24%	10000.5
2010	1237	19886.8	-13.94%	-6.85%	11000.3
2011	1186	15598.1	-21.57%	-26.94%	11000.1
2012	1287	16348.0	4.81%	-23.42%	10046.6
2013	1530	22352.2	36.73%	4.70%	11500.0
2014	1843	21921.7	-1.93%	2.68%	12500.0
2015	2120	24115.1	10.01%	12.96%	14500.0
2016	2556	24372.1	1.07%	14.16%	15800.1

Source: General Statistics Office of Vietnam.

Regarding to FDI by sectors, most of FDI in Vietnam has gone to labor intensive manufacturing, accounting for 58.8% of all FDI inflows in the period 2007-2016. As a result, Vietnam has emerged as global manufacturing and assembly hub, integrated in global supply chains. Most investments are focused on light industries such as computers, mobile phones and electronics. Especially, an increasing number of high technology through nations companies (TNCs) such as Samsung, Intel, Microsoft, Rockwell Automation... has invested and decided to expand operation in Vietnam (only Samsung has pledged up to more than 12 billion USD of investment to the end of 2015, with 3 projects in Bac Ninh, Thai Nguyen and Ho Chi Minh city). Besides manufacturing, the second-biggest recipient of FDI in Vietnam was the real estate sector, comprising for 17.7% of the total committed FDI in the period 2007-2016. It is notably that the high rate of investment in real estate construction sectors stimulated by the property market bubble has contributed to macroeconomic instability (Nga. T.N, 2011). In the “bubble period” from 2008-2011, nearly 50% of total FDI in Vietnam was invested in real estate sector, and the rate for 2016 was only 7%. The FDI movement from the speculative sectors like real estate to labor-intensive manufacturing sector is expected to be continued in the period 2016-2020 due to the orientation of the Vietnamese government.

**Fig.1. FDI by sector in the period 2007-2016**

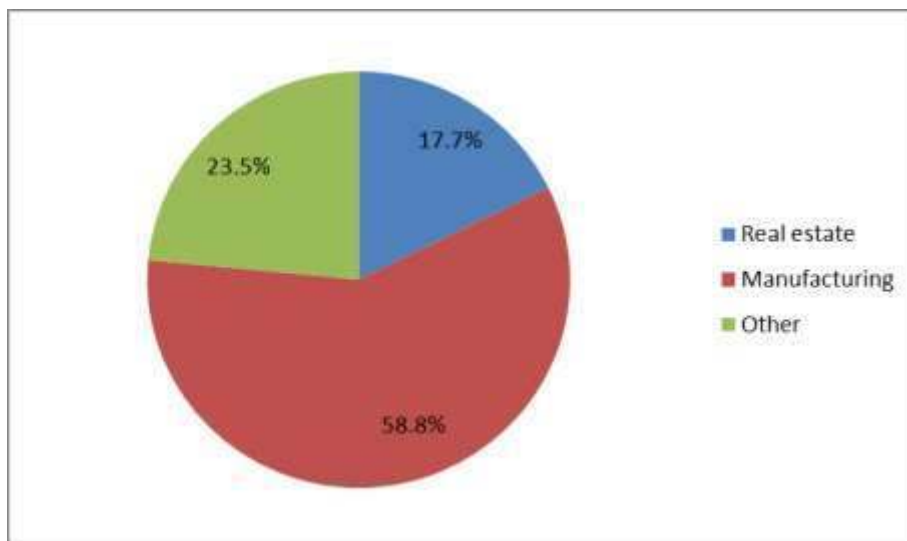

Source: General Statistics Office of Vietnam.

Regarding to FDI by sources, regional investors are the most active in Vietnam. Despite Vietnam is the host

country for 116 countries and territories worldwide, the majority of FDI in Vietnam has come from East Asia, in which Korea, Japan, Hong Kong, Taiwan accounting for nearly half (48.2%) of total FDI registered. ASEAN countries constituted around 20% of the FDI inflows. In which, Singapore (12.9%) and Malaysia (4.2%) are the two most active investors. However, FDI from the United States and Europe are moderate, only comprising less than 10% of the total FDI commitment. Notably, in the last three years (2014-2016), Korean investors was the most active one in Vietnam with 7.7 billion USD registered in 2014, 6.98 billion USD in 2015 and 7.04 billion USD in 2016, accounting for 35.1%, 28.9% and 29% of the total committed FDI respectively (FIA, 2017). The gradually movement from investors from China, Taiwan, Malaysia in the “bubble period” 2008-2011 to investors from Korea, Japan, Hong Kong and Singapore in the period 2012-2016 was an encouraging sign, which puts Vietnam to a higher level of the global value chains.

**Fig.2. FDI by countries and territories in the period 2007-2016**

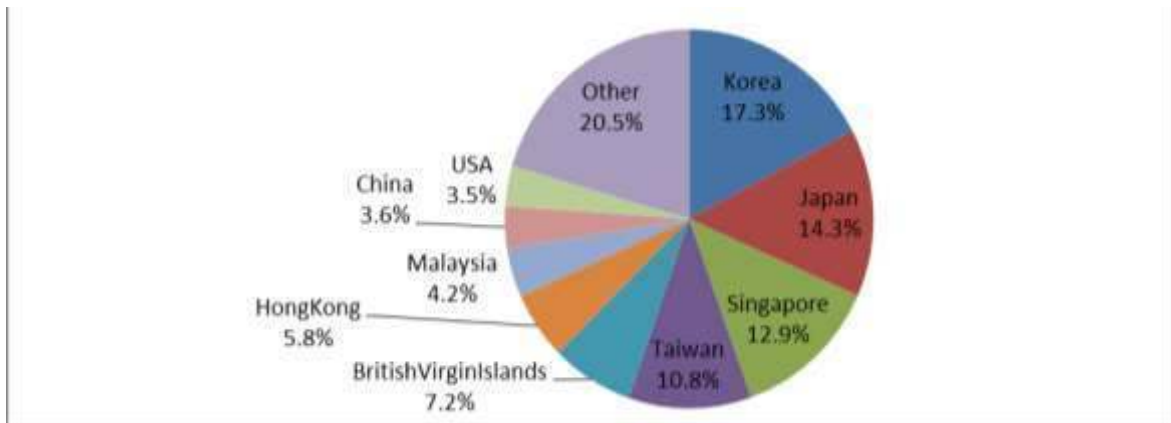

Source: General Statistics Office of Vietnam.

Regarding to FDI by regions, most of FDI has come to the South of Vietnam. In which, Ho Chi Minh city is the largest FDI recipient, accounting for 15.3% of total FDI commitment, followed by Ba Ria Vung Tau (9.2%), Binh Duong (9.1%) and Dong Nai (8.8%). Notably, in recent years, there has been a surge in FDI to the North of Vietnam, especially in Bac Ninh, Thai Nguyen and Hai Phong. However, a large number of provinces (34/63) have FDI stock comprised for less than 0.5% of total FDI committed. Especially, in 2016, 16 of 63 provinces had no new FDI projects. It means that many provinces in Vietnam are not active in attracting FDI, and still much rely on investment from the state budget.

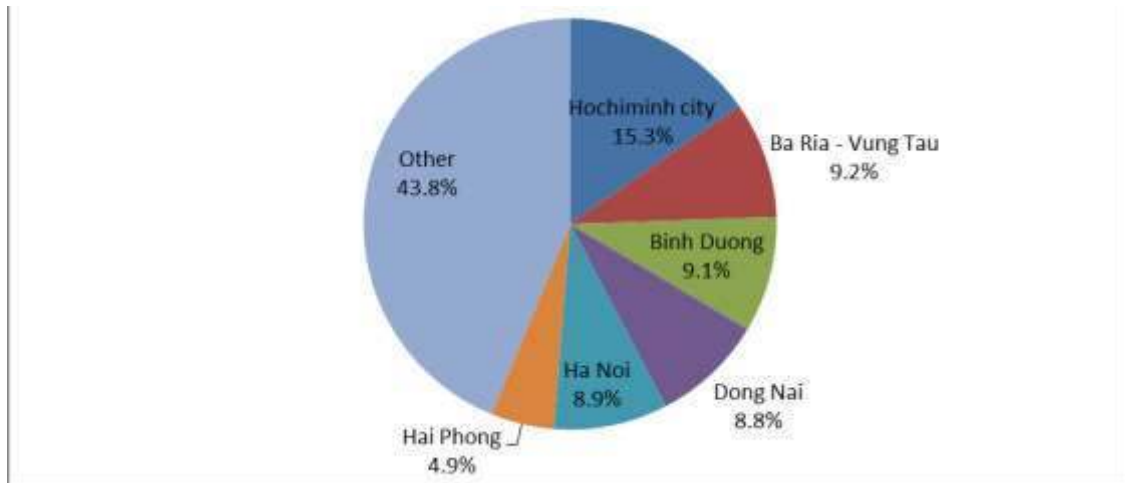

**Fig.3. FDI by regions in the period 2007-2016**

Source: General Statistics Office of Vietnam.

Regarding to FDI by forms, Most FDI in Vietnam are green field investments that are fully owned and operated by foreign investors. Foreign investors have overwhelmingly chosen to invest via 100% foreign-owned enterprises – currently accounting for 71.4% of all Vietnamese FDI projects. The high rate of 100% foreign FDI firms goes with a low level of knowledge and technology transfer. Vietnamese government encourages joint venture firms with horizontal FDI, to take the advantages of spillover effect of FDI firms for the domestic market. However, most of FDI so far (60%) is vertical FDI, mainly focus on labor-intensive production, with moderate level of value added. The imbalance of FDI by forms has raised the question of the role of FDI in transferring knowledge and technology for the domestic market.

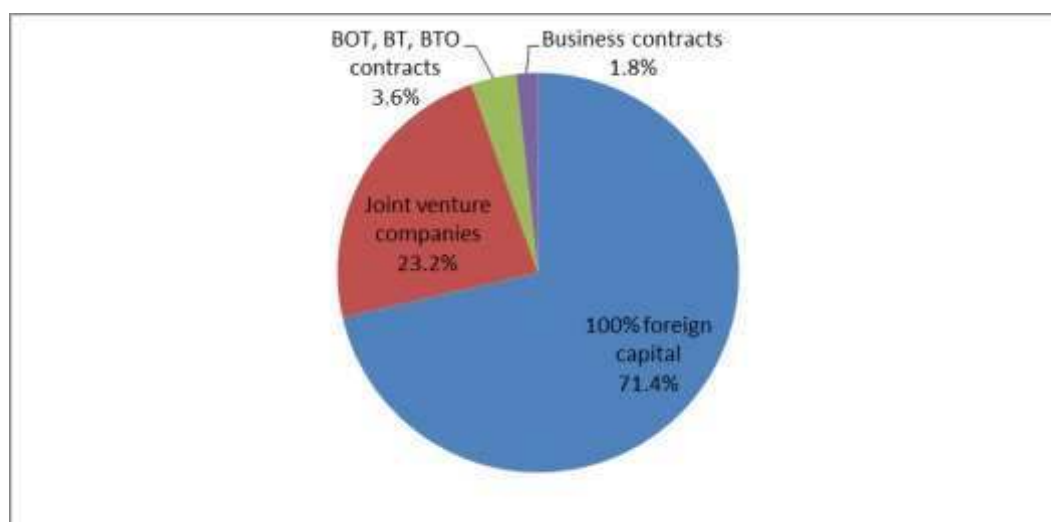
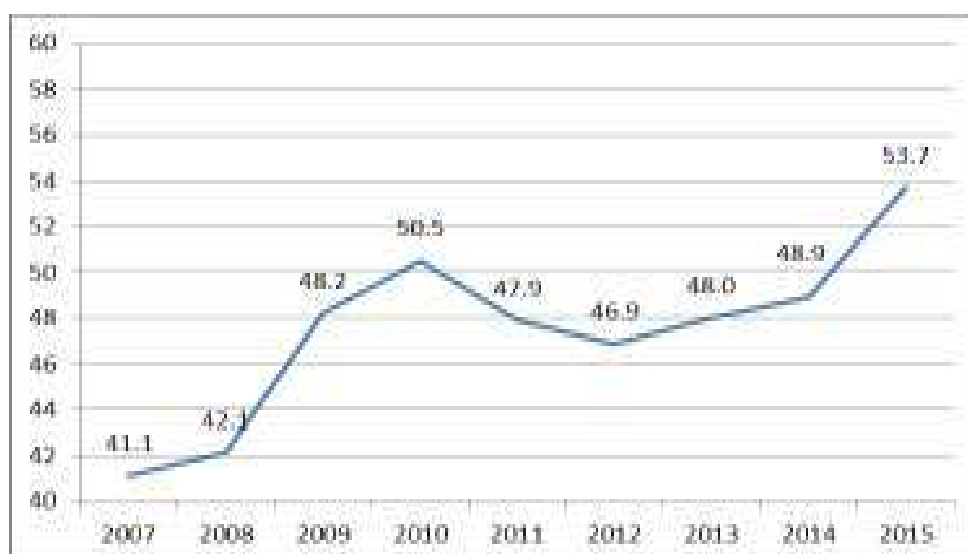

**Fig.4. FDI by forms in the period 2007-2016**

Source: General Statistics Office of Vietnam.

### 3. FDI in Vietnam after WTO's accession: achievements and challenges

FDI in Vietnam saw a big surge after the accession to the WTO. As a result, FDI sector has been a main engine for Vietnam's economic development. By the end of 2016, FDI firms created 3.9 million jobs, or 7% of the labor force. FDI sector also comprised for more than 20% of GDP and 25% of total investment in the period 2011-2016. The contribution of FDI for state budget has increased, reached 14.4 % in 2015, almost double 7.4% in 2005. Based on UNCTAD data, the FDI stock represented, on average, 47.5% of GDP during the period 2007-2015. In 2015, the FDI stock exceeded 50% of GDP, stood at 53.7% (fig.5). With a high level of integration to the global economy, it is expected that FDI will have stronger contribution for the economic growth of Vietnam in the upcoming years.



**Fig.5. FDI stock as a percentage of GDP in Vietnam in the period 2007-2015**

Unit: per cent.

Source: own calculation based on UNCTAD data.

FDI firms have, especially, played an increasing important role for trade performance. The contribution of FDI sector in Vietnam's total imports/exports remarkably increased (fig.6). Since 2007, the majority of Vietnam's total exports and imports were implemented by FDI sector. In 2015, the FDI sector accounted for 70.5% of Vietnam's total export, with a 25% growth over the last decade. With export-oriented manufacturing FDI sector, Vietnam's export composition has shifted from agricultural and primary commodities to labor-intensive manufacturing and hi-tech goods. FDI firms are the key exporters in smart phones (100%), electronics and computers (97%), vehicles and parts (93%), footwear (81%), luggage and bags (80%) and garment (60%) (World Bank, 2016). FDI sector also has boosted import activities, especially for machinery and equipment. In 2015, FDI sector comprised 58.7% of Vietnam's total import.

The strong export surplus of FDI sector has helped Vietnam to mitigate its trade deficit as well as contribute to Vietnam's macroeconomic stability.

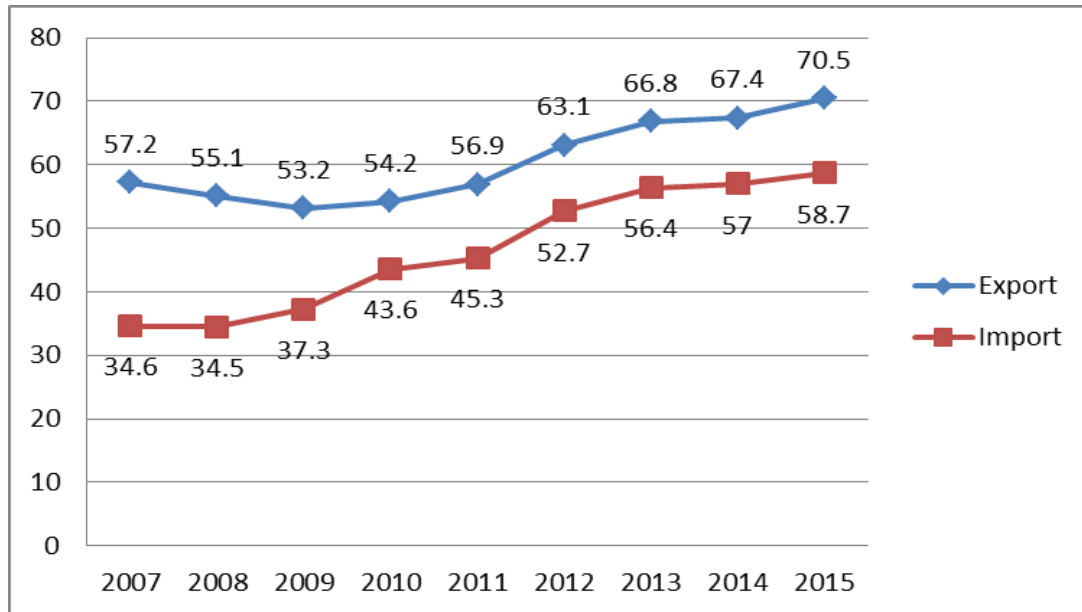

**Fig. 6. Share of FDI in Vietnam's exports-imports**

Unit: per cent.

Source: General Statistics Office of Vietnam.

However, FDI in Vietnam after WTO accession has experienced some difficulties. Many issues such as polluted environment, imbalance of FDI by sectors, imbalance of FDI by regions, lack of human resources, especially skilled workforce remain the “bottle necks” for FDI attraction in Vietnam. Besides these traditional issues, this paper focuses on analyzing two recent trends may negatively affect the sustainable of FDI in Vietnam.

Firstly, the spillover effect of FDI firms on domestic firms as suppliers remain relatively weak. On the other hand, there are domestic firms which are largely inward oriented and serving the domestic market. The linkages between these two segments are very limited. As such, the FDI sector operates in isolation rather than serving as a broader catalyst for growth, with limited spillovers to the domestic private sector in the form of increased demand for inputs, access to new technology and managerial techniques, demonstration effects and agglomeration benefits. The expanding labor-intensive manufacturing sector has not stimulated the development of supplier industries such as cotton and synthetic cloth, dyes, chemicals, plastics and steel. As the experience of Japan, Korea, Taiwan (China), Singapore, and now China shows, export value added can be enhanced through heightened technological intensity in exported products and services. These examples also show that an export model that is primarily based on low labor cost and labor intensive, low technology exports will ultimately diminish as wages inevitably rise (WB, 2016).

Secondly, there are an increasing number of FDI invested in Vietnam from tax-havens. In the last six years (2011-2016), there was a strong rise in FDI from countries and territories known as the ‘tax havens’ such as British Virgin Islands, Singapore, Hong Kong, Cayman, Bermuda, Panama, Jersey, Luxembourg, New Zealand, Bahamas, Panama, Delaware State in the US, Switzerland, and Ireland. In which, only Singapore, BVI and Hong Kong comprised for 26% of total FDI stock. Increasing of FDI from tax havens has raised the question about tax lost, which remains a controversial issue in Vietnam.

#### 4. Policy implications for “green” FDI in Vietnam

FDI has been a main engine for economic growth in Vietnam after the WTO accession. The increasing role of FDI in Vietnam is inevitable. However, to avoid the negative effect of FDI and towards sustainable or “green” FDI, the Vietnamese government should focus on solving the “bottle necks” on attracting FDI as well as reject unsuitable FDI projects.

First, Vietnam should strengthen the linkages between domestic and FDI enterprises. One of the basic solutions is paving the way for the development of supporting industries. At present, the supporting industries only meet about 30% of the demand of FDI enterprises, creating a large import pressure and reducing the linkage of domestic and FDI enterprises. Moreover, the development of supporting industries will also play an important role in helping Vietnam more integrated to the global value chain. Currently, there are only 21% of Viet Nam enterprises getting involved in the global supply chain, compared to Thailand (30%), and Malaysia (46%). So, Vietnam should complete many tasks to strengthen the integration of domestic goods and service suppliers.

Second, Vietnam should attract selective FDI which has high value-added, advanced technology and environmental friendliness. Vietnam needs to attract good investors, especially multinational corporations which have high level of corporate social responsibility. To do this, it is necessary to fulfil the legal system and policies related to investment, which have to be consistent, transparent, predictable and competitive with other countries. Furthermore, Vietnam should complete mechanisms and policies for attracting hi-tech projects; issue standards to limit and prevent FDI projects with low quality.

Third, Vietnam should be better in planning in many levels: General planning, sector planning and regional planning. The Ministry of Planning and Investment will coordinate with relative ministries and localities to propose comprehensive solutions to ensure the implementation of these plans, such as: infrastructure investment, electricity supply, material and human resources supply etc. Well organized planning will pave the way to attract worth FDI projects, suitable with the orientation of Vietnamese government.

Forth, it is crucial to implement investment promotion through investment funds, banks, financial companies, law firms, foreign consulting companies etc. These financial institutions are important partners which can strongly affect the investment decision of foreign investors. Beside, it should be focus on on-site investment promotion through solving the difficulties of existing investors. In particular, investment promotion should focus on good quality FDI projects which achieve the goal of sustainable economic development; eliminate the projects which have potential environmental damage and backward technology.

Fifth, it is necessary to continue to improve the quality of human resources. In the context of integration, FDI inflows are likely to increase sharply in the coming time, which put a higher pressure on human resources demand, especially skilled workforce. To welcome the flow of FDI in the context of the 4.0 industrial revolution, it is necessary to maximize effectiveness of the golden population structure and strengthen linkages between enterprises and training institutions. It can make businesses quickly recruit suitable employees, reduce training and re-training cost. Particularly, it is crucial to improve the quality of human resource demand forecasting. Reliable forecasting can help to reduce the cost of re-training as well as avoid wasting social resources.

## 5. Conclusions

Vietnam is one of the most dynamic and fast growing economies in the Asia Pacific region. Vietnam also has joined a wide range of free trade agreements such as Vietnam - Korea, Vietnam – EU, the ASEAN economic community (AEC) and RCEP etc.,. In this context, FDI into Vietnam is expected to increase rapidly with the rate of 10-15% annually over the next 5 years. After 10 years of WTO accession, FDI has played an important role for economic growth, job creation and trade balance improvement. However, the issues of transfer pricing, tax evasion and sector imbalance are limitations need to be solved in the coming years. In order to enhance FDI attraction while maintain macro economy balance, the Vietnamese government should issue policies to attract green, high-tech FDI and more active in investment promotion. Particularly, it is crucial to strengthen the linkage between domestic enterprises and FDI enterprises to integrate deeper in the global value chain.

## References

- [1] Guzowska M., Quang P.T., Foreign direct investment in Poland and Vietnam: a comparative analysis, “Studia i Prace” 2017, Vol.49, No.02, pp. 247-261.
- [2] Ministry of Planning and Investment, Foreign investment Agency of Vietnam website, visited 6th June 2017. <http://fia.mpi.gov.vn/Home>.
- [3] Ministry of Planning and Investment, Foreign investment Agency of Vietnam website, visited 6th June 2017. <http://fia.mpi.gov.vn/tinbai/5365/Diem-manh-trong-thu-hut-FDI-cua-Viet-Nam>
- [4] Ministry of Planning and Investment, General Statistics Office of Vietnam website, visited 6th June 2017. <https://www.gso.gov.vn>.
- [5] Nga T.N, Foreign Direct Investment in Real Estate Projects and Macroeconomic Instability, “ASEAN Economic Bulletin” 2001, Vol. 28, No. 1, pp. 74-96.
- [6] Vietnamnet, More capital from tax havens poured into Vietnam, visited 14 August 2016. <http://m.english.vietnamnet.vn/fms/business/161768/more-capital-from-tax-havens-poured-into-vietnam.html>
- [7] UNCTAD official data, country fact sheets, <http://www.unctad.org>.
- [8] UNCTAD, World Investment Report 2016, pp. 24-26.
- [9] World Bank, Taking stock: an update on Vietnam's recent economic developments, WB working paper 65938, pp 25-26.

International Conference For Young Researchers In Economics And Business, ICYREB 2017, October 30<sup>th</sup> 2017  
Da Nang, Vietnam

# Factors Affecting Financial Performance of Firms in Context of The Fourth Industrial Revolution: Evidence From Information and Communication Technology Companies Listed in The Vietnamese Stock Market

Nguyen Thanh Dat<sup>a</sup>, Ta Dinh Hoa<sup>b</sup> \*

<sup>a</sup> Faculty of Corporate Finance, Academy of Finance.

<sup>b</sup> Faculty of Foreign Languages, Academy of Finance.

---

## ABSTRACT

The Fourth Industrial Revolution, building on the fusion of digital, physical and biological technologies, internet of things and artificial intelligence, is taking place all over the world and having a strong impact on all aspects of socio-economic life. It is leading to a change in production methods and workforces, according to the directive. Vietnam's economy, currently the 32nd largest in the world measured by purchasing power parity (PPP), is one of the world's fastest growing economies. The main objective of this research is to study and measure the strength and the weakness of the financial performance and the internal factors affecting this performance of these companies, as well as discover the extent of the application of these companies to the principles of financial management, which aims mainly to develop financial performance in various economic units, through the use of financial analysis methods, especially the method of financial ratio analysis.

**Keywords:** firm's performance, factors, industrial revolution, ROE, technology

---

## 1. Introduction

In Germany, there are discussions about "Industry 4.0", a term coined at the Hannover Fair in 2011 to describe how this will revolutionize the organization of global value chains. By enabling "smart factories", the fourth industrial revolution creates a world in which virtual and physical systems of manufacturing globally cooperate with each other in a flexible way. This enables the absolute Historical Context 8 The Fourth Industrial Revolution customization of products and the creation of new operating models. The fourth industrial revolution, however, is not only about smart and connected machines and systems. Its scope is much wider. Occurring simultaneously are waves of further breakthroughs in areas ranging from gene sequencing to nanotechnology, from renewables to quantum computing. It is the fusion of these technologies and their interaction across the physical, digital and biological domains that make the fourth industrial revolution fundamentally different from previous revolutions. In this revolution, emerging technologies and broad-based innovation are diffusing much faster and more widely than in previous ones, which continue to unfold in some parts of the world. This second industrial revolution has yet to be fully experienced by 17% of world as nearly 1.3 billion people still lack access to electricity. This is also true for the third industrial revolution, with more than half of the world's population, 4 billion people, most of whom live in the developing world, lacking internet access. The spindle (the hallmark of the first industrial revolution) took almost 120 years to spread outside of Europe. By contrast, the internet permeated across the globe in less than a decade. Still valid today is the lesson from the first industrial revolution – that the extent to which society embraces technological innovation is a major determinant of progress. The government and public institutions, as well as the private sector, need to do their part, but it is also essential that citizens see the long-term benefits.

---

\* Corresponding author. Tel.: +84 988.476.772.  
E-mail address: taichinhdn.hvtc@gmail.com

We have yet to grasp fully the speed and breadth of this new revolution. Consider the unlimited possibilities of having billions of people connected by mobile devices, giving rise to unprecedented processing power, storage capabilities and knowledge access. Or think about the staggering confluence of emerging technology breakthroughs, covering wide-ranging fields such as artificial intelligence (AI), robotics, the internet of things (IoT), autonomous vehicles, 3D printing, nanotechnology, biotechnology, materials science, energy storage and quantum computing, to name a few. Many of these innovations are in their infancy, but they are already reaching an inflection point in their development as they build on and amplify each other in a fusion of Technologies across the physical, digital and biological worlds.

With the world standing on the brink of the Fourth Industrial Revolution, Vietnam is preparing for an incoming wave of new technologies believed to be fundamentally changing global production. The main objective of this research is to study and measure the strength and the weakness of the financial performance and the internal factors affecting this performance of these companies, as well as discover the extent of the application of these companies to the principles of financial management, which aims mainly to develop financial performance in various economic units, through the use of financial analysis methods, especially the method of financial ratio analysis. Measuring performance is very important because it builds on the results, make different decisions in economic units. According to (Benjalux Sakunasingha. 2006) performance measures are the life blood of economic units, since without them no decisions can be made. Financial performance Measure is one of the important performance measures for economic units. Financial performance measures are used as the indicators to evaluate the success of economic units in achieving stated strategies, objectives and critical success factors (Katja Lahtinen, p. 11, 2009).

## 2. Literature review

### 2.1. Firm performance

The problematic of “performance” is a constant of the present economic turmoil, but also an insufficiently explored one. The “performance” of an organization has a complex character and reflects a concrete image over the financial and economic situation of an analyzed company. Recent studies on this issue brought to the specialists’ attention the necessity of identifying an intelligent and performing information system in order to support the decision makers in the strategic management process.

While “performance” has been present in the economic and financial literature since 1960 being formulated through different criteria, both quantitative and qualitative, there is no concrete definition of the concept. Performance has evolved from 1990, in terms of necessities and requests, several definitions being established on the reason of the level of achievement of organizational objectives (Bourguignon, 1995), to a positive result of an action or success in a specific area as Niculescu (2005) pointed out, to the multidimensional goal or purpose of the activity as a reflection of an enterprise’s multiple goals (Jianu, 2007)

The performance of an organization remains a central challenge for management research. In many diagnosis analyses, built around the main object of activity, there are direct links to items of financial performance. However, comparative economic data are not always available and they are subjective during a performance assessment. Due to these considerations, a greater attention has been given in the last years to the financial performance which generated a big impact over the performance management system.

Majumder and Rahman (2011) advanced the idea that financial statements contain a wealth of information which, if properly analyzed and interpreted, can provide valuable insights into a firm’s performance and position on the market. Several studies that approach the performance issue at the microeconomic level prove the special importance of financial management aspects, on the improvement of which depend the outcomes and the companies’ competitiveness (Burja, 2011). What interests us in a particular way, taking into account the specific of economic activity is the financial performance, through which we understand the capacity of a firm to generate new resources from day to day operations in a certain period of time. Information regarding performance represents evidence about financial performance that are collected and systematically used. Evidence may relate to efficacy or effectiveness of activities in this case talking about outcomes, factors that may affect the results and measures that can be taken to improve financial performance.

Performance can be measured through several indicators or financial ratios. So far the literature has analyzed the performance of companies from various countries and economy sectors through different accounting – based measures with great impact including return on assets (ROA), return on equity (ROE) and gross profit margin (GPM) (Abu-Rub, 2011), net operating profitability (NOP) (Raheman et al., 2010), return on total assets (ROTA) (Deloof, 2003), return on invested capital (ROIC), return on assets (ROA) (Narware, 2010). Performance at microeconomic level has been studied depending also on liquidity such as current ratio and liquid ratio (Singh et al., 2008), risks factors identified through leverage (Weill, 2011) and cash flow per liabilities. Other researches highlight performance assessment expressed by earnings before interests and taxes (EBIT) or expressing it through economic value added (EVA), return on equity (ROE), operating profit margin (OPM) (Ryan, 2008).

Rees (1995) pointed out that in the financial analysis, the wide use of financial ratios is an answer to the high amount of data contained in a set of financial statements and to the issue of comparing companies of different sizes.

Financial ratios may be used individually or in groups, in order to compare companies among themselves or against industry benchmarks. In most cases, the result of such analyses depends to a high extent on the financial analyst's skills and expertise.

A performance measure to determine the financial state of a company should not be sensitive to the choices of accounting methods and procedures, but it must assess the current management decisions, the risks of investment decisions and not punish managers for circumstances that are beyond their control (Damodaran, 2002). Under these circumstances a better choice could be EVA or any other performance measure that would consider "adding" value through previous investments. Nevertheless, Han et al. (1999) concluded that ROE is often used in econometric analyses with financial data.

## 2.2. Dependent variable.

As a dependent variable used, we employed ROE, as we believed that it synthesizes best the concept of company performance if it is to synthesize it by means of one indicator only. Return on Equity is perhaps the most commonly used profitability measure (Bertoneche et al., 2001). Due to the data accessibility and the ease in being understood, as well as to the interest granted to this ratio by capital investors, we decided to apply ROE instead of EVA (Economic Value Added) in generating an econometric model to empirically investigate the relation between various ratios from the financial situation of a company and the performance thereof.

Return on equity reveals how much profit a company earned in comparison to the total amount of shareholder equity found on the balance sheet. A business that has a high return on equity is more likely to be one that is capable of generating cash internally. For the most part, the higher a company's return on equity compared to its industry, the better. One of the ways to measure the profit enjoyed by shareholders is by using return on equity (ROE) ratio, the reason is that ROE ratio is comparable between one companies to the other and can indicate the profitability of one industry with the other. (Helfert, 2001).

## 2.3. Independent variables.

### Firm Size

Earlier research papers such as Sharma and Kesner, (1996) Mitchell, (1994) strongly support the effect of firm size on business survival and variance in operating performance. They argue that firm size is a basis of competitive advantage in the sense that larger companies tend to be more efficient than their smaller counterparts and have better resources to survive economic downturns.

Opler and Titman (1993) argue that lost sales in the time of financial distress are not only a function of leverage but also a function of the firm's size. For instance small companies tend to have higher volatility of earnings in the sense that they are more affected by the competitor and customer driven losses in sales (Opler and Titman, 1993). On the contrary larger firms tend to be disciplined by manager driven reductions in sales and could well benefit from an event of financial distress caused by the economic contraction (Titman and Wessel, 1988).

Furthermore, Rajan and Zingales (1995) suggest that large firms are more diversified and less likely to experience bankruptcy. In addition, issuing equity or debt will incur less direct costs for them. Therefore, large firms will have higher leverage comparing with the small firms. On the other hand, small firms are likely to employ more short term debt and less long term debt. This is due to the shareholder-creditor conflict (Titman and Wessel, 1988, Michaelas et al., 1999). Rajan and Zingales (1995) find a strong positive relation between firm size and operating performance.

Vijayakumar and Tamizhselvan (2010) found a positive relationship between firm size and profitability. Papadognas (2007) conducted analysis on a sample of 3035 Greek manufacturing firms and revealed that for all size classes, firms' profitability is positively influenced by firm size. Lee (2009) examined the role that firm size plays in profitability. Results showed that absolute firm size plays an important role in explaining profitability. Amato and Burson (2007) tested size-profit relationship for firms operating in the financial services sector. With the linear specification in firm size, the authors revealed negative influence of firm size on its profitability. Amarjit et.al (2010) found no significant relationship between firm size and gross operating profit ratio. The study of Falope and Ajilore (2009) also found no significant variations in the effects of working capital management between large and small firms in Nigeria using a sample of 50 quoted companies.

### Growth.

According to Jovanovic (1982), firms that grow experience increasing profitability while those making losses contract and eventually exit the market. He argues that the size of the firm at each certain point in time is a distinct statistical predictor of its business survival. Bogner et al (1996) finds that firm do in fact adjust their sizes to different economic conditions. However, if there are costs associated with the actual size adjustment, the firms may find it optimal to partially adjust and then catch on gradually at a later stage to the initially desired size (Bogner et al., 1996). Frank (1988) suggests that the company's entry size is a good indicator on the future success. Also Frank (1988) finds that recent growth is a good signal of the firm's performance expectations and hence implies a positive correlation between firm's survival and recent growth



#### Leverage

According to Rajan and Zingales (1995), leverage can be defined as the ratio of total liabilities to total assets. It can be seen as alternative for the residual claim of equity holders.

Aquino (2010) studied the capital structure of listed and unlisted Philippine firms. His study showed that high debt ratio is positively associated with the firm's growth rate and profitability. Joshua (2005) research paper revealed significant relationship between the ratio of total debt to total assets and ROE. The results of Aivaziana et al (2005) examined the impacts of financial leverage on the investment decisions and found that this is a negative relationship. In another study, Ahna et al (2006) found that the negative impact of financial leverage on the investment in the unimportant sectors is much important than the key sectors. Results of Youmatelo (2012) show that financial leverage negatively affects the investment decisions and those companies with higher debts are less eager to invest in the capital assets.

#### Technological innovation

As described by Patel and Pavitt (1997), technology is one of the main sources of competitive advantage for a company. Within the same industry, companies with a technological edge tend to have better profitability as well as being faster in developing new product lines or other technological innovation.

According to numerous studies related to resource-based theory, such as Andersson (2003) and Gallon, Stillman and Coates (1995), technological innovation is at the core of the company's competitive capability. Gallon et al (1995) suggests it is the most important core asset. Hafeez, Zhang, and Malak (2002) attest that a company should develop its competitive edge in order to acquire long lasting competitive advantages. Companies need to be constantly aware of the changing environment while keeping and developing new technological capabilities in order to survive.

#### Tangibility

Tangible assets provide collateral to lenders in times of financial distress and act as security against debt. Tangible assets also represent protection to lenders against moral hazards resulted by the shareholder-creditor conflict (Jensen and Mekling, 1976). Therefore firms with the higher level of tangible assets are more likely to employ higher levels of leverage. According to Wessel and Titman (1988), Rajan and Zingales (1995) there is a strong negative relation between a firm's operating performance and tangibility but a positive association with long term debt. For instance, firms with relatively risky, intangible assets tend to borrow less than firms with safe, tangible assets. Also companies that secure their long term debt with tangible assets are in fact able to borrow at much lower interest rates than the ones with intangible assets (Bradley, Janell and Kim, 1984). In the event of financial distress intangible assets would be rather undervalued and are likely to sustain damage (Myers, 2001).

#### Current Ratio

Going further than the usually employed models which are supposing linear relations in only one sense, between ROE and various factors of financial ratios type, we will propose testing the hypothesis regarding the existence of non-linear relations between the financial ratios and ROE specific to various industries. According to Mramor and Marmor-Kosta ROE should rise fairly quickly, with the positive evolution of liquidity from zero until at some level of liquidity reaches a maximum level of ROE. ROE beyond that level starts to decrease slightly as the current liquidity continues to grow. Companies with low liquidity problems are estimated to meet its short term obligations, problems which have a negative impact on the rate of return. Once reached the optimum level of liquidity ratio, additional liquidity costs outweigh the benefits and the rate of return fades. In this case the function is estimated to have a quadratic form of logarithmic type as described before. (Mramor et al., 1997).

### 3. Analytical framework and research variables.

Following is the regression equation:

$$Y = \alpha + b_1X_{1it} + b_2X_{2it} + \dots + b_n X_{nit} + e$$

Where: Y: Dependent Variable,  $\alpha$ : Constant Coefficient.  $b_n$ : Regression Coefficient,  $X_n$ : Independent Variable, e: Error Term

$$ROE_{it} = \alpha + \beta_1 * SIZ_{it} + \beta_2 * GRO_{it} + \beta_3 * LEV_{it} + \beta_4 * INT_{it} + \beta_5 * TAN_{it} + \beta_6 * LIQ_{it} + \epsilon_{it}$$

With t: Time and i: Company

Where:

**ROE**: independent variable.

**SIZ**: size (total asset)

**GRO**: growth (log of revenues)

**LEV**: leverage ratio (debt/debt+equity)

**INT**: R&D, advertising and marketing expenses (intangibles)

**TAN**: tangibility (fixed assets/totals assets)

**LIQ**: Current ratio

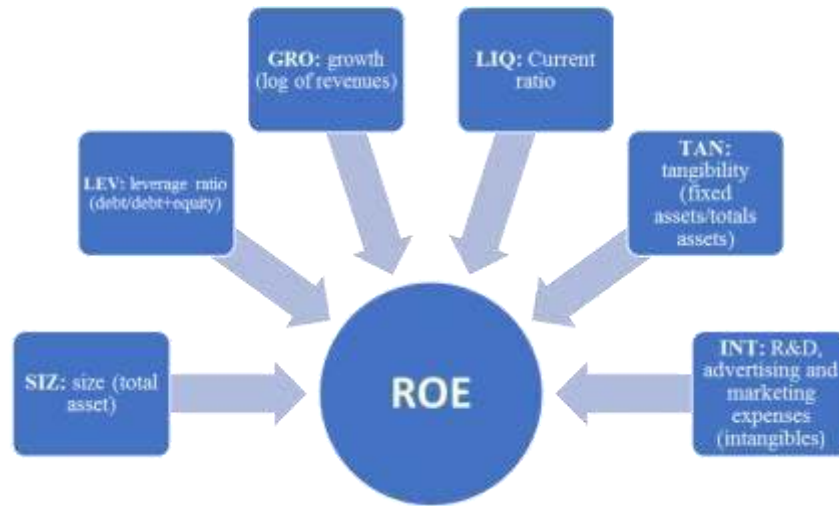

Figure 1: Conceptual framework of the study

4. Data collection

The present study mainly based on secondary data. Secondary data means is the data that have been already collected by and readily available from other sources. In order to make data consistency the data for this study was collected from the financial statements of firms listed on the Vietnamese Stock Market during the study period, namely the balance sheet and income statement from 2013 to 2017.

5. Result

5.1. Descriptive Statistics.

Table 1: Data descriptive statistics results for all variables

	GRO	INT	LEV	LIQ	ROE	SIZ	TAN
Mean	5.434965	49183.16	44.05087	2.062733	3.322919	3606900.	0.164326
Median	5.368326	13306.00	47.92000	1.610000	2.470000	433523.0	0.155731
Maximum	7.194632	456221.0	76.94000	7.600000	18.72000	29912454	0.411359
Minimum	2.864511	1.000000	7.120000	1.020000	-5.760000	74285.00	0.025576
Std. Dev.	0.967545	96296.08	16.47594	1.163071	4.654569	7153960.	0.086454
Skewness	0.254627	2.504689	-0.436823	2.416346	1.014437	2.331091	0.772471
Kurtosis	2.264489	8.042623	2.307979	9.219725	4.061644	7.137492	3.038824
Jarque-Bera	5.368783	338.9178	8.332762	416.1842	35.17461	260.6508	16.02185
Probability	0.068263	0.000000	0.015508	0.000000	0.000000	0.000000	0.000332
Sum	875.0293	7918489.	7092.190	332.1000	534.9900	5.81E+08	26.45654
Sum Sq. Dev.	149.7831	1.48E+12	43433.05	216.4376	3466.402	8.19E+15	1.195881
Observations	161	161	161	161	161	161	161

Descriptive studies produced the mean, minimum, maximum and standard deviation for each variable of information and communication technology firms listed on the Vietnamese Stock Market during 2013- 2017. Based **Table 1** the mean value of return on equity (ROE) is 3.322919% and the value of maximum is 18.72 %, it means that firm performance of these firms show good during the period. The mean value of Current ratio (LIQ) is 2.062733 and the value of standard deviation is 1.163071. The mean value of Log of revenue (GRO) is 5.434965 with the standard deviation is 0.967545. The mean value of Leverage ratio (LEV) is 44.05087% with the standard deviation is 16.47594. The mean value of Tangibility (TAN) is 0.164326 with the standard deviation is 0.086454. The mean value of Total asset (SIZ) is 3606900 million VND with the standard deviation is 7153960. The mean value of Intangibles (INT) is 49183.16 with the standard deviation is 96296.08.

**5.2. Regression estimate**

**Table 2: Multiple regression analysis**

Dependent Variable: ROE  
 Method: Least Squares  
 Date: 08/18/17 Time: 12:18  
 Sample: 1 161  
 Included observations: 161

Variable	Coefficient	Std. Error	t-Statistic	Prob.
C	-13.06146	3.037943	-4.299443	0.0000
GRO	3.618114	0.515700	7.015928	0.0000
INT	-3.32E-05	8.55E-06	-3.881707	0.0002
LEV	-0.045460	0.040491	-1.122710	0.2633
LIQ	-0.246777	0.528459	-0.466974	0.6412
SIZ	2.69E-07	1.30E-07	2.071947	0.0399
TAN	-0.656041	3.731973	-0.175789	0.8607
R-squared	0.423154	Mean dependent var		3.322919
Adjusted R-squared	0.400679	S.D. dependent var		4.654569
S.E. of regression	3.603371	Akaike info criterion		5.444122
Sum squared resid	1999.580	Schwarz criterion		5.578096
Log likelihood	-431.2518	Hannan-Quinn criter.		5.498521
F-statistic	18.82817	Durbin-Watson stat		1.715754
Prob(F-statistic)	0.000000			

Return on equity (ROE) is a dependent variable. Results show that the variables of Log of revenue (GRO) and total asset (SIZ) are positive related with return on equity (ROE). While the variables of current ratio (LIQ), Leverage ratio (LEV), Tangibility (TAN) and Intangibles (INT) are negative related with return on equity (ROE). The significant coefficients are as follows: Coefficient of Log of revenue (GRO) is 3.618114 indicating that when the revenue increases ten times with the assumption that other variables remain constant, then the return on equity (ROE) will increase by 3.618114 percent. Coefficient of Total asset (SIZ) is 2.69E-07 indicating that when Total asset (SIZ) increases by 1 million VND with the assumption that other variables remain constant, then the return on equity (ROE) will decrease by 2.69E-07 percent. The model identified for the variables studied is as follows:

$$ROE = -13.06146 + 3.618114 * GRO - 3.32E-05 * INT - 0.045460 * LEV - 0.246777 * LIQ + 2.69E-07 * SIZ - 0.656041 * TAN$$

**Table 3: Result of testing effect of factors to ROE**

Factors	Affecting to ROE
Log of revenue (GRO)	Positive
Leverage ratio (LEV)	Negative
Total asset (SIZ)	Positive
Intangibles (INT)	Negative
Current ratio (LIQ)	Negative
Tangibility (TAN)	Negative

**6. Discussions and conclusions**

The importance of analyzing performance ratios, to make comparisons with the companies from the same field of activity, to detect new tendencies and to make profitable changes require the use of advanced specific tools for multidimensional analysis, equipment’s performance, qualified personal for interpreting the analysis and the strengths to take important decisions for the prosperity of the company.

The classifications made in this study and the econometrical model can identify certain performance indicators useful for any financial and economic performance analysis of the companies. The regression model obtained in the paper reflects the relationship between the return rate ROE and principal influence factors belonging to the growth dynamic, as well as factors related to liquidity and risk. Other important factors such as R&D Expenses/Total SG&A Expenses or Price/Book ratio might be involved in a future econometric model to observe more complex relationship

## References

- [1] Amalendu, B. (2010). Financial Performance of Indian Pharmaceutical Industry: A Case Study. *Asian Journal of Management Research*, ISSN 2229 – 3795.
- [2] Benjalux, S. J. (2006). An Empirical Study into Factors Influencing the use of valueBased Management Tools, Ph D, Thesis, Southern Cross University
- [3] Bertoneche, M., Knight, R. (2001). “Financial Performance Butterworth- Heinemann”, Oxford
- [4] Boldeanu, D. (2008). “Information system for the analysis and assessment of the economic and financial performances at microeconomic level”, PhD thesis, Bucharest Academy of Economic Studies
- [5] Bourguignon, A. (1995). “Peut-on definir la performance?”, *Revue Francaise de Comptabilite*, 269:61-66
- [6] Burja, C. (2011). “Factors Influencing The Companies’ Profitability”, *Annales Universitatis Apulensis Series Oeconomica*, 13(2)
- [7] Damodaran, A. (2002). *Investment valuation – tools and techniques for determining the value of any asset*, 2nd Edition, John Wiley & Sons Inc.
- [8] Deloof M. (2003). “Does Working Capital Management Affect Profitability of Belgian Firms?”, *Journal of Business&Accounting*, vol. 30, issue 3-4
- [9] Jianu, I. (2007). *Evaluarea prezentarea și analiza performanței întreprinderii*, Editura CECCAR, București
- [10] Katja, L. (2009). *Assessing the resource usage decisions and financial performance in Finnish sawmills within the resource-based view framework*. Faculty of Forest Sciences, University of Joensuu, Finland.
- [11] Majumder, T.H., Rahman, M.M. (2012). “Financial Analysis of Selected Pharmaceutical Companies in Bangladesh”, *European Journal of Business and Management*
- [12] Narware, P.C. (2010). “Working Capital Management: The Effect of Market Valuation and Profitability in Malaysia”, *International Journal of Business and Management*, vol. 5, issue 11
- [13] Niculescu, M. (2005). *Diagnostic financiar*, vol II, Editura Economică, București, p. 42
- [14] Raheman, A., Afza, T., Qayyum, A., Bodla, M.A. (2010). “Working Capital Management and Corporate Performance of Manufacturing Sector in Pakistan”, *International Research Journal of Finance and Economics*, issue 47.
- [15] Ryan, K. (2008). “Financial leverage and firm value”, Gordon Institute of Business Science, University of Protoria
- [16] Singh J. (1986). Performance, slack, and risk taking in organizational decision making. *Academy of Management Journal* 29, 562-585.
- [17] Weill, L. (2011). “Leverage and Corporate Performance: A Frontier Efficiency Analysis”, 12th Symposium on Finance, Banking, and Insurance, Karlsruhe Institute of Technology (KIT), Germany, available on-line at <http://www.fbv.kit.edu/symposium/>

International Conference For Young Researchers In Economics And Business, ICYREB 2017, October 30<sup>th</sup> 2017  
Da Nang, Vietnam

# A Study on Qualitative Characteristics of Accounting Information: The Case of New Accounting System for Small and Medium Sized Enterprises in Vietnam

Nguyen Thanh Hieu<sup>a</sup>, Ha Thi Phuong Dung<sup>a</sup>, Nguyen Huu Anh<sup>a\*</sup>

<sup>a</sup>School of Accounting and Auditing, National Economics University, Hanoi, Vietnam

---

## ABSTRACT

When Vietnam enters Free Trade Agreement, Vietnamese enterprises face strong competition from other enterprises in the world. This is also an opportunity for Vietnamese enterprises to expand their markets and increase capital. Small and Medium Sized Enterprises (SMEs) in Vietnam accounted for about 98% of the total number of enterprises, contributed over 40% of GDP to the country, played a very important role in the economy. Therefore, the Government of Vietnam has introduced many economic policies, accounting policies supporting SMEs to develop. Recently, on August 26, 2016, the Ministry of Finance has issued a new accounting system for SMEs, Circular 133/2016/TT-BTC replacing Decision 48/2009/QĐ-BTC. Therefore, this paper aims to analyse changes in Circular 133/2016/TT-BTC and examine how those innovations in the new accounting system have contributed to the qualitative characteristic of accounting information. The results of this article contributed to Ministry of Finance to improve quality of accounting information for SMEs.

**Keywords:** Circular 133/2016/TT-BTC, SMEs, accounting information

---

## 1. Introduction

SMEs in Vietnam accounted for about 98% of the total number of enterprises operating in the country, of which the number of medium-sized enterprises only accounted for 2.2%, small-sized enterprises accounted for 29.6% and the remaining 68.2% for super small-sized enterprises (Do Anh Tuan, 2016). Not only Vietnam, many countries in the world including developed countries, the role of SMEs is still highly appreciated. SMEs create over one million new employees each year. Accounting is the tool for management of SMEs that provide extremely useful information to managers, investors, and governments. Good quality of accounting information will lead to good quality of management decisions and investment decisions. The demand for good quality of accounting information has been confirmed in the International Accounting Standards Board and the US Accounting Standards (Obaidat, Ahmad N., 2007). The primary objective of financial reporting is to provide useful information to interested parties. This information should have qualitative characteristics to be useful for decision making. The characteristics can be view as a hierarchy of qualities as shown in Figure 1. Relevance and reliability are two primary qualities that make the accounting information useful for decision making. If either is missing completely from a piece of information, the information will not be useful. Other qualities include comparability, consistency, and cost-benefit relationship.

---

\* Corresponding author. Tel.: +84983665165  
E-mail address: hieu39ktqd@gmail.com

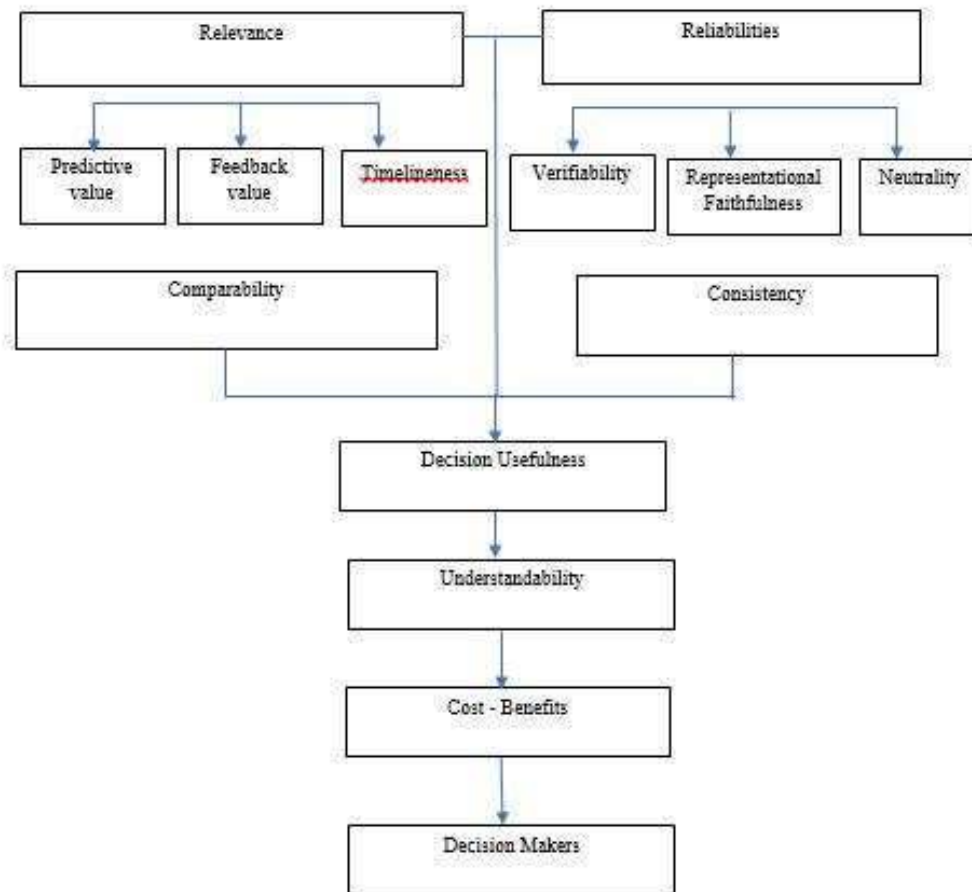

(Source: Obaidat, Ahmad N., 2007)

**Figure 1: Qualitative characteristics of accounting information for decision maker**

#### Relevance

To be relevant, accounting information must be capable of making a difference in a decision. Relevant information should have predictive value, feedback value and timeliness. Relevant information helps decision makers predict the future, it has “Predictive value”. Relevant information also helps decision makers correct prior expectations; it has “Feedback value”. In addition, to be relevant, information must be timely or “Timeliness”. The information must be available to a decision maker before it loses its capacity to influence decisions.

#### Reliability

To be reliable, accounting information permits users to use with confidence. Representational faithfulness refers to agreement between a measure and the events that it purports to represent. Verifiability refers to the ability, through consensus among measures, to ensure that information represents what it purports to represent or that the chosen method of measurement has been used without error or bias. Neutrality means that, formulating or implement has been used without bias.

#### Consistency

Consistency means that the enterprises conform accounting policies and procedures from period to period without any changes. Conformity can be reached by applying the same accounting method to similar events. It does not mean that an enterprise can’t switch from one accounting treatment to another if the enterprise disclosed fully the reasons and the effect of such change.

#### Comparability

Comparability results when different enterprises apply the same accounting treatment to similar events. Enterprises applying standards complied with international accounting standards helps to enhance comparability. Accounting information is extremely useful if it can be compared to accounting information about other enterprises.

#### Relationship Cost & benefit

The cost of providing the information should be weighed against the benefits of using the information. Cost-benefit decisions are extremely difficult because both cost and benefits are often subjective and difficult or impossible to measure reliably.

In the next section, this paper will cover the following topics: (1) An overview of the new features in accounting system for SMEs under Circular 133/2016/TT-BTC; (2) research method; (3) research results; (4) Discussion of

research results, recommendation and conclusion.

## **2. An overview of new features in accounting system for SME under Circular 133/2016/TT-BTC**

### **2.1. Accounting vouchers**

Under Circular 133/2016/TT-BTC, accounting vouchers is no longer mandatory template, all forms are manual. Enterprise can use the form available or self-designed. The design of documents must comply with general principles.

### **2.2. Account**

#### 2.2.1. Remove some accounts

- 111 (3) and 112 (3): Gold, silver and gemstones
- 142: Short-term prepaid expenses
- 159: Provisions
- 171: Government bond repo transaction
- 221: Long-term financial investment
- 244: Long-term deposits, mortgages and collateral
- 311: Short-term loan
- 315: Current Maturities of Long-term debts
- 3413: Issuance of Bonds
- 351: Reserve fund for unemployment
- 0: Off - balance sheet accounts

#### 2.2.2. Add some accounts

- 128: Investments held to maturity: 128 (1) Deposits and 128 (8) Other investments
- 136: Inter-company receivables
- 1386: Pledge, mortgage, collateral
- 151: Goods in transit
- 228: Investment in other entities (2281: Investment in joint-venture, associate 2288: Other investment)
- 336: Inter-company payables
- 356: Science and Technology Development Fund
- 41111: Common shares
- 41112: Preferred shares

#### 2.2.3. Edit some account names

- 121: Trading Securities (previously known as Short-Term Investment)
- 229: Provision (previously known as Provision for Long-term Investment Loss). 2291: Provision for trading securities, 2292: Provision for loss of investment in other entities; 2293: Provision for bad debts, 2294: Provision for devaluation of inventories
- 242: Prepaid expenses (previously known as long-term prepaids)
- 3338: Environmental Protection Taxes and Other Taxes (previously known as Other Taxes)
- 341: Borrowings and financial liabilities (previously known as long-term loans). 3411: Loans; 3412: Financial lease
- 411: Owner's capital (previously known as business capital)
- 4111: Contributed capital by the owner (previously known as the owner's capital)
- 421: Undistributed earnings (previously known as retained earnings)

### **2.3. Changes in accounting method**

#### 2.3.1. Accounting for Trading securities

Recognition of income, expenses from trading securities record into Account No 515 "Finance Income" (if gain) or Account No.635 (if loss). If receiving stock dividends, enterprises only track the number of shares on the explanation, no entry need in this case. At the end of accounting period, if market price of trading securities go down lower than cost, then SMEs make provision for that reduction. When liquidating or selling trading securities, the cost of trading securities is determined on a weighted average or first-in, first-out basis.

### 2.3.2. Accounting for sales

#### Method for calculating ending inventory

To determine value of inventory at the end of the period, retail price method can be applied to some specific units and some kinds of business such as supermarket or similar. This is supplement for existing method to estimate cost flow.

When SMEs provide goods free of charge and without other conditions such as the need to buy goods for customers, SMEs record in to promotional expenses account, or advertising expenses account. Previously, in Decision 48/2006/QĐ-BTC, accounts recorded both revenue and cost of goods sold for advertising goods though in reality enterprises do not receive money as well as receive any direct economic benefit from those goods offered.

When implementing advertisement with conditions such as buying goods (buy 2 get 1 free), SMEs record in the cost of goods sold the total value of goods transferred (including goods sold and goods for promotion) but accountants record sales only based on goods sold).

Promotional goods that the SMEs received from producers are not recognized as inventories (assets). Those goods will be separately tracked on financial statement notes. At the end of the promotion campaign, if the goods are not returned to the producers, then the goods are recognized as other income in the income statement. Previously in Decision 48/2006/QĐ-BTC

### 2.4. Preparation financial statements

Circular 133/2016/TT-BTC details the principles for making and presenting financial statements for each specific situation: SMEs meet and not meet the assumption of going -concern assumption; Change the accounting period; Change in ownership; Re-organize the business; Change the accounting currency.

### 3. Research Method

In order to obtain the opinions of the subjects using accounting information related to the Ministry of Finance has just issued the new accounting system for SMEs, the author conducted in-depth interviews with 3 groups as follows:

Group 1: Experts working in State management agencies

Group 2: Accountants working for SMEs

Group 3: Auditors and certified public accountants and lecturers who teach Accounting at Universities in Hanoi.

Group 1 consists of 2 persons, Group 2 consists of 9 accountants working in manufacturing, Merchandising and Service Enterprises in Hanoi, Group 3 includes 10 peoples (5 auditors, CPA working in AASC, Grant Thornton and UHY auditing firms in Hanoi and 5 lecturers from National Economics University, Banking Academy and Trade Union University).

The interviewees will answer the questions aimed at assessment of the effects of the issuance of Circular 133/2016/TT-BTC on the quality of accounting information (relevance, reliability, consistency, comparability, cost-benefit relationship of accounting policies). Questions are designed in two parts: Part 1 includes questions about the interviewees' perceptions of changes in Circular 133/2016 compared to Decision 48/2009; Part 2 includes discussion questions on comments on Circular No.133/2016 to improve the accounting qualities for SMEs in Vietnam.

Part 1: Assessment of changes in the accounting system for SMEs in Circular 133/2016 compared to Decision 48/2009

Q1. What do you think about the changes in Account No.521 "Sales returns and allowances" compared to Decision 48/2006?

Q2. What do you think about the changes in Account No TK 343 "Issuance of bonds" compared to Decision 48/2006. When the company issued the bond, how will SMEs handle it?

Q3. What do you think when Circular 133 is no longer consider gold, silver, gemstones as a means of storing value. Gold, silver, gemstones are no longer categorized in the cash and cash equivalent section of balance sheet as previously in Decision 48/2006?

Q4. What is your opinion when Circular 133 removed the off-balance sheet account compared to Decision 48/2006?

Q5. What is your comments when Circular 133 added investment: "Trading securities" and "investment held to maturity" compared to Decision 48/2006?

Q6. What is your opinion when Circular 133 create a new account "Provision for investment loss in other entities" compared to Decision 48/2006?

Q7. What is your comments when Circular 133 give details to "Provisions for contingencies and other liabilities" compared to Decision 48/2006?

Q8. What is your opinion when Circular 133 added inter – company receivables and inter – company payables (Accounts No.136 and Account No.336) compared to Decision 48/2006?

Part 2: Other comments to improve the SME Accounting System



Q1. Should Circular No.133 separate selling expenses account and general administrative expenses account?

Q2. Should Circular No.133 add more details in Account No. 418 "Other owners' equity"?

Q3. What is your opinion on revaluation of assets at fair value?

Q4. Has the information on the financial statements under regulation of Circular No.133/2016 been presented fairly yet?

Q5: Other comments?

#### **4. Research results**

##### **4.1. Assessment of experts working for State management agencies on Circular No.133/2016/TT-BTC**

According to Ms. Tang Nguyet Anh from Business Registration Administration, Vietnam:

Ms Tang Nguyet Anh said: Circular 133/2016/TT-BTC was considered to be open, highly flexible and offered many options for SMEs. SMEs are self-detailed content of accounts (short-term, long-term) depend on management requirements. SMEs will be able to build its own vouchers and accounting treatment to meet the administrative and operational requirements appropriate to its operations as long as it meets the requirements of the Accounting System. Moreover, accountants in SMEs do not need to specify the journal entries, they can make their own accounting entries to best suit their documents and habits as long as the financial statements are properly reported. The new circular also provides flexibility for SMEs to choose their own accounting currency when meeting regulatory criteria. In addition to that, SMEs can decide whether or not to record revenues from internal transactions without depending on the kind of documents available at the date of delivery goods are the VAT invoices or delivery notes. SMEs have rights to choose accounting treatment for the capital received from internal as internal payable or contributed capital. SMEs can choose the form for reporting financial statements in order of liquidity or in order of short-term and long-term.

Mr Trinh Duc Vinh - Deputy Director of Accounting and Auditing Policy Department, Ministry of Finance commented

Mr Trinh Duc Vinh commented on Circular 133/2016:

Firstly, the accounting systems applicable to SMEs issued in accordance with Decision 48/2006/QĐ-BTC has been existing for 10 years and revealed some limitations and needs to be changed. The new accounting systems for SMEs under Circular 133/2016 is based on the Accounting System for big enterprises issued in Circular 200/2014/TT-BTC with amendment and adjustments for simplicity.

Secondly, there are a lot of innovations in the accounting system for SME and one of the main points is to put the enterprises development in the central of policy rather than state governance. Accounting will be separated from taxes. Moreover, it is the first time the Accounting system for SMEs has strong statement about the difference between accounting income and taxed income.

Thirdly, the accounting system for SMEs is open, flexible and offers many options for businesses. The accounting system mainly regulates to account level 1, only a few accounts detailed to level 2, each account only reflects one content. Circular 133/2016 has not separated short-term and long-term accounts. The enterprise is self-detailed and follow short-term, long-term or open detailed accounts according to their management requirements; Removal of all mandatory documents and accounting books. SMEs will be able to design their own voucher and accounting treatment to meet enterprise's operation requirements as long as they do not violate the regulations specified in Accounting System for SMEs. The new accounting system only regulates accounting principles rather than regulates detailed accounting entries for each transaction. By applying accounting principles, SMEs will be able to make their own accounting entries that best match their documents and habits as long as the financial statements are properly disclosed. SMEs can decide whether or not to record revenues from internal transactions no matter what kind of document issued VAT invoices or delivery notes. SMEs have rights to treat the capital received from internal as internal payable or owner's contributed capital. SMEs can choose the form for reporting financial statements in order of liquidity or in order of short-term and long-term.

##### **4.2. Assessment of accountants working in SMEs**

Circular 133/2016 added tracking inter-company accounts receivable, inter-company payables (Account 136 and Account 336). Now, SMEs tend to co-operate with big companies to become Group of parents and son. As the result, Group must prepare the consolidated financial statements. The separation of receivables, payables internally will help to make the consolidated financial statements become effectively and bring accurate and useful information to the users of accounting information.

Circular 133/2016 added investment accounts: Trading securities and investment hold to the maturity reflected the purpose of holding assets of SMEs and the nature of transaction. In addition, the different accounting treatments for holding and trading securities to the maturity date makes accounting information more reliable.

Circular 133/2016 details the contents of Account No. 352 "Contingencies Liabilities" into sub-items such as: Contingencies liabilities for goods, Contingencies liabilities for construction works or other payables, therefore,

presentation of the accounting information faithfully. However, the accountants admitted that they still face difficulties while estimating contingencies liabilities.

Circular 133/2016 has not regulated gold, silver, gemstones as means of storing value, as well as categorized in cash and cash equivalent section in balance sheet as previously Decision 48/2006. This is reasonable because when making payment for purchasing goods SMEs must sell gold, silver, precious stones to get money and then give to suppliers. So, gold, silver, gemstones are considered like commodities rather than currencies.

Account 521 "Sale returns and allowances" was removed from Chart of Account in Circular No.133/2016. According to SMEs accountants, removing Account 521 is appropriate because SMEs only pay attention of the net cash inflow when they sell goods rather than gross sale and sale returns and allowances. Moreover, sale invoices issued by SMEs always base on the net amount after taking account for deductions and allowances. Thus, using account number 521 "Sale returns and allowances" in Decision 48/2006 is superfluous, unnecessary.

When asked about the rationale that account No. 418 keeps track of all owners' equity of the business? The accountants commented: There is no need to detail Account No.418 because SMEs only operate in a market sensation, with no long-term development goals. Profit after tax immediately supplemented to the contributed capital to increase capital to be eligible for bank loan contract. The amount left after dividend payment will be spent to set up welfare fund to encourage employee rather than set up for other funds.

#### **4.3. Assessment of auditors, certified public accountant and lecturers**

Circular No.133/2016 did not consider gold, silver, gemstones as a means of storing value is not reasonable because SMEs can still use gold, silver and gemstones as convenient tools for payment. Removing gold, silver, gemstones from the list of cash and cash equivalents will make the cash and cash equivalent of SMEs presented under their value.

Circular No.133/2016 removed Account 521 "Sales returns and allowances". Therefore, when revenue reductions occur, accountants must write directly down to Account No. 511 "Sales Revenue" which causes accounting information to be less honest when it does not specifically reflect the reduction in sales. Moreover, it caused difficult for managers to evaluate the effectiveness of sale policies.

Income, Expenses and operating performance of enterprises are the center of attention of accounting information user. Therefore, in this Circular 133/2016, auditors found that the revenue was accurately reflected and the expenses was also fully reflected. In recognition of revenue, Circular 133/2016 issued a new regulation stipulating that value of advertising and promotional products will not be recognized as revenue, in contrast, the value of goods offered as promotional products are treated as promotion expenses; SMEs can choose when to record internal sales: at the time delivery goods to subsidiaries or at the time the subsidiaries sold goods to customers. In recognition the costs, the SMEs recognizes the costs incurred on the accrual basis when that expense occurs. This makes accounting information accurately reflect performance of the business and so it can be said that accounting information has a predictive value.

Circular 133/2016 has no longer use Account No.343 "Bond issuance" that existed in Decision 48/2006. So, once the enterprises issue bonds, enterprises record value of bond issued in Account No.341 "Borrowings and finance lease". The discount or premium arising when issuing bonds will not be reflected separately, so the accounting information when issuing bonds will be blurred and less useful for decision makers.

The addition of Accounts No. 136 "Inter-company receivables", Account 336 "Inter-company payables", details the contents of "Short-term investment" in Decision 48/2006 to "Trading securities" and "Investment held to maturity" or details of Account No. 352 "Contingencies payable", Account No. 151 "Goods in transit" are remarkable reforms of the new accounting system, which increases the transparency of accounting information.

### **5. Discuss the research results and propose some solutions to improve qualitative characteristic of accounting information**

#### **5.1. Discussion of research results**

After conducting interviews with 3 groups, though there are some disagreements among groups about new accounting system for SMEs in Circular 133/2016, qualitative characteristic of accounting information that the new accounting system brought can be summarized as follows:

Reliability: All groups of interviewees agreed that Circular 133/2016 helps accounting information to be presented honestly and objectively. The new regulations allow the recognition of the value of the goods in transit, which accurately reflects the value of the inventory. In addition, new regulations in Circular No.133/2016 have removed the LIFO method of calculating inventory value, which helps to accurately reflect market value of inventory at the report date. Investment securities are subsequently separated trading securities from held-to-maturity reflecting correctly the value of the assets of the enterprise. Trading securities will be recognized at market prices while held-to-maturity securities will reflect their original prices. However, some accountants argue that the method for making provisions for contingencies and provisions for bad debts are still quite general and subjective so that they should be able to affects the

reliability of accounting information.

**Relevance:** All study groups agree that Circular No.133/2016 provides accounting information that promptly reflects the fluctuations of emerging economic activities that affect the financial position. New regulations in Circular 133/2016 allow making provision for losses and impairment of investment properties, which is not mentioned in Decision 48/2009. Moreover, the principle of recording revenues and expenses by the nature of economic transactions, not base on transactions have shown the truthfulness of business results and predictive power for the accounting information users.

However, according to the opinion of the lecturers teaching accounting at universities, the Circular 133/2016 still have some limitations when the regulations have not allowed SMEs to revalue assets at market prices. For example, in the case of trading securities, SMEs are only allowed for making provision when the price of securities decreases but SMEs are not allowed to record value of trading securities to market value when the price increases. This is not in line with international accounting practices and US GAAP. In addition, the new Accounting system does not require SMEs to disclose specific information on types of non-current assets that are not in use, or planned to be disposal, or available for sale. In addition, the removal of information on off-balance sheet account in new accounting systems for SMEs will limit access of users with accounting information.

**Understandability:** All three study groups agreed that Circular No.133/2016 makes accounting information more understandable when issuing regulations for SMEs to present detailed information regarding the amounts Payables, details of receivables, payables, details of the assets of the enterprise base on the purpose of holding assets.

## 5.2. Suggestions and implications

### Suggestions related to accounts

According to the recommendations of the lecturers, Circular No.133/2016 should keep tracking the off-balance sheet account to provide information of the fixed assets of the outsourced enterprises or consignment.

At the request of the auditors, the accounting system should promulgate regulations allowing the accounting the value of gold, silver, gemstones used for payment purposes in the item "Cash and cash equivalent" on the financial statement.

### Suggestions related to asset valuation

Circular 133/2016 has made a strong move, approaching more closely to International Accounting Standards and US Accounting Standards when classifying financial investments in SMEs into "trading securities" and "Investments held to maturity date". However, the value of "Trading securities" recorded in the financial statements cannot be higher than the original price (cost). This means that, when the stock price falls below the original price, the SMEs make provisions. As the stock price rises, SMEs are not allowed to record at market prices. This makes the asset value of the business presentation is not honest and reasonable. As opinion of lecturers, nowadays, Vietnam has had a stock market in operation for more than 15 years with transaction data reflected objectively and under the control of the State Securities Commission, information on stock prices was very transparent and reliable for SME use. Therefore, both groups of respondents (Group 2 and Group 3) recommended the Ministry of Finance should soon issue regulations allowing enterprises to recognize the gain from the increase in the value of trading securities.

### Suggestions for presentation of accounting information

For those non-current assets of SMEs which operated ineffectively and SMEs have plans to liquidate, SMEs need to present full information about those non-current assets on both the balance sheet and the statement of income. On the balance sheet, non-current assets that are no longer used, awaiting liquidation, are presented at fair value and presented in a separate section, independent from those fixed assets in service of normal operation. Those assets are not depreciated. In the Income Statement, the SMEs should present the business results of the year generated by the production line and the results of liquidation those assets classified under the title "Non-current assets available for sale". Presenting detailed information regarding "Non-current assets available for sale" makes accounting information more honest and useful for interested parties.

## 6. Conclusion

This study collected the assessments of state management experts, auditors and accounting professors at universities about the characteristics of accounting information after the Ministry of Finance issued Circular 133 / TT-BTC. Research results show that new SMEs accounting system issued in accordance with Circular No.133/2016/TT-BTC is closer to conventional practices and international accounting standards. Accounting information provided by SMEs is more complete and accurate, making it easier for users to make economic decisions. However, accounting experts have given some suggestion to the Ministry of Finance, in order to improve the accounting quality, the Ministry of Finance should consider some important contents such as valuation of trading securities and presentation of information on those non-current assets available for sale to make accounting information more faithful.

## References

- [1] Do Anh Tuan (2016), "The Role and Position of Small and Medium Enterprises in Integration," <http://www.baomoi.com/vai-tro-vi-tri-cua-doanh-nghiep-Kashmir-hoi-nhap / c / 19006647.epi>, accessed 30/03/2016.
- [2] Ministry of Finance (2016), Circular 133/2016/TT-BTC "SME Accounting Regulations" issued on 26 August, 2016.
- [3] Ministry of Finance (2006), Decision 48/2006/TT-BTC "SME Accounting Regulations" issued on 14 September, 2016
- [4] Obaidat,Ahmad N. "Accounting information qualitative characteristics gap: Evidence from Jordan." *International Management Review* 3.2 (2007): 26.

# Factors Affecting People's Intention to Use Urban Railways in Hanoi

Nguyen Thi Le Thuy\*, Bui Thi Hong Viet, Nguyen Duc Huy

National Economics University, Hanoi, Vietnam

## ABSTRACT

This study is based on a combination of the Theory of Planned Behavior (TPB) and TAM (Technology Acceptance Model) theory to analyze factors affecting the intention of using urban railways. In this study, the reliability analysis, exploratory factor analysis, correlation analysis and linear regression analysis are conducted to estimate and test factors impacting people's intention to use urban railways in Hanoi. The results show that there are five factors influencing the intention of using urban railways, including: perceived usefulness of the urban railways; subjective norms; environment awareness; the attraction of alternative products; and perceived behavioral control. In particular, the perceived usefulness of the urban railways has the most significant positive impact on the intention to use urban railways. Based on the results of analyzing and testing survey data, the paper provides appropriate recommendations to promote people's intention of using urban railways in Hanoi

**Keywords:** urban railways, intention, means of individual transport, public transport

## 1. Introduction

In recent years, the number of means of individual transport in Hanoi has been experiencing a dramatic rise. By August of 2015, those statistics reached a peak at 4.9 million motorbikes and 0.54 million cars. Consequently, the average means of individual transport per person was 0.71 in 2015. This dramatic upsurge in the context of inadequate transport infrastructure causing serious traffic congestion in Hanoi. Therefore, urban railways are considered a solution to reduce the pressure on traffic in the city.

Currently, the first urban railway in the Hanoi Urban Railways System is about to be activated. Besides the problems associated with mobilizing resources for the urban railway project, another key concern is to attract people to use this service, especially, encourage them to be regular participators. Positive results in improving people's intention towards urban railways would result in implementing the project faster and significantly contribute to solve the traffic jam in Hanoi.

There are numbers of both theoretical and empirical studies in intention-behavior relations, but a few studies related to evaluating factors influencing people's intention towards urban railways in Hanoi. Thus, this study focuses on clarifying people's intention as well as factors affecting the intention of using the urban railways in Hanoi, then giving some recommendations to encourage people's intention of using this system.

## 2. Literature review

### 2.1. The intention of using products and services

There are different approaches to intention-behavior and factors impacting intention of using products or services. According to Fishbein & Ajzen (1975), intention is a special case of behavioral intention. This approach was summarized by Nisson, C. & Earl, A. (2015), these scholars defined behavioral intention as the perception of being able to perform the targeted behavior. Therefore, the intention of using products and services in this paper is considered the

\* Corresponding author. Tel.: +84989139749  
E-mail address: thuykhoahocquanly@yahoo.com

perception of consumers' ability to use products and services.

In general, behavioral intention and factors influencing behavioral intentions derived from Fishbein & Ajzen's view could be divided into the following main approaches: (1) behavioral intention based on TRA (Theory of Reasoned Action) and TPB (Theory of Planned Behavior); (2) behavioral intention to use IT products based on TPR (Theory of Perceived Risk); and (3) intention to use new technology based on TAM (Technology Acceptance Model).

Based on Fishbein & Ajzen's approach, motivational factors such as attitude and subjective norms significantly affect the individual's behavioral intention of using services. Moreover, some noticeable factors are also indicated from other approaches such as "perceived risk associated with products or services", "perceived risk associated to online trading" (second approach), "perceived usefulness" and "perceived ease of use" (third approach).

## **2.2. Urban railways and factors affecting the intentions of using urban railways**

The concept of urban railways in Vietnam is synonymous with the concept of the metro, which is a huge urban transport system operating on rails and usually has a path for pedestrians under the ground. The urban railway system in Hanoi is a public transport system with completely new technology and several routes activated, but the whole system has not been formally in operation yet.

The people's intention of using urban railways in Hanoi and intention of using a new technology has some affecting factors in common. Thus, this study is based on the combination of TPB and TAM (after eliminating inadequate mediating elements) and adds some practical elements (which are found in the qualitative research) being able to influence people's intention of using urban railways in Hanoi.

## **2.3. Factors affecting the intentions of using urban railways**

### **Perceived usefulness of the urban railways**

This factor is drawn from the TAM model. Perceived usefulness of the urban railways is expected to have a positive impact on the intention of using urban railways. The usefulness of urban railways is the same as those of public transport, including: low cost since the big transportation volume and no need for parking, safety, reduction of traffic jams and accidents... Furthermore, urban railways are quite suitable for big city since this system provides surpassing benefits such as: carrying a large transportation volume, being faster, and ensuring punctuality.

### **The attraction of alternative products**

This factor is out of combined model between TPB and TAM, which represents major barriers to the intention of using urban railways. These barriers are the attraction of alternative means of transport such as public transport or means of individual transports like taxis, bicycles, and motorcycles, ect. However, after activating the urban railways, the means of public transport would become component parts of a unified public transport system whereby some of them as regular buses and BRT (bus rapid transit) connect with urban railways system, so other means of public transport are less competitive with urban railway system. Therefore, the most important barrier to the intention of using urban railways is the attraction of individual transport means. Research by Dang Thi Ngoc Dung (2012) also indicates that the attraction of individual transport means has negative impact on the intention to use urban railways.

### **Subjective norms**

Subjective norms, the so-called stakeholders' influence, are the key element in the TPB model. The influence of stakeholders is considered to be affected from people around such as parents, friends, co-workers, agencies, schools, governments towards the intention of using the urban railway system.

### **Environment awareness**

This factor is similar to the attraction of individual transport means since it is out of TPB and TAM models. However, some studies showed that people's perception of the detrimental effects of individual transport means could enhance their intention of using public transport. Heath & Giford (2002) show that the better awareness of the environment and the problems caused by cars, the less of using cars. This element is also specified in Dang Thi Ngoc Dung (2012) research. Hence, this paper considers the perceived environment as a factor in research model.

### **Perceived behavioral control**

Perceived behavioral control is a factor in the TPB model, it is measured by individual subjective perception of using urban railways, including the ease of use and self-decision making ability. In some empirical studies, this factor has an unclear effect or is identified with other factors. However, this is also one of the basic elements of individual situations that could not or have little control over their behavior towards the intention of using urban railways. Thus, Perceived behavioral control is also analyzed in this study.

### **Demographic factors**

Elements such as gender, age, income, individual means of transport ownership, working location, etc., in a number of related studies are argued to influence the choice of transport means. Therefore, this research incorporates some demographic factors as adjustment variables to test the differences of distinguishable groups in having intention to use urban railways.

### 3. Research model and sample/ Methods

#### 3.1. Research model and scales

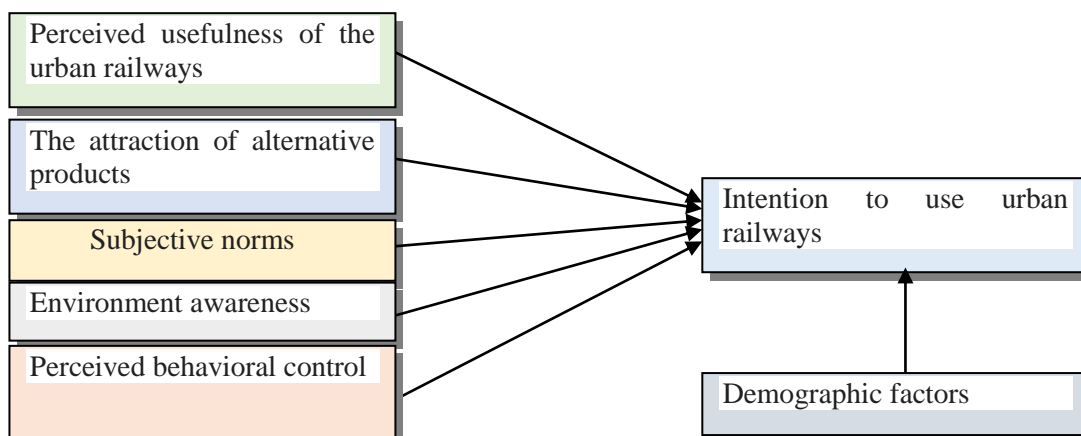

**Fig 1. Research model of factors affecting the intention to use urban railways**

(Source: Dang Thi Ngoc Dung, 2012)

**Table 1. Description of scale**

Code	Description	Source
<b>PU</b>	<b>Perceived usefulness of the urban railways</b>	
PU1	I suppose that using urban railways is convenient	Dang.TND (Dang Thi Ngoc Dung),2012 adjusted from Chen,C.F & Chao,W.H.,2010
PU2	I suppose that using urban railways is safe	
PU3	I suppose that using urban railways is comfortable	
PU4	I suppose that using urban railways is punctual	
PU5	I suppose that the cost of using urban railways is acceptable	
<b>AA</b>	<b>The attraction of alternative products</b>	
AA1	I suppose that using means of individual transport is more convenient than using urban railways	Dang.TND.,2012; Beirao & Cabral., 2007
AA2	I suppose that I could go anywhere in the city with means of individual transport	
AA3	I suppose that means of individual transport is faster than urban railways	
AA4	I suppose that means of individual transport helps me to self-control in time	
AA5	I suppose that using means of individual transport is cheaper than using urban railways	Dang.TND.,2012; Balcombe,R&Mackett,R 2004
AA6	I am used to using means of individual transport	Dang.TND.,2012; Chen,C.F&Chao,W.H.,2010
<b>SN</b>	<b>Subjective norms</b>	
SN1	My family advises me to use urban railways	Dang.TND.,2012; Huang.CH&Hsu.W.C 2015
SN2	My friends advise me to use urban railways	
SN3	My office/school advises me to use urban railways	
SN4	The government advises me to use urban railways	
<b>EA</b>	<b>Environment awareness</b>	
EA1	Using means of individual transport increases environmental pollution	Dang.TND.,2012; Health,Y and Gifford,R ,2002
EA2	Using means of individual transport causes traffic jams in Hanoi	
EA3	Using means of individual transport rises traffic accidents	
EA4	The government encourages me to use urban railways/ public transport to protect the environment	

<b>PBC</b>	<b>Perceived behavioral control</b>	
PBC1	I suppose that urban railways system is easy to use	Huang.CH&Hsu.W.C 2015
PBC2	Decision of using urban railways system depends on myself	
PBC3	I intend to use urban railways when I have enough budget	
PBC4	I intend to use urban railways when I have enough time	
<b>IT</b>	<b>Intention to use urban railways</b>	
IT1	I intend to use urban railways	Huang.CH&Hsu.W.C, 2015
IT2	I plan to use urban railways	
IT3	I will try to use urban railways	
IT4	I will use urban railways regularly	Chen, C.F & Chao,W.H, 2010
IT5	I will advise people to use urban railways	Authors' proposal

(Source: Authors)

### 3.2. Research sample

Research sample was randomly collected in some of the districts within Hanoi where urban railways are being installed, including Cau Giay District, Dong Da District, and Ha Dong District. Sample size is 281 people. Primary data are gathered by two methods:

- Method 1: Online survey. The questionnaire was designed based on google form and sent via email, Facebook to subjects. This method received 170 valid responses.
- Method 2: Direct survey. The authors have issued 120 questionnaires and received 120 responses, reaching 100 percent. The number of valid responses is 111 equivalent to 92.5 percent.

According to Tabachnick and Fidell (2006), for regression analysis, the sample size has to reach at least  $N > 8m + 50$  ( $m$  is the number of independent variables in the model). In terms of factor analysis, Hair et al. (2010) argued that the number of observations needs to be at least five times of the observed variables. The study included five independent variables and 23 observed variables, thus the sample size meet the analysis requirements.

Some initial descriptive statistics show a variety of survey subjects by gender, age, and occupation. Hence, the authors could conduct comparative analysis about intention to use urban railway system among these groups.

## 4. Results and discussion

### 4.1. Reliability analysis of Cronbach's Alpha

This step is to test the intrinsic consistency of the scale built from theoretical model through analyzing Cronbach's Alpha. The results of reliability analysis indicate that the observations PU5 and PBC3 have no intrinsic consistency with other observed variables in the same group and should be excluded from the model. Cronbach's Alpha value of factors in the model is higher than 0.65 after removing both PU5 and PBC3 observations. So, this value is acceptable in this study. The analysis also explores a certain consistency between the primary data collected by observed variables and the factors in the model.

### 4.2. Exploratory Factor Analysis

The EFA analysis results in a shortening of a set of observed variables into meaningful elements from data collected in the survey. This reduction is based on the linear relationship between factors and observed variables. Hair & Associates (2010) point out that EFA is based on a number of conditions to ensure practical meaning such as: (1) the minimum of "factor loading" must be higher than 0.3; higher than 0.4 is considered "important"; higher than 0.5 is considered "practical significance" and is a condition for EFA analysis; (2) the KMO (Kaiser-Mayer-Olkin) has to meet the requirement of  $0.5 \leq KMO \leq 1$ ; (3) Barlett test is statistical significance (or Sig.  $< 0.05$ ); (4) the total variance explains more than 50% of the variation of the observed variables (Total Variance Explained  $> 50\%$ ).

The first EFA analysis shows that two observations PU5 and PBC3 are inappropriate since their factor loading is less than 0.5, hence these factors are little practical significance. They are also considered to be removed from the scale in the step of analyzing the reliability of the scale. Therefore, PU5 and PBC3 are eliminated from the research model.

The results of the EFA analysis with the other observations indicate that there are five independent and one dependent factors that are correlated with the proposed research model. It is a relevant consistency of the proposed research model with practical survey.



**Table 2. Rotated component matrix**

	Component				
	1	2	3	4	5
PU1				,712	
PU2				,721	
PU3				,751	
PU4				,746	
AA1	,651				
AA2	,745				
AA3	,708				
AA4	,668				
AA5	,610				
AA6	,632				
SN1			,775		
SN2			,694		
SN3			,751		
SN4			,768		
EA1		,761			
EA2		,777			
EA3		,760			
EA4		,762			
PBC1					,800
PBC2					,707
PBC4					,809

Extraction method: Principal Component Analysis.

Rotation method: Varimax with Kaiser Normalization.

Rotation converged in 5 iterations

(Source: Authors)

### 4.3. Correlation Analysis

Correlation analysis is used to test linear relationship among variables. Linear regression analysis is implemented on the basis of the linear correlation between independent and dependent variables. The results clarify that independent variables in the research model have a linear correlation with the dependent variable – people’s intention of using the urban railway system. In addition, it is also indicated that there is a linear correlation between two pairs of independent variables, including (AA & PBC) and (AA & SN) (the result of Pearson test is statistical significance). This shows that in the investigated sample, the “attraction of alternative products” factor has a certain relationship with the "subjective norms" and the "perceived behavioral control" factors. It might cause a multiple collinearity in the regression analysis.

### 4.4. Regression Analysis

Based on the literature review of the factors influencing the intention of using urban railways and, through primarily qualitative surveys, the authors propose a model of factors that influence the intention to use urban railways are as follows:

$$IT = \beta_0 + \beta_1.PU - \beta_2.AA + \beta_3.SN + \beta_4.EA + \beta_5.PBC$$

The model consists of five independent variables measured by 23 observation variables and one dependent variable measured by five observation variables. The observation variables use the Likert scale from 1 to 5 with: 1-strongly disagree and 5-strongly agree with the given statements. The specific content of the observed variables is described in Table 1 (Refer to Table 1).

Correlation analysis indicates that regression analysis of the research model is appropriate. Regression method commonly used in similar cases is the multiple regression by Enter method. By using SPSS 20.0 software, the results of linear regression analysis are summarized in the table below (Refer to Table 3):

**Table 3. Mode summary**

Model	R	R <sup>2</sup>	Adjusted R square	Std error of the estimate	Durbin-Watson
1	,720 <sup>a</sup>	,519	,510	,67517	2,088

a. Predictors: (Constant), PBC, SN, PU, EA, AA

b. Dependent variable: IT

(Source: Authors)

The results of the regression model given are appropriate to the adjusted R square of 0.51. This proves that the model could explain 51 percent of the overall correlation between factors impacting the intention to use urban railway system. The value of the adjusted R square is greater than 0.5 approving the reliability of the linear regression model.

**Table 4. Regression results by Enter method**

Model	Unstandardized coefficients		Standardized coefficients	t	Sig.	Correlations			Collinearity Statistics	
	B	Std. Error	Beta			Zero order	Partial	Part	Tolerance	VIF
(Constant)	1,570	,347		4,525	000					
PU	,396	,035	,473	11,244	000	,452	,561	,470	,989	1,011
AA	-,181	,035	-,222	-5,141	000	-,284	-,296	-,215	,939	1,065
SN	,265	,033	,339	8,032	000	,359	,436	,336	,983	1,018
EA	,247	,034	,305	7,219	000	,289	,399	,302	,979	1,021
PBC	,159	,033	,201	4,736	000	,161	,275	,198	,967	1,034

a. Predictors: (Constant), PBC, SN, PU, EA, AA

b. Dependent variable: IT

(Source: Authors)

The results of linear regression analysis show that the VIF (variance inflation factor) of independent variables is less than 10, so there is no sign of multicollinearity. The result of regression analysis is as follows:

$$IT = 1,57 + 0,473.PU - 0,222.AA + 0,339.SN + 0,305.EA + 0,201.PBC$$

The regression results prove that all of independent factors in the model have impacted on people's intention of using urban railways with different levels and different dimensions.

The "perceived usefulness of the urban railways" (PU) factor has the greatest impact on the intention to use urban railways (partial correlation coefficient is 0.561). This is also the very first important factor mentioned in the combined model of TPB and TAM. Thereby, people tend to more concern about convenience, safety, comfortability and punctuality before deciding to use urban railway system. This result is consistent with the fact that traffic jams in Hanoi are causing a number of problems for the people. So, they will use urban railways when the benefits above are guaranteed.

The "attraction of alternative products" (AA) factor has a negative impact on the intention to use urban railway system. In terms of influence level, this factor is ranked 4<sup>th</sup> (partial correlation coefficient is -0.286), but not too low compared to other factors. And it is also the only factor in the model having the opposite effect to people's intention of using urban railways. In fact, the attraction of alternative products is considered a big barrier to the intention of using public transport in Hanoi. For many people, they prefer to use means of individual transport rather than public transport as travelling by individual transport means is faster, more convenient and flexible.

The "subjective norms" (SN) factor is the second one after PU having impact on intention to use urban railways (partial correlation coefficient is 0.436). Those groups such as relatives, parents, friends, co-workers and their suggestions have significant influence on intention of using urban railways even if those routes are inactivated yet.

The "environment awareness" (EA) factor is ranked 3<sup>rd</sup> (with partial correlation coefficient (0.302)). For residents, the awareness of negative effects caused by individual transport means makes them not only pay more attention to protect the environment but also actively use other replaced means of transports. Therefore, the "environmental awareness" factor has positive impact on the intention to use urban railways system in Hanoi.

The "perceived behavioral control" (PBC) factor has the lowest impact on the dependent variable. This factor describes situations where people are unable or less able to control their intention of using urban railways. Although the urban railway system has not been officially operated, when it comes to operate there might be some issues out of people's control as the ease of use, the restriction in decision making being an obstacle to the intention of using urban railway system. Hence, perceived behavioral control is also a positive factor in raising awareness of using urban railway system.

#### 4.5. Difference means of test

By testing qualitative variables such as gender, age, occupation, marital status and income, the research has not affirmed that these variables causing distinguish-ability among different groups towards the intention of using urban railway system.

#### 5. Conclusion and recommendations

Research results indicate that people's intention to use urban railways in Hanoi is driven by five groups of factors. These factors are ranked from the strongest to the weakest influence as the following order: perceived usefulness of urban railways; subjective norms; environment awareness; the attraction of alternative products; perceived behavioral control.

In addition, the research results also provide some recommendations to the Management Authority for Urban Railways and State management agencies to raise people's intention of using urban railways in Hanoi.

Firstly, for the factors of "perceived usefulness of urban railways", the Management Authority for Urban Railways and others management agencies are recommended: to have a plan for installation and operate the urban railway system properly and exactly; to announce the schedule on the mass media; to print and provide the schedule at crowded residential areas, railway stations and on the trains. Furthermore, with some routes that are going to be activated, the Management Authority for Urban Railways is required to guarantee that all the stations and trains are clean, safe and punctual. Other management agencies are suggested to quickly assess and set-up reasonable decisions about costs and fares when the first route is activated. Besides, these agencies should provide an incentive policy of fare to improve "perceived usefulness of urban railways" and encourage people to use urban railway system.

Second, for the factors of "subjective norms", communication strategies which exhort people to use and propagandize urban railway system to their families and friends should be developed.

Third, for the factors of "environment awareness", competent authorities should promulgate campaigns to raise people's awareness about the environment and the positive impact of the urban railways to the environment such as reducing traffic jams.

Fourth, for the factors of "the attraction of alternative products", besides solutions to develop the urban railway system in order to improve the capacity of public transport within the city, the state competent authorities are suggested providing reasonable restrictions of individual transport means. These solutions might have negative impact on the psychology of residents, therefore, these restrictions should be implemented only when the capacity of the public transport system, especially the urban railway system meets the needs.

Fifth, for the factors of "perceived behavioral control" which are the least important, but highly strong factors influencing the intention of using urban railway system, it is suggested that people should understand more about this system and be proactively grasp problems occurred the first time using it so that they could accept the urban railways throughout their own experience.

#### References

- [1] Balcome, R.;Mackett, R., et al. (2004), The demand for public transport: a practical guide, TRL Report, London.
- [2] Beirao, Gabriela, Cabral, J. (2007). Understanding attitudes towards public transport and private car: A qualitative study. *Transport Policy*, 14 (6), 478-489.
- [3] Chen, C. F. & Chao.W.H (2010), Habitual or Reasoned? Using the Theory of Planned Behavior, Technology Acceptance Model, and Habit to Examine Switching Intention Toward Public Transit, *Transportation Research, Part F*.
- [4] Chih-Hsuan Huang & Wei-Che Hsu (2015), The extension of the Theory of Planned Behavior to Predict the Use of Public Transport, *Asian Journal of Business and Management*, 3 (5).
- [5] Dang Thi Ngoc Dung (2012), Factors affecting the intention to use Metro system in Ho Chi Minh city, University of Economics Ho Chi Minh City.
- [6] Fishbein, M., & Ajzen, I. (1975). *Belief, Attitude, Intention, and Behavior: An Introduction to Theory and Research*. Reading, MA.
- [7] Hair, J. F., Black, W. C., Babin, B. J., Anderson, R. E.,& Tatham, R. L. (2010). *Multivariate data analysis* (7th ed). Pearson Prentice Hall.
- [8] Heath, Y. & Gifford, R. (2002), Extending the Theory of Planned Behavior: Predicting the Use of Public Transport, *Journal of Applied Social Psychology*, 32, 2154-2189.
- [9] Nisson, C. & Earl, A. (2015), *The Theories of Reasoned Action and Planned Behavior: Examining the Reasoned Action Approach to Prediction and Change of Health Behaviors*, University of Michigan.
- [10] Tabachnick, B. G., and L. S. Fidell. (2006). *Using multivariate statistics* (5th ed). Pearson, New York, USA.

# Valuing Economic Impact of Climate Change on Catch Fisheries in Vietnam

Nguyen Thi Vinh Ha\*

University of Economics and Business, Vietnam National University, Hanoi, Vietnam

## ABSTRACT

Fisheries is among the first industries to be affected by climate change. Yet studies on economic impacts of climate change on fisheries in Vietnam are still limited. By using production function and partial equilibrium analysis, changes in social economic surplus of catch fisheries sector due to climate change are estimated. The results show that catch fisheries production in Vietnam is negatively affected by climate change. Rise in temperature is the major cause of decrease in catch yield. The social loss in 2025 and 2055 are 29.9 and 32.7 trillion dongs respectively at 2014 price according to RCP4.5 scenario. At RCP8.5 scenario, the social loss is larger, 39.7 and 46.7 trillion VND in 2025 and 2055 respectively. In most cases, consumers suffer significantly from the reduction in catch yield, while producers are less affected. Fishers sometimes even benefit from impact of climate change as fisheries price tends to go up. These findings suggest that fishers could reduce their capture effort to gain from higher fisheries price, while aquaculture production should be expanded to fill the gap of catch fisheries supply and demand.

**Keywords:** catch fisheries; climate change; valuation of economic impact; Vietnam

## 1. Introduction

The world is facing with several environmental problems such as climate change, pollution, biodiversity loss, water resource degradation, and desertification, etc. These issues are interacted and have impacts on people and societies. Among those, “the climate crisis is the greatest challenge humanity has ever faced” (Al Gore, Peace Nobel Prize winner 2007). Scientists prove that climate change is a big threat to human being and global natural system, requiring countries to act together for mitigation and adaptation [15].

Fisheries is among the first industries to be affected by climate change [31], via several direct and indirect impacts of physical, biological and chemical factors, including temperature, wind, salinity, oxygen concentration, potential of hydrogen (pH) and others [26]. Climate change directly affects growth, reproduction, behaviour, and distribution of fishes [4]. Indirect impacts of climate change via ecosystem processes influence food abundance, competitors, predators and pathogens [4]. Climate change leads to loss of fisheries revenues and profits of entrepreneurs and households in many areas, especially in countries with warm sea, while it sometimes benefits other countries such as those with cold water [25]. However, fisheries in both regions might get damages due to water quality degradation and spread of diseases [31].

There are several studies valuing impacts climate change on fisheries in the world. The study of the Economic Commission for Latin America and the Caribbean [12] employs production function to describe the inverse relationship between fisheries yield (capture and aquaculture) with fisheries export price, sea surface temperature and precipitation in Guyana. Loss of fisheries sector under A2 scenario in 2050 is from 15 million USD (at discount rate 4% per year) to 34 million USD (discount 1%); under B2 scenario, the estimated loss in 2050 is from 12 to 20 million USD. Caviedes and Fik [6] use time series model and find that in El Nino event in 1997-1998, catch yield of small pelagic fish of Peru and Chile drops by 50% and 52% respectively, leading to a decline of fisheries export at 8.2 billion USD. This sharp cut causes negative economic influence in both countries, including loss of jobs and incomes. Narita et al. [18] perform a partial-equilibrium analysis and estimate that the global economic costs of mollusk due to ocean acidification could be over 100 billion USD with an assumption of increasing demand of mollusks at expected income growths and a

\* Tel.: +84 985545569.  
E-mail address: ntvha@vnu.edu.vn

business-as-usual emission trend towards the year 2100.

Vietnam locates in tropical region with warm sea. Its fisheries sector is therefore more likely to be adversely affected by climate change. Unfortunately, studies on economic impacts of climate change on fisheries in Vietnam are still limited. There are a few quantitative researches which focus on aquaculture sector. Kam et al. [17] use benefit-cost analysis and predict that shrimp and catfish profits will reduce by 100 million dong and 4 billion dong per hectare respectively as compared to non-climate change scenario. Pham Quang Ha et al. [24] find out that there is no relationship between shrimp yield and temperature and precipitation in Phu Tho and Hoa Binh provinces. Cao Le Quyen et al. [5] employ Cobb-Douglas production function to value impacts of temperature and precipitation under climate change scenarios on shrimp aquaculture in Thanh Hoa and Ha Tinh provinces. Their results indicate an adverse relation between shrimp yield and temperature and precipitation. Nguyen Ngoc Thanh et al. [21] apply production function to estimate impacts of climate change on catch and aquaculture fisheries in northern provinces. Their findings show that loss of catch fisheries sector is 584 billion VND in 2050 (at discount rate 3%). However, their research only evaluates loss in terms of revenue, without mentioning losses of consumer surplus and fisher’s profit.

Mitigation and adaptation with climate change requires enduring and costly efforts of all people in many generations. Valuing economic impact of climate change on Vietnamese fisheries are therefore necessary to provide policy decision makers with suitable solutions.

This study aims at quantifying economic losses (or gains, if it is the case) of consumers, producers (i.e. fishers) and the entire society due to climate change in the catch fisheries market in Vietnam.

## 2. Methodology

### 2.1. Methodological framework

According to Sumaila et al. [26], impacts of climate change on fisheries include changes in productivity of fish stocks, shifts in fish-stock distribution, changes in ecosystem productivity, impacts on fishing costs, prices, ex-vessel revenues, resource rents and benefits. This study applies the methodological framework adjusted from Sumaila’s study as illustrated in Figure 1.

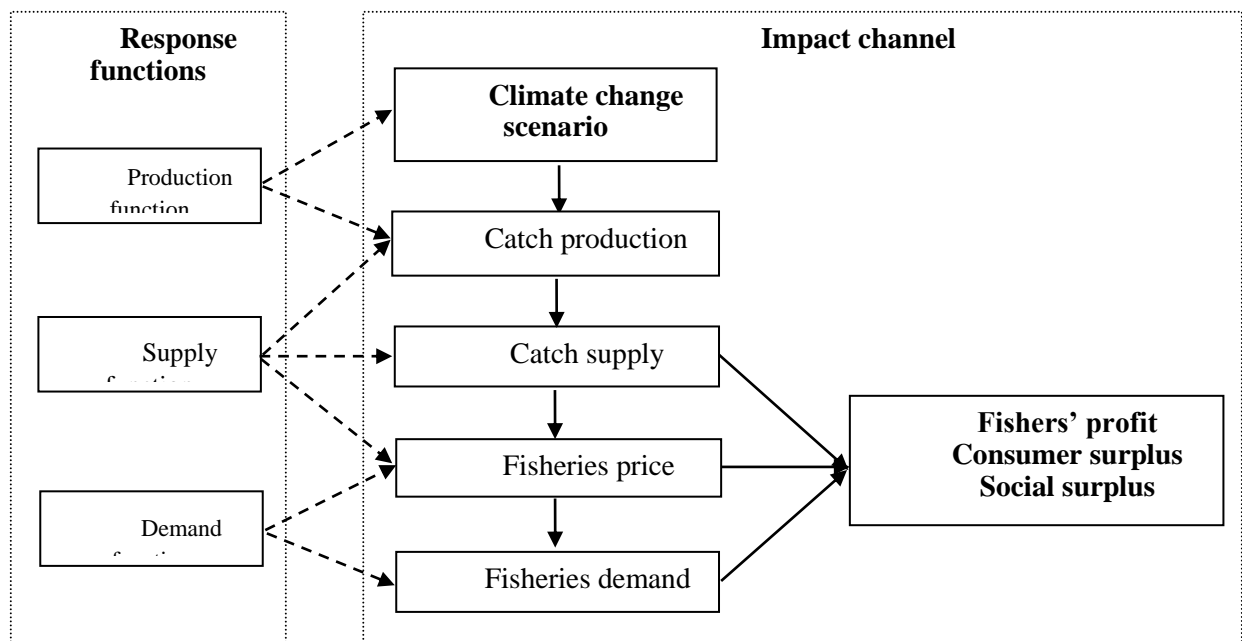

**Figure 1: Methodological framework**

Source: Adjusted from Sumaila et al. [26]

The economic impacts of climate change on catch fisheries in Vietnam can be described as follows:

Impact on catch production and supply curve: Due to climate change, fish stocks will decline because of reduction in reproduction, decrease in size of mature fish, migration, diseases, deaths, food competitions, and predators, etc. In addition, fishing costs will increase due to incremental investment in fishing vessels and gears to adapt with changes in fish stocks, species composition, and distribution. Changes in migration behaviour and fish-stock distribution may lengthen travel time of fishing boats, then escalating fuel and ice consumption. Decrease in fish-stocks and increase in fishing costs will reduce catch production and shift the catch supply curve to the left side.

Impact on prices and demand quantity: As supply lowers, price will go up and demand quantity will go down, if other factors remain unchanged.

Impact on profit (producer surplus), consumer and social surpluses: Profit of fishers will alter because of changes in yield, costs and prices. Since studies on changes in consumer and social surpluses due to increasing fish price in climate change scenarios are not yet available, this research should concern.

This study employs production function to quantify impact on catch fisheries production under different climate change scenarios. Partial equilibrium analysis technique is applied to calculate loss in social surplus, in which price elasticities of supply and demand are identified via corresponding response functions.

## 2.2. Production function method

Production function method is widely used in literatures to evaluate impact of changes in environmental quality (e.g. acid rains or water pollution) on agriculture [1] and fisheries [16]. This method is also applied in analyzing impact of run-offs [2], and in identifying protection value of mangroves against typhoons [14]. According to Barbier [2], the production function method is appropriate in developing countries as their productions much rely on natural resources and ecosystems.

The Cobb-Douglas function is served as a base to develop climate change impact evaluation model. Total fishing capacity is used as a proxy for capital investment. In addition to traditional production inputs such as capital and labour, the model uses climate indices to quantify impact of climate change on catch output. Sea surface temperature (SST) affects migration behaviour of fishes. Marine fishes and other aquatic species are poikilotherms, whose internal temperature varies considerably. They are therefore very sensitive to variation in environmental temperature and tend to migrate to water areas with their preferred temperature [31]. Oxygen concentration and pH alter unfavourably to aquatic species due to rise in temperature [4]. Precipitation affects growth of aquatic species as it changes water environment such as salinity [4]. Heavy rains also prevent fishers from fishing activities [19]. Typhoons with wind speeds of level 8 or more keep fishers away from production and damage vessels (while wind with speed of level 6 and below are satisfactory to fishing activities on sea) [19]. Southern Oscillation including El Nino and La Nina may alter fish flows and affect fishing yield [6]. Therefore, SST, annual rainfall, number of typhoons and Southern Oscillation index are included in the evaluation model.

The production function to evaluate impacts of climate change on fisheries in Vietnam is as follows:

$$\ln(\text{Catch}_t) = \beta_0 + \beta_1 T + \beta_2 \ln(\text{Capacity}_t) + \beta_3 \ln(\text{Labour}_t) + \beta_4 \text{SST}_t + \beta_5 \ln(\text{Rainfall}_t) + \beta_6 \text{Typhoon}_t + \beta_7 \text{SOI}_t + \varepsilon_t \quad (1)$$

Variable descriptions and sources of data are described in Table 1.

**Table 1: Variable description and sources**

Variable	Description	Sources
Catch <sub>t</sub>	Fisheries capture yield in year t (tons)	Vietnam Institute of Fisheries Economics and Planning [19] and General Statistical Office
Capacity <sub>t</sub>	Total capacities of fishing vessels in year t (CV)	Vietnam Institute of Fisheries Economics and Planning [19] and General Statistical Office
Labour <sub>t</sub>	Number of fishers in year t (persons)	Vietnam Institute of Fisheries Economics and Planning [19]; missing data in 1978 and 2011 – 2014 are filled by forecasting function in MS Excel.
SST <sub>t</sub>	Average sea surface temperature in year t (°C)	The National Oceanic and Atmospheric Administration (NOAA, USA)
Rainfall <sub>t</sub>	Total precipitation in year t (mm)	Climate Change Knowledge Portal, World Bank
SOI	Southern Oscillation index. SOI is the difference in sea-level atmospheric pressures between Tahiti and Darwin. SOI is negative when El Nino occurs and positive when La Nina occurs [20].	NOAA, USA
Typhoon <sub>t</sub>	Number of typhoons on the East Sea in year t	Center for Hydrometeorology Forecast Central Dinh Van Uu [11]
t	Time trend, often reflects improvement in technology and production experience.	From 1976 to 2014 (39 observations)
β <sub>i</sub>	Coefficients	
ε <sub>t</sub>	White noise	

For this time series function, autoregressive-distributed lag (ARDL) model is applied to capture the lag impact of previous year(s) on fisheries output. ARDL is also appropriate for regression model with small number of observations (n ≤ 30) [22]. Long-run form derived from ARDL regression is used to identify the long run impact of climate change

on yield.

### 2.3. Partial equilibrium analysis method

Partial-equilibrium analysis method is applied to evaluate changes in producer, consumer and social surpluses. The supply curve is expected to rotate leftward under climate change impact. The demand curve might rotate rightward in the future because of expanding population and changes in consumer’s preferences. However, much of the rising demand will be borne by growing aquaculture sector. To simplify the analysis, we assume that there is no change in the demand curve and the supply curve will shift leftward due to adversely impact of climate change. In

Figure 2, loss of consumer surplus is the area of A + B; loss of producer surplus is the area of C – A, and loss of social surplus is the total losses of consumer and producer surpluses, which is the area of B + C.

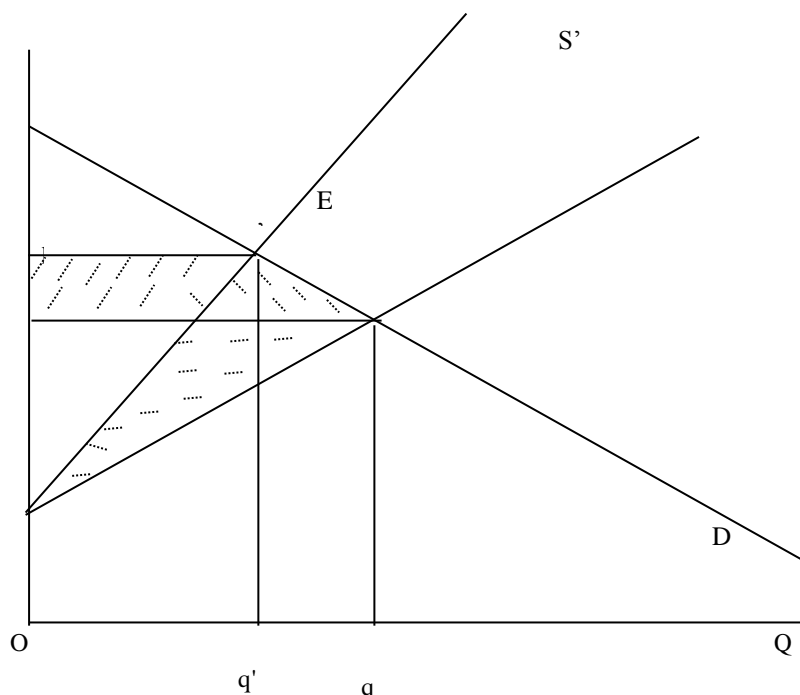

**Figure 2: Losses of consumer, producer and social surpluses**

To calculate the changes in consumer and producer surpluses, we need to identify the price elasticities of supply and demand.

From demand side, a Marshall demand curve is developed at household level. Demand depends on fisheries price, income, prices of substitutions and other independent factors [7]. The demand function has the form of  $Q = a + bP$ , in which  $Q$  is consumption quantity,  $P$  denotes price,  $a$  and  $b$  are coefficients and  $b$  is negative to reflect that demand decreases when price goes up and vice versa. In addition, household fisheries demand depends on income per capita, household size and others. Cheng and Capps [7] states that factors affecting fisheries demand include regional location, urban/rural area, occupation, employment, education, age, number of children, race, religion, crop, availability of fisheries shops, income, household size, prices of substitutions (chicken and red meat) and fisheries price.

Data from Vietnam Household Living Standard Survey 2014 are exploited to develop the fisheries demand function in Vietnam. Dependent variable is fisheries consumption quantity in 12 months, irrespective of catch or aquaculture. By theory, fisheries intake depends on its own price. When income per capita rises, consumption increases. Prices of substitutions, which are often pork and chicken in Vietnam, also affect fisheries consumption. An increase in household size leads to an increase in fisheries intake. Besides, geographical variables such as regions and coastal area and characteristics of household head such as gender, age, marital status, and occupation might influence fisheries consumption. The fisheries demand function has the following form:

$$\ln(Q_{fish}) = \beta_0 + \beta_1 \ln(P_{fish}) + \beta_2 \ln(Y) + \beta_3 \ln(P_{pork}) + \beta_4 \ln(P_{chicken}) + \sum_{i=5}^n \beta_i X_i + \varepsilon_t \quad (2)$$

In which

$Q_{fish}$  is household fisheries intake in 12 months (kg);

$P_{fish}$  is fisheries price paid by household (thousand dong per kg);

$Y$  is household income per capita (thousand dong);

$P_{pork}$  and  $P_{chicken}$  are prices of substitutions, including pork and chicken (thousand dong per kg);

$X_i$  are other independent variables, including dummies for 5 geographical regions: Red River Delta, North Central and Coastal Central, Central Highland, South East, and Mekong Delta; North West region is the base category; coastal provinces, number of household members, and characteristics of household head such as gender, age, marital status, and occupation (self-employed in agriculture, self-employed in non-agriculture or service sector; non-self-employment is the base category);

$\beta_k$  are coefficients, in which  $\beta_1$  is the own price elasticity; and  $\varepsilon_t$  is error term.

Ordinary least square regression with robust standard errors is employed to solve the heteroskedasticity of the regression model.

From supply side: According to Delgado [10], supply of fisheries is limited by fish stocks and fishing regulations which do not respond well to price changes, at least in the short run (less than 5 years). Recent worldwide fisheries studies show that there is no elasticity of supply to prices [23]. Copes [8] argues that free access leads to over-exploitation, so fisheries yield will decline despite rising prices, resulting in a backward bending supply curve. In the beginning, a rise in price leads to a rise in supply, then fish-stocks deteriorate due to over-exploitation, consequently, supply falls even price increases. However, according to Pascoe and Mardle [23], in the long run, price elasticity of catch fisheries is still positive. When fish price falls while other conditions remain unchanged, long-term fishing effort decreases and this in general benefits fish stocks.

The International Model for Policy Analysis of Agricultural Commodities and Trade (IMPACT) of the IFPRI (USA) [18] finds that the price elasticity of catch fisheries is between 0.2 and 0.4. The IMPACT model uses a system of price elasticities of fisheries and 22 non-fisheries commodities in 36 regions and countries (including South East Asia) to estimate fisheries supply and demand functions. In this study, we choose the elasticity value at 0.2 since catch production in Vietnam is over the maximum sustainable yield [29]. Hence, when fisheries price goes up by 1%, its supply grows by 0.2%, while other things equal.

### 3. Results

#### 3.1. The catch fisheries production function

Unit root tests show that all variables are integrated of order 0 or 1, which are suitable for ARDL regression [22]. Selection criteria following vector autoregression regression advise that we should choose 3 lags for all dependent and independent variables. Post-regression tests are conducted with favourable results. F-bound test proves that there is long-run relationship among catch yield and other independent variables. Ramsey Reset test indicates model specification is proper. ARCH test and Durbin-Watson d statistics show that heteroskedasticity or multicollinearity does exist in the model. Jarque-Berra test shows a normal distribution of residuals and unit root test implies that the residual series is stationary, confirming white errors. CUSUM test indicates that the coefficients are stable over time, however CUSUMSQ test does not tell this. Breusch-Godfrey test shows that there is autocorrelation in the model and Newey-West regression is applied as a remedy. The Error Correction variable in Error Correction Model derived from ARDL model is significantly negative, indicating that there is long-run convergence of coefficients. In short, all test results show that the ARDL regression model is appropriate and reliable.

**Table 2: Long-run form of production function**

Variable	Coefficient	Standard Error	t-statistics	Probability
LnCapacity	0.1360	0.0754	1.8035	0.1048
LnLabour	0.3564***	0.0587	6.0716	0.0002
SST	-0.2256***	0.0686	-3.2886	0.0094
LnRainfall	-0.5955***	0.1542	-3.8623	0.0038
Typhoon	-0.0050	0.0039	-1.2655	0.2375
SOI	0.0663***	0.0198	3.3402	0.0087
@TREND	0.0163	0.0092	1.7699	0.1105

Dependent variable is LnCatch, n=36 after adjustment, \* p<0.1, \*\* p<0.05, \*\*\*p<0.01

Results in Table 2 show that in the long run, when SST increases by 1 °C, catch yield falls by 22.56%, and if precipitation rises by 1%, the yield drops by 0.60%. Typhoons do not influence fishing yield significantly. In addition, the coefficient of SOI is positive, explaining that yield decreases when El Nino occurs and increases in case of La Nina.

Applying climate change scenarios of Vietnam developed in 2016 [3], the percentages of decrease in catch fisheries supply due to climate change in 2025 and 2055 according to the average emission scenario RCP4.5 and the high emission scenario RCP8.5 are illustrated in Figure 3.



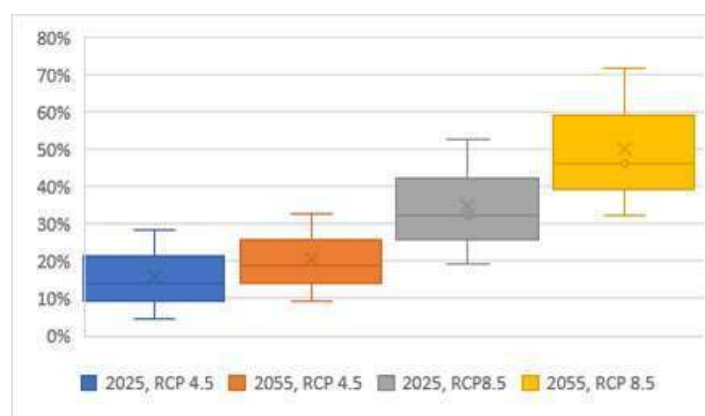

**Figure 3: Percentages of decrease in catch fisheries supply in 2025 and 2055, by different climate change scenarios**

Compared to fishing yield in 2014, the catch supply in 2025 may decrease from 4.6% to 28.3%, with an average of 14.2% in RCP4.5 scenario and from 9.5% to 32.9% (average 18.9%) in RCP8.5 scenario. In 2055, the supply shrinkage is much larger, from 19.4% to 52.6% (average 32.4%) in RCP4.5 and from 32.1% to 71.8% (average 46.2%) in RCP8.5. Rise in temperature is the major cause of decrease. The size of yield decrease depends on the level of rise in temperature and precipitation at each emission scenario.

### 3.2. The fisheries demand function

The results of regression on demand function are depicted in Table 3. Robust Standard Errors is used as a remedy for heteroskedasticity. Variance inflation factor (VIF) test proves that there is no multicollinearity among variables.

**Table 3: Fisheries demand function model in Vietnam, 2014**

Variable	Coefficient	Robust Error	Standard	t-statistics	Probability
LnPfish	-0.2022	***	0.0214	-9.45	0.0000
LnY	0.2349	***	0.0123	19.10	0.0000
LnPpork	0.1514	**	0.0623	2.43	0.0150
LnPchicken	0.0697	**	0.0269	2.59	0.0100
Hhmembers	0.1202	***	0.0053	22.88	0.0000
Redrivedelta	0.3185	***	0.0261	12.20	0.0000
Northcentral	0.5901	***	0.0331	17.81	0.0000
Centralhigh	0.4510	***	0.0315	14.34	0.0000
Southeast	0.5452	***	0.0290	18.78	0.0000
Mekongdelta	0.9338	***	0.0288	32.46	0.0000
Coastal	0.2774	***	0.0211	13.15	0.0000
Gender	-0.0105		0.0216	-0.49	0.6270
Age	0.0011	**	0.0006	1.99	0.0470
Marriage	0.1070	***	0.0260	4.11	0.0000
Agriculture	-0.0785	***	0.0178	-4.42	0.0000
Service	0.0264	*	0.0158	1.67	0.0940
_cons	-0.2538		0.2840	-0.89	0.3710

Dependent variable: LnQfish, n= 8282, Prob(F)=0.0000, R<sup>2</sup>=0.3196

The regression results show that the own price elasticity of fisheries demand is -0.20, i.e. when price goes up by 1%, fisheries demand drops by 0.20%.

### 3.3. Economic impact of climate change on catch fisheries

In 2025, losses of consumer surplus are 41.9 and 55.0 trillion dong at 2014 price in RCP4.5 and RCP8.5 scenarios, respectively. In 2055, consumer losses are more than double, at 90.7 and 124.6 trillion dong by RCP4.5 and

RCP8.5 scenarios accordingly. Producer losses are much smaller, from 1.5 to 2.7 trillion dong in 2025 and from 8.0 to 16.3 trillion dong in 2055, depending on climate change scenarios (Figure 4).

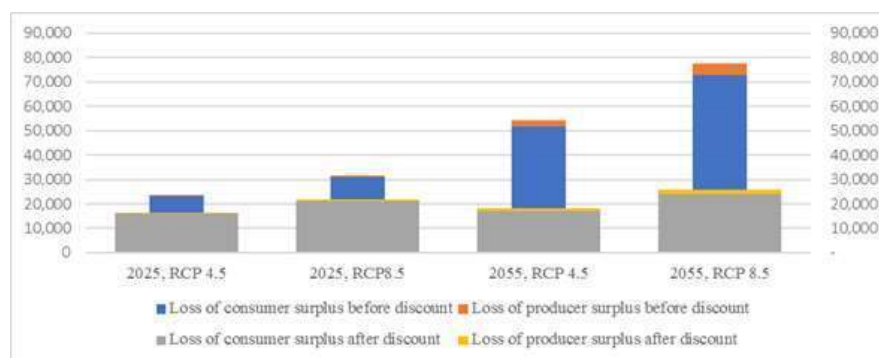

**Figure 4: Losses of social surpluses due to climate, before and after discount of time preference**

Weitzman [30] conducts a survey on 2160 economists on social discount for costs and benefits of policies against climate change and he suggests a gamma distribution of social discount rates at 4% for years 1–5, 3% for years 6–25, 2% for years 26–75, 1% for years 76–300, and 0% for years from 300. Applying Weitzman’s discount rates, we come up with the estimates for losses of social surplus in catch fisheries sector, which are 29.9 and 39.7 trillion dong in 2025 following RCP4.5 and RCP8.5 scenarios respectively; in 2055, the losses are 32.7 and 46.7 trillion dong for the two scenarios.

#### 4. Discussions

The shift of fisheries supply curve to the left pushes price up. Since the price elasticities of supply and demand are low (0.2), a small change in supply leads to a big change in price. Impacts of climate change reduce catch yield from 14.24% to 18.94% in 2025 corresponding to average and high emission scenarios. New equilibrium price upsurges from 35.61% to 47.34% accordingly. Fisheries price even escalates further in 2055, at 80.94% and 115.53% in RCP4.5 and RCP8.5 scenarios respectively. Higher prices bring losses to consumers. For fishers, the loss due to lower supply quantity is largely compensated by benefits from higher selling unit price. Loss of producers is therefore much lower than loss of consumers, which accounts for 4-5% of social loss in 2025 and 8-12% in 2055.

According to DARA [9], the loss of fisheries sector due to climate change in Vietnam, including catch, aquaculture, processing, logistics, etc. is USD PPP 1.5 billion in 2010 and USD PPP 25 billion in 2030 at 2010 price. Catch accounts for 39% of total fisheries production, which includes catch and aquaculture and excludes fisheries processing and logistics [27]. In this study, the social loss of catch fisheries sector in 2025 are from 43.4 to 57.7 trillion dong at 2014 price (no discounts), equivalent to 5.8 to 7.8 billion USD at 2010 PPP price, which are comparable to DARA’s estimates.

The total social loss due to climate change are tremendous as compared to catch revenue in 2014, from 25% to 33% in 2025 and from 27% to 38% in 2055 (after discounts), depending on RCP scenarios, and the consumers suffer most of this loss.

Vietnam’s population is projected to increase and reach peak by 2057 with 113.3 million people and to decrease after that [28]. The demand curve might therefore shift upward. Fisheries price will go further, leading to more loss of consumer surplus. Fishers might gain from this shift since they can get more profit from higher price and less reduction in sale quantity. Assuming an increase of 10% of demand due to a 10% increase in population by 2025 as compared to the year 2014 [28], sensitivity analysis shows that consumers will lose 61.7 trillion dong while fishers gain 27.2 trillion dong and the whole society lose 34.5 trillion dong at 2014 price after discounts.

Aquaculture production is expanding rapidly in Vietnam and worldwide [13]. This trend might affect catch production as it shifts consumer fisheries consumption from catch to aquaculture products. Fish price might not increase in the future, despite of decreasing supply induced by climate change or increasing demand due to bigger population. Sensitivity analysis shows that if the demand curve shifts downward to the point that fish price remains stable, then both consumer and producer suffer equally from loss of catch consumption, and the social loss is about 120 trillion dong.

#### 5. Conclusion

Catch fisheries production in Vietnam is negatively affected by climate change. Rise in temperature is the major cause of the decrease in catch yield. The shift of supply curve to the left pushes fisheries price up, bringing tremendous losses to consumers. For fishers, the loss due to lower supply quantity is largely compensated by benefits from higher selling unit price. Loss of producers is therefore much lower than loss of consumers. The social loss estimates of catch fisheries sector in 2025 and 2055 are 29.9 and 32.7 trillion dong at 2014 price according to RCP4.5 scenario. At

RCP8.5, the social loss is larger, 39.7 and 46.7 trillion dong in 2025 and 2055 respectively.

In most cases, consumers suffer significantly from the reduction in catch fisheries production, while producers are less affected. Fishers sometimes even benefit from impact of climate change as fisheries price tends to go up. These findings suggest that fishers could reduce their effort to gain from higher fisheries price, while aquaculture production should be expanded to fill the gap of catch fisheries supply and demand.

## References

- [1] 1. Adam, R.M., J.M. Callaway, and B.A. McCarl, 1986. Pollution, Agriculture and Social Welfare: The Case of Acid Deposition. *Canadian Journal of Agricultural Economics/Revue canadienne d'agroeconomie*. **34**(1): p. 3-19.
- [2] 2. Barbier, E.B., 1998. Environmental Project Evaluation in Developing Countries: Valuing the Environment as Input, in *World Congress of Environmental and Resource Economists: Venice*.
- [3] 3. Bộ Tài nguyên và Môi trường, 2016. Kịch bản biến đổi khí hậu, nước biển dâng cho Việt Nam
- [4] 4. Brander, K., 2010. Impacts of climate change on fisheries. *Journal of Marine Systems*. **79**(3): p. 389-402.
- [5] 5. Cao Lê Quyên, Nguyễn Tiến Hưng, Nguyễn Ngọc Hân, 2013. *Đánh giá tác động của biến đổi khí hậu lên hệ thống cơ sở hạ tầng, diện tích, năng suất, sản lượng nuôi trồng thủy sản ven biển nhằm xây dựng các giải pháp tổng hợp và mô hình thử nghiệm phát triển nuôi trồng thủy sản ven biển ứng phó và giảm nhẹ biến đổi khí hậu*, Viện Kinh tế và quy hoạch thủy sản: Hà Nội. p. 142.
- [6] 6. Caviedes, C. and T. Fik, 1992. The Peru–Chile eastern Pacific fisheries and climatic oscillation in *Climate variability, climate change and fisheries*, Glantz, Editor, Cambridge University Press. p. 355-376.
- [7] 7. Cheng, H.-t. and O. Capps, 1988. Demand analysis of fresh and frozen finfish and shellfish in the United States. *American Journal of Agricultural Economics*. **70**(3): p. 533-542.
- [8] 8. Copes, P., 1970. The backward-bending supply curve of the fishing industry. *Scottish Journal of Political Economy*. **17**(1): p. 69-77.
- [9] 9. DARA, C., 2012. *Climate Vulnerability monitor - A guide to the cold calculus of a hot planet*, DARA and Climate Vulnerable Forum, Madrid, Spain.
- [10] 10. Delgado, C.L., 2003. Fish to 2020: Supply and demand in changing global markets. Vol. 62: WorldFish.
- [11] 11. Đinh Văn Ưu, 2010. Sự biến động hoạt động và đổ bộ của bão nhiệt đới vào bờ biển Việt Nam *Tạp chí Khoa học ĐHQGHN, Khoa học Tự nhiên và Công nghệ* **26**( 3S ): p. 479 - 485.
- [12] 12. Economic Commission for Latin America and the Caribbean - ECLAC, 2011. An assessment of the economic impact of climate change on the agriculture sector in Guyana. United Nation.
- [13] 13. FAO, 2016. *The state of world fisheries and aquaculture 2016: Contributing to food security and nutrition for all*. FAO Rome, Italy.
- [14] 14. Farber, S., 1987. The value of coastal wetlands for protection of property against hurricane wind damage. *Journal of Environmental Economics and Management*. **14**(2): p. 143-151.
- [15] 15. IPCC, 2014. *Climate Change 2014: Synthesis Report. Contribution of Working Groups I, II and III to the Fifth Assessment Report of the Intergovernmental Panel on Climate Change*.
- [16] 16. Kahn, J., 1991. Atrazine Pollution and Cheasepeake Fisheries, in *Farming and the Countryside: An Economic Analysis of External Costs and Benefits*, N.Hanley, Editor, CAB International: Oxford.
- [17] 17. Kam, S.P., M.-C. Badjeck, L. Teh, and N. Tran, 2012. Autonomous adaptation to climate change by shrimp and catfish farmers in Vietnam's Mekong River delta.
- [18] 18. Narita, D., K. Rehdanz, and R.S. Tol, 2012. Economic costs of ocean acidification: a look into the impacts on global shellfish production. *Climatic Change*. **113**(3-4): p. 1049-1063.
- [19] 19. Ngô Anh Tuấn và cộng sự, 2013. 50 năm thủy sản Việt Nam. Tổng cục Thủy sản: Nhà xuất bản Nông nghiệp. 244.
- [20] 20. Nguyễn Đức Hiệp, 2006. Khí hậu và hiện tượng El Nino.
- [21] 21. Nguyễn Ngọc Thanh, Nguyễn Việt Thành, Nguyễn Thị Vĩnh Hà, Nguyễn Quốc Việt, 2015. Tác động của biến đổi khí hậu đối với thủy sản miền Bắc. Nhà xuất bản Đại học Quốc gia Hà Nội.
- [22] 22. Nkoro, E. and A.K. Uko, 2016. Autoregressive Distributed Lag (ARDL) cointegration technique: application and interpretation. *Journal of Statistical and Econometric Methods*. **5**(4): p. 63-91.
- [23] 23. Pascoe, S. and S. Mardle, 1999. *Supply response in fisheries-the North Sea*. University of Portsmouth, Centre for the Economics and Management of Aquatic Resources.
- [24] 24. Phạm Quang Hà và cộng sự, 2012. *Đánh giá tác động, xác định các giải pháp ứng phó và triển các kế hoạch hành động trong lĩnh vực nông nghiệp, thủy sản*, Viện Môi trường Nông nghiệp: Hà Nội. p. 79.
- [25] 25. Roessig, J., C. Woodley, J. Cech, Jr., and L. Hansen, 2004. Effects of global climate change on marine and estuarine fishes and fisheries. *Reviews in Fish Biology and Fisheries*. **14**(2): p. 251-275.
- [26] 26. Sumaila, U.R., W.W. Cheung, V.W. Lam, D. Pauly, and S. Herrick, 2011. Climate change impacts on the biophysics and economics of world fisheries. *Nature climate change*. **1**(9): p. 449-456.
- [27] 27. Tổng cục Thống kê, 2015. Niên giám thống kê 2014. Nhà xuất bản Thống kê.
- [28] 28. United Nations, D.o.E.a.S.A., Population Division, 2015 *World Population Prospects: The 2015 Revision*,

Volume I: Comprehensive Tables (ST/ESA/SER.A/379).

- [29] 29. Viện Kinh tế quy hoạch thủy sản, 2012. Báo cáo tóm tắt Quy hoạch tổng thể ngành thủy sản Việt Nam đến năm 2020, tầm nhìn 2030, Tổng cục Thủy sản.
- [30] 30. Weitzman, M.L., 2001. Gamma discounting. *American Economic Review*: p. 260-271.
- [31] 31. Williams, L. and A. Rota, 2010. Impact of climate change on fisheries and aquaculture in the developing world and opportunities for adaptation. Fisheries Thematic Paper: Tool for project design